



PAVEMENT DESIGN MANUAL

November 2018



PREFACE

The Montana Department of Transportation (MDT) Pavement Design Manual has been developed to provide discussion and fundamental principles on pavement design, detailed material information, procedures for designing pavement sections on the range of MDT roadways, and specification information. The Pavement Design Manual was developed by the MDT Surfacing Design Unit. Additional formatting and editorial updates were provided by the transportation engineering consulting firm of Kittelson & Associates, Inc. The Pavement Design Manual Review Committee consisted of:

Jim Davies, P.E.
Darin Reynolds, P.E.
Miles Yerger, P.E.
Mark Studt, P.E.
Andy Daleiden, P.E.
Julia Knudsen, P.E.
Katie Ayer
Erma Halili

MDT Pavement Analysis Engineer
VA Engineer
Surfacing Design Unit Supervisor
MDT – Consultant Design
Kittelson & Associates, Inc.
Kittelson & Associates, Inc.
Kittelson & Associates, Inc.
Kittelson & Associates, Inc.

Table of Contents

- CHAPTER 1:** Introduction
- CHAPTER 2:** Pavement Design Process
- CHAPTER 3:** Pavement Typical Sections
- CHAPTER 4:** Flexible Pavement Design Overview
- CHAPTER 5:** Flexible Pavement Design Method
- CHAPTER 6:** Flexible Pavement Rehabilitation
- CHAPTER 7:** Engineered Overlays
- CHAPTER 8:** Gravel Road Design
- CHAPTER 9:** New and Reconstructed Rigid Pavement Design
- CHAPTER 10:** Rigid Pavement Rehabilitation
- CHAPTER 11:** Pavement Preservation & Scheduled Treatments
- CHAPTER 12:** Bridge End Pavement
- CHAPTER 13:** Traffic Estimation – Special Cases
- CHAPTER 14:** Tools for Pavement Analysis
- CHAPTER 15:** Pavement Economic Analysis
- APPENDICES**

MONTANA DEPARTMENT OF TRANSPORTATION

PAVEMENT DESIGN MANUAL

Chapter 1

Introduction

November 2018



Contents

CHAPTER 1 INTRODUCTION.....	1-1
1.1 Background.....	1-3
1.2 MDT Contacts	1-4



Chapter 1

Introduction

1.1 OVERVIEW

Pavement design is a complex process that requires the designer to analyze data and information from many sources. It is imperative that the designer examine data and design calculations for reasonableness. The guidance provided within this manual is intended to reduce subjectivity in the analysis and design process, without initiating a "cookbook" approach. It does not, nor could it, give inputs for every possible design situation. When the designer varies from these inputs, it is important that the change be noted in the design file. This will allow future designers to recreate any given pavement design.

There was no attempt to make this Pavement Design Manual a user guide for the computer design programs used by the Surfacing Design Unit. There are user manuals available for that purpose. Additionally, discussion regarding design theory is left to the reference manuals.

1.2 HOW TO USE THE MANUAL

The Pavement Design Manual is organized into fifteen chapters that provide discussion and fundamental principles on pavement design, detailed material information, procedures for designing pavement sections on the range of MDT roadways, and specification information. The manual has been formatted to allow for "author notes" in the side margin, which may emphasize specific chapter content, provide supplemental commentary to the discussion, or refer to other sections and/or publications. The following bullets provide a brief overview of each chapter:

- **Chapter 1: Introduction** provides an overview of the Pavement Design Manual and background on the fundamental AASHTO guidance that is used in pavement design. MDT Surfacing Design Unit contacts are also provided.

Author Notes are provided in the margin to emphasize chapter content or to provide supplemental information to the discussion.

- **Chapter 2: Pavement Design Process** provides an overview of the pavement design project activities and project flow charts. This chapter also provides guidance on accessing and using design memorandums.
- **Chapter 3: Pavement Typical Sections** provides information on general characteristics of MDT pavements, alternative pavement sections and flexible pavement material specifications, and additional details on materials and sections.
- **Chapter 4: Flexible Pavement Design Overview** includes information on designing with thick PMS layers and describes pavement failure types. This chapter also provides an overview of pavement layers for staged construction.
- **Chapter 5: Flexible Pavement Design Method** provides information on the 1993 AASHTO Guide flexible pavement design method. The input parameters for this type of design are provided and the steps for flexible pavement design are described.
- **Chapter 6: Flexible Pavement Rehabilitation** includes details on minor and major rehabilitation. Major rehabilitation information includes an overview of pulverization.
- **Chapter 7: Engineered Overlays** provides information on overlays for minor and major rehabilitation and high and low volume roadways. This chapter provides details on engineered overlay design.
- **Chapter 8: Gravel Road Design** provides a brief overview of gravel road design and includes information on detours.
- **Chapter 9: New and Reconstructed Rigid Pavement Design** includes information on concrete pavement design.
- **Chapter 10: Rigid Pavement Rehabilitation** provides an overview of rigid pavement information for minor and major rehabilitation. This also includes other treatments for rehabilitation.
- **Chapter 11: Pavement Preservation and Scheduled Treatments** provides information on a variety of surface treatments. This chapter also includes additional resources on the treatments discussed.
- **Chapter 12: Bridge End Pavement Design** includes information on the design process for this type of pavement design. This includes 30-year bridge end pavement design and reinforced bridge end pavement design.
- **Chapter 13: Traffic Estimation – Special Cases** provides an overview of special cases that may require additional pavement design considerations. These include rest areas, sugar beet truck routes, wheat truck routes and oil production and exploration routes.
- **Chapter 14: Tools for Pavement Analysis** focuses primarily on Non-Destructive Testing. This chapter includes information on other tools such as PathWeb, Ride and Rut information, and others.
- **Chapter 15: Pavement Economic Analysis** describes the life cycle cost analysis used in pavement design.

The following appendices have been developed to supplement the chapter content and provide additional details on procedures, equipment, or software that are not covered in the chapters.

- Appendix A: Sample Traffic Memorandum
- Appendix B: Example Surfacing Design Memorandum
- Appendix C: Memorandum Naming Convention & Saving Procedure
- Appendix D: Flexible Pavement Rehabilitation Design Example
- Appendix E: 1993 AASHTO DARWin 3.1 (Design, Analysis, and Rehabilitation for Windows) - Pavement Reconstruction Design Example
- Appendix F: 1993 AASHTO Spreadsheet Solution
- Appendix G: Acronym List and Website List

The MDT Pavement Design Manual is available as a PDF file that includes all chapters and appendices. Bookmarks are included for ease of tracking between chapters and sections. The search function within the PDF viewing browser may be used to locate specific terms throughout the manual.

1.3 BACKGROUND

Historically, pavement design has been an empirical procedure in which engineering judgment and experience have played an integral part. In 1962, the American Association of State Highway Officials (AASHO) issued an interim design guide. This guide presents an empirical pavement design method based on the well-known AASHO road test that took place in the 1950s in Ottawa, Illinois. Updates to the 1962 Guide are described below.

In 1986, the American Association of State Highway and Transportation Officials (AASHTO), name changed from AASHO in 1973, issued a more comprehensive guide titled *AASHTO Guide for Design of Pavement Structures (1)*. This guide addresses a greater number of design parameters. The idea of mechanistic-empirical (M-E) design procedures was also introduced at this time. Personal computers began to replace nomographs in the design procedures, and AASHTO introduced DNSP86, a computerized design procedure to be used in conjunction with the *AASHTO Guide for Design of Pavement Structures*. Some state agencies began incorporating non-destructive testing (NDT) in to pavement design.

In 1991, AASHTO released a pavement design software package titled Design Analysis and Rehabilitation for Windows (DARWin).

A new version of DARWin was released in 1993 along with a revised edition of *AASHTO Guide for Design of Pavement Structures (1993 Guide)*. ((2) *AASHTO, 1993*) MDT currently uses a pavement design method based on the 1993 Guide and DARWin software, with adjustments made to consider MDT's past experience and pavement materials.

Today, the pavement design industry is slowly migrating to M-E pavement design. AASHTO has endorsed a software package titled AASHTO M-E Pavement Design (AASHTO M-E). MDT conducted a comprehensive study (VonQuitus, 2007) to calibrate the pavement performance models found within a previous version of AASHTO M-E. Unfortunately, the study did not result in a reliable M-

MDT will continue to work towards using AASHTO M-E or another M-E design method, but for the time being, designers should continue to use this manual for routine pavement designs.

E design method. In addition, in the summer 2014, MDT's Surfacing Design Unit performed a thorough comparison of the 1993 Guide method versus MEPDG and came to a similar conclusion that at this time, MDT is not ready to switch to MEPDG. MDT will continue to work towards utilizing AASHTO M-E or another M-E design method, but for the time being, designers should continue to use this manual for routine pavement designs.

1.4 MDT CONTACTS

Pavement Analysis Engineer, (406) 444-3424

Pavement Design Engineer, (406) 444-7650

Surfacing Design, (406) 444-7606; (406) 444-6707

1.5 REFERENCES

1. American Association of State Highway Officials (AASHTO). *Guide for Design of Pavement Structures*. AASHTO, Washington, D.C., 1986
2. AASHTO. *Guide for Design of Pavement Structures*. AASHTO, Washington D.C., 1993.

MONTANA DEPARTMENT OF TRANSPORTATION

PAVEMENT DESIGN MANUAL

Chapter 2

Pavement Design Process

November 2018



Contents

CHAPTER 2 PAVEMENT DESIGN PROCESS	2-1
2.1 Introduction	2-1
2.2 Project Flowcharts	2-2
2.3 Pavement Preservation Flowchart	2-6
2.4 Consultant Design Project Flowchart	2-9
2.5 Design Memorandums	2-12
2.6 References	2-12



Chapter 2

Pavement Design Process

2.1 INTRODUCTION

MDT uses Engineering Project Scheduler (EPS) computer software for project management. Designers are EPS Functional Managers, responsible for updating the status of the surfacing design activities. Details of EPS are beyond the scope of this manual. However, it is important to outline the designer's responsibilities for updating EPS, which are to ensure that:

- There are no late activities on the critical path.
- Activities are updated regularly. EPS should be checked and updated no less than every two weeks.
- Projects do not appear on the Status Compliance Report more than once during a calendar year with activities updated for more than two weeks.

The Surfacing Design EPS activities are separated into MDT-designed projects and consultant-designed projects, as shown below.

MDT-Designed Projects:

- Activity 600: Prepare Preliminary Surfacing Typical Section
- Activity 602: Provide Deflection Data – Non-Destructive Testing (NDT)
Unit is responsible for this Activity
- Activity 604: Final Surfacing Sections
- Activity 610: Final Surfacing Design Check

Consultant-Designed MDT Projects:

- Activity 440: Preliminary Geotech and Materials Review
- Activity 442: Geotechnical and Materials Report Review
- Activity 444: Materials and Geotech Final Review
- Activity 608: Provide Deflection Data - NDT Unit is responsible for this Activity

The following flowcharts and activity descriptions describe the Surfacing Design Unit's role within the roadway design process. The flowcharts were developed using the EPS flowcharts published by the Engineering Division's Engineering Information Systems Section. The flowcharts can be found at the following MDT websites:

[MDT-Designed Projects](#)

[Consultant-Designed MDT Projects](#)

Activity information provided throughout this chapter should be confirmed with the current descriptions found at the MDT website.

2.2 PROJECT FLOWCHARTS

The flowchart shown in Exhibit 2-1 describes the Surfacing Design Unit's roles and activities within the overall project design. This does not include pavement preservation and consultant design projects.

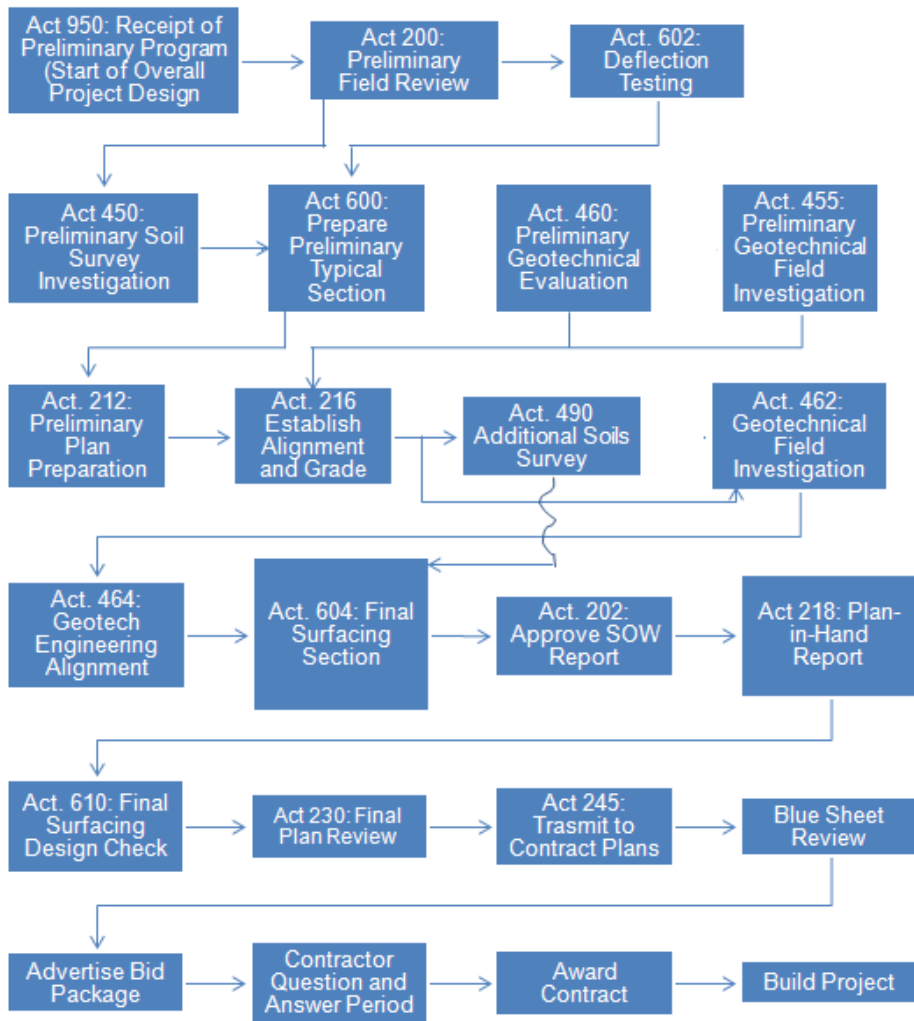

**Exhibit 2-1
New Construction,
Reconstruction, Major
Rehabilitation, and Overlay
and Widening Design
Flowchart**

Activity 950: Receipt of Preliminary Program. Shown for information only. This activity establishes a project charge number to monetarily charge MDT design time to and is the point of time when preliminary engineering begins for a project.

Activity 200: Preliminary Field Review (PFR). A Surfacing Design Unit representative is required to attend all pavement preservation, chip seal, overlay, mill/fill, and minor and major pavement rehabilitation projects. The PFR is an on-site meeting early in the design process during which the project scope, including the type of pavement treatment to be used, is preliminarily developed. The PFR is attended by Headquarters and District designers and engineers, and it culminates in a PFR report that is distributed for comment. The PFR report is considered a “milestone” report.

Additional information regarding Activity 602 can be found in the MDT Non-Destructive Testing Manual (1).

The designer should gather and examine the following information before the PFR:

- Project limits
- Pavement management system (PvMS) information
- As-built pavement typical section
- Construction history (Pavement management is one location from which this information can be obtained.)
- Ride, rut, and cracking indices
- NDT information
- Falling weight deflectometer (FWD) results (if applicable)
- Ground penetrating radar (GPR) results (if applicable)
- Soils information
- Soil survey from previous project (if applicable)

Activity 602: Deflection Testing. This is a prerequisite of Activity 600. This is the NDT Unit's only EPS activity. This activity includes falling weight deflectometer (FWD) and ground penetrating radar (GPR) pavement testing, as well as processing the test data. Processing the data refers to calculating pavement layer resilient modulus (M_R) and thicknesses.

Activity 450: Preliminary Soil Survey Investigation. This is a prerequisite to Activity 600. The preliminary soil survey is done by the District Materials Laboratory and refers to boring the existing pavement and/or new alignment to determine both thicknesses and quality of the pavement and subgrade materials. Borings are normally done at ½-mile intervals in alternating lanes, but can be reduced to one-mile intervals when supplemented with FWD and GPR (Activity 602). The soil survey is conducted as specified in MT-207 of the Materials Manual and reported within the Site Manager computer program or Lab Form 111.

The project scope will determine the level of soil survey required to develop the project.

If the project is a reconstruct, the soil survey should primarily consist of a subgrade soil survey. The designer will develop the new typical section based on the subgrade results. Any information on the base is useful, and composite samples should be performed on the base gravel.

If the project is a pulverization project, the soil survey should consist of both the subgrade and base course information.

Activity 600: Prepare Preliminary Typical Section. This is the Surfacing Design Unit's major design activity. This activity involves retrieving, organizing, and analyzing information to design the preliminary pavement section for a given road project. Details of the process are described throughout this design manual. The conclusion of this activity is sending the preliminary surfacing memorandum to both Headquarters and District road design staff.

Activities 455 and 465: Preliminary Geotechnical Evaluation and Field Investigation. Shown for information only. This information can be requested from the Geotechnical Section as needed by the designer to supplement the information provided in Activities 450 and 602.

Activities 212 and 216: Preliminary Plan Preparation and Establish Alignment and Grade. Shown for information only. The preliminary typical section (Activity 600) is a predecessor for both of these Road Design activities. The designer should be aware of the effect that Activity 600 has on these activities and the overall project schedule.

Activity 490: Additional Soils Survey. After the roadway alignment and grade have been set within the Alignment and Grade report, the District Materials Lab may need to retrieve additional soils and pavement information in locations that were not bored during the preliminary soils survey (Activity 450). The designer should review the alignment and grade report and request additional soil survey as needed for the Final Surfacing Section (Activity 604). Usually, the preliminary soil survey is adequate for pavement design, and Activity 490 does not occur. Note that it is the *designer's responsibility to request additional soils survey* when needed.

Activities 462 and 464: Geotechnical Field Investigation and Engineering Alignment. Shown for information only. The designer can request this information from the Geotechnical Section as needed to supplement the information provided in Activities 450, 490, and 602.

Activities 222 and 604: Approve Scope of Work (SOW) Report and Final Surfacing Section. The Scope of Work (Activity 214) is a project milestone report in which the design scope of a given project is defined. The report includes the preliminary typical section. Activity 604 consists of the designer checking the typical section and pavement materials described in the SOW report for accuracy and completion. When the information is correct, the designer should “card-off” the activity in EPS. If revisions are needed, a final surfacing design memorandum showing the revised surfacing section is prepared and sent to Headquarters and District Road Design staff.

Activities 218 and 610: Plan-in-Hand Report and Final Surfacing Design Check. The Plan-in-Hand Report (Activity 218) is a project milestone report in which the plans are thoroughly reviewed. Activity 610 consists of the designer checking the typical section and pavement materials described in the PIH report for accuracy and completion, especially considering additional information that became available since the final surfacing design (Activity 604) was completed. When the information is correct, the designer should “card-off” the activity in EPS. If revisions are needed, an email or memorandum outlining the revisions is prepared and sent to Headquarters and District Road Design staff.

Activity 230: Final Plan Review. Shown for information only. The final plan review is a mail/email distribution of the project plans, specifications, and cost estimate when the overall design is 90% complete. The distribution should be reviewed for accuracy, but the designer should not make comments at this stage unless absolutely necessary and after consulting with the materials engineer. The reason for this is that comments and/or changes made to the plans at this point may delay project delivery.

Activity 245 and Blue Sheet Review. Shown for information only. Preconstruction submits the bid package to contract plans three months before it is scheduled to be released to contractors for bidding. During the three months, the last project review occurs when the contract plans distributes the “blue sheet” bid

It is the designer's responsibility to request additional soil survey when needed.

package which is literally the bid package printed on blue paper. The distribution should be reviewed for accuracy, but the designer should not make comments at this stage unless absolutely necessary and after consulting with the materials engineer. The reason for this is that comments and/or changes made to the plans at this point may delay project delivery.

Advertise Bid Package, Contractor Question and Answer Period, and Award Contract. Shown for information only. When the project is advertised for award (or “letting”), there is a question and answer (Q&A) period during which contractors can ask questions regarding the bid package. The Q&A may result in changes to the bid package. The Surfacing Design Unit is routinely involved in answering or advising on questions submitted during the Q&A period. In the event that a contractor contacts the designer directly with questions, they need to be directed to submit their questions through the Q&A system for a response. This allows for all potential bidders to have the same information.

Build Project. Shown for information only. During construction, the Surfacing Design Unit is routinely called upon to advise regarding surfacing sections and materials. Time devoted to this should be billed to the project’s 9402 account with no activity number. Work done on projects under construction should be done quickly and take priority since construction delays are costly to both MDT and contractors.

2.3 PAVEMENT PRESERVATION FLOWCHART

Pavement Preservation projects are pavement treatments meant to preserve pavements that are in good condition. It is the intent of MDT to nominate, design, and let these projects in less than two years. This allows for the project to be built with the appropriate scope before the pavement deteriorates into a poorer condition and may no longer be a pavement preservation candidate. The project is developed as shown in the Pavement Preservation flow chart at the following MDT website:

[Pavement Preservation Flow Chart](#) (Internal Intranet only)

The Surfacing Design Unit normally gets involved in these projects starting with the preliminary field review.

Of particular importance is the method of pavement preservation chosen. The project treatment should be the same as, or one category different (above or below) from, what is recommended in the MDT Annual [Pavement Performance and Condition Report](#) (2). For example, if the report specifies that a thin overlay is needed, the project treatment should be one step below, the same, or above (a chip seal, thin overlay, or minor rehabilitation, respectively). The MDT Annual Pavement Performance and Conditions Report is located at the following MDT website:

[MDT Annual Pavement Performance and Conditions Report](#)

A more thorough discussion of MDT’s policy regarding scoping pavement preservation projects can be found at the following MDT website:

[MDT Policy for Scoping Pavement Preservation Projects](#)

Error! Reference source not found.The Pavement Preservations flow chart(s) show the surfacing design related activities that occur during Pavement Preservation project design. The activities are discussed further in the following paragraphs.

District Nomination/Pavement Management Review. For information only. Generally, the District nominates projects based on their needs along with the recommended treatment published annually in the Pavement Performance and Condition Report. After the nomination, the pavement management supervisor/engineer inspects the project and approves or disapproves the nomination.

Activity 950: Receipt of Preliminary Program. Shown for information only. This activity establishes a project charge number to monetarily charge MDT design time to and is the point of time when preliminary engineering begins for a project.

Activity 250: Prepare PFR/SOW Report. Although there is not an EPS activity for it, a preliminary field review occurs on pavement preservation projects. A Surfacing Design Unit representative is required to attend pavement preservation PFRs. The PFR is an on-site meeting early in the design process in which the project scope is preliminarily developed, including the type of pavement treatment to be used. For example, if the nomination scope is an overlay, attendees at the PFR may observe the pavement and define the overlay as a 0.20-ft. Grade S overlay. The PFR is attended by Headquarters and District designers and engineers, and it culminates in a PFR report that is distributed for comment, or a combination PFR/SOW report.

Activity 451: Surfacing Cores & Investigation. This activity consists of taking pavement cores and measuring for thickness and for stripping analysis. Plant mix cores should be requested by the designer through the road design project manager. The cores are usually taken by the District materials lab at ½-mile intervals in alternating lanes. Pavement coring and strip testing are done in accordance with MT 331 within the Materials Manual (3). As a “rule of thumb”, cores should be taken as follows:

- All mill/fill projects
- On all pavement preservation overlays and mill/fills on roadways with more than 300 daily ESALs > 300
- On any in-place recycling projects (cold in-place recycle and hot in-place recycle). Double the core frequency and retain ½ the cores for bidding.

The purpose of the cores is to:

- **Specify the milling depth** – It is undesirable to mill Plant Mix Surfacing (PMS) just above or below an existing boundary between PMS lifts. This may result in a rough finished milled surface.
- **Ensure that milling is feasible** – At least an inch of PMS should remain in place after milling to carry traffic during construction.
- **Ensure that milling isn’t occurring in overly stripped PMS** – Milling into stripped PMS may result in a rough milled surface. Generally, milling should only be done in material with an average stripping test grade ≥ 1.2 .
- **Ensure that an overlay is not being placed directly on overly stripped PMS** – Placing PMS overlays on stripped plant mix (stripping grade less

than or equal to 1) is not recommended. The underlying PMS may not have adequate strength to support the new overlay. This may not hold true on very low volume roads where overlaying stripped plant mix may be possible due to low truck loading.

- **Allow the recycling contractor to obtain information on existing pavement** - Including aggregate size, fracture and oil content. A mix design can also be performed using cores.

Activity 602: Deflection Testing. Often, this activity is only done on mill/fill projects to determine the in-place PMS thickness using GPR in order to specify milling depths. For pavement preservation projects, FWD data is usually not needed since by definition the pavement should be in good condition.

Activity 600: Prepare Preliminary Typical Section. This is the Surfacing Design Unit's major design activity. This activity involves retrieving, organizing, and analyzing information to design the preliminary pavement section for a given road project. Details of the process are described throughout this design manual. The conclusion of this activity is sending the preliminary surfacing memorandum to both Headquarters and District road design staff.

Activities 230: Final Plan Review. Shown for information only. The final plan review is a mail/email distribution of the project plans, specifications, and cost estimate when the overall design is 90% complete. The distribution should be reviewed for accuracy, but the designer should not make comments at this stage unless absolutely necessary and after consulting with the materials engineer. The reason for this is that comments and/or changes made to the plans at this point may delay project delivery.

Activity 245 and Blue Sheet Review. Shown for information only. Preconstruction submits the bid package to contract plans three months before it is scheduled to be released to contractors for bidding. During the three months, the last project review occurs when the contract plans distributes "blue sheet" bid package which is literally the bid package printed on blue paper. The distribution should be reviewed for accuracy, but the designer should not make comments at this stage unless absolutely necessary and after consulting with the materials engineer. The reason for this is that comments and/or changes made to the plans at this point may delay project delivery.

Advertise Bid Package, Contractor Question and Answer Period, and Award Contract. Shown for information only. When the project is advertised for award (or "letting"), there is a question and answer (Q&A) period during which contractors can ask questions regarding the bid package. The Q&A may result in changes to the bid package. The Surfacing Design Unit is routinely involved in answering or advising on questions submitted during the Q&A period. In the event a contractor contacts the designer directly with questions, they need to be directed to submit their questions through the Q&A system for a response. This allows all potential bidders to have the same information.

Build Project. Shown for information only. During construction, surfacing design routinely is called upon to advise regarding surfacing sections and materials. Time devoted to this should be billed to the project's 9402 account with no activity number. Work done on projects under construction should be done

quickly and take priority since construction delays are costly to both MDT and contractors.

2.4 CONSULTANT DESIGN PROJECT FLOWCHART

Often, MDT contracts with engineering consultants to design and prepare bid packages for MDT projects. On these projects, a consultant design engineer administers the project and acts as a liaison between MDT and the consultant. That being the case, *all project communication with the consultant must be done through the consultant design engineer responsible for the project.*

On these projects, the Surfacing Design Unit's duty does not include design work, but rather reviewing the consultant's pavement reports, calculations, plans and specifications to ensure that they are designed and specified in accordance with MDT policies and procedures. **Error! Reference source not found.** Exhibit 2-2 contains a flow chart showing the consultant activities integrated with MDT pavement design activities.

Consultant design EPS activities of direct interest to the Surfacing Design Unit include:

- Activity 440: Preliminary Geotech & Materials Review
- Activity 442: Geotechnical & Materials Report Review
- Activity 444: Materials and Geotech Final Review
- Activity 608: Provide Deflection Test Data – NDT Unit responsible for this Activity

All project communication with the consultant must be done through the consultant design engineer responsible for the project.

**Exhibit 2-2
Consultant Design
Project Flowchart**

**Note: Yellow font
indicates consultant
activity.**

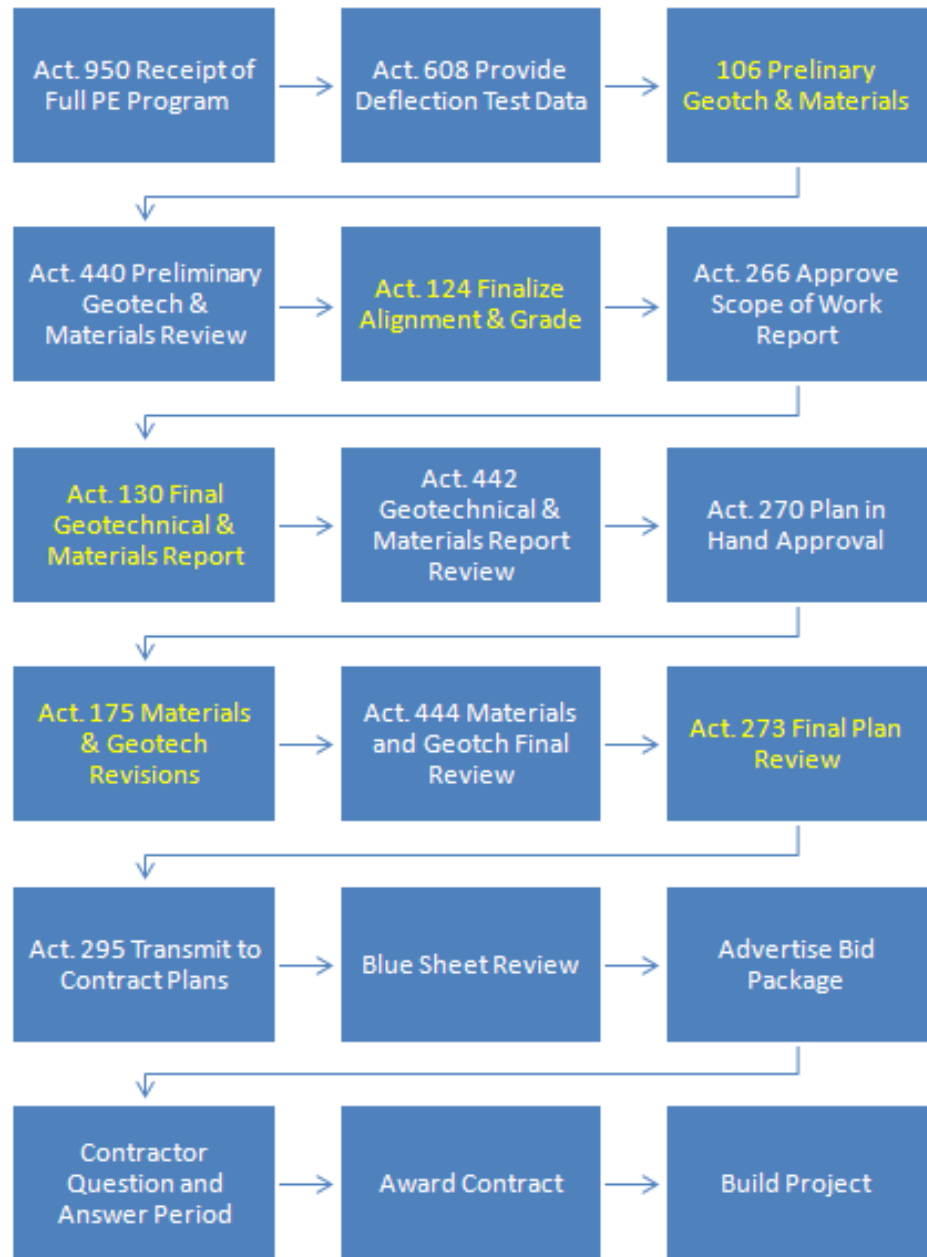

Activity 950: Receipt of Preliminary Program. This activity establishes a project charge number to monetarily charge MDT design time to and is the point in time when preliminary engineering begins for a project.

Activity 440: Preliminary Geotech & Materials Review. The design consultant completes this activity. This activity includes:

- Preliminary Soil Survey Investigation
- Borrow Pit Investigation
- Surfacing Pit Investigation
- Prepare Preliminary Surfacing Typical Sections
- Deflection Analysis
- Preliminary Geotechnical Evaluation

Activity 106: Preliminary Geotech & Materials. This refers to MDT's review of the Activity 440 report for accuracy and completion. The Surfacing Design Unit reviews the pavement related portion of the report including the soil survey investigation, preliminary surfacing typical sections, and the deflection analysis. Comments on the report should be sent via email to the District, Materials Bureau, and the consultant design project manager.

Activities 124 and 266: Finalize Alignment & Grade and Approve Scope of Work Report. For information only. Defines the project scope.

Activity 130: Final Geotechnical & Materials Report. The design consultant completes this activity including:

- Prepare Final Surfacing Sections
- Primary Soils Survey
- Geotechnical Surveys and Field Investigation
- Geotechnical Engineering – Alignment

Activity 442: Preliminary Geotech & Materials. This refers to MDT's review of the Activity 130 report for accuracy and completion. The Surfacing Design Unit reviews the pavement related portion of the report including the final surfacing sections and primary soils survey. Comments on the report should be sent via email to the District, Materials Bureau, and the consultant design project manager.

Activity 273: Final Plan Review. Shown for information only. The final plan review is a mail/email distribution of the project plans, specifications, and cost estimate when the design is approximately 90% complete. The distribution should be reviewed for accuracy, but at this stage, the designer should not make comments that significantly alters the design unless absolutely necessary and after consulting with the materials engineer. The reason for this is that comments and/or changes made to the plans at this point may delay project delivery.

Activity 444: Materials and Geotech Final Review This activity serves as consultation for finalizing any changes for final plan review.

Activity 608: Provide Deflection Test Data: The NDT unit is responsible for this activity. Upon request, the NDT unit will provide FWD and GPR data to the design consultant. It should be noted project level NDT data can only be collected when weather permits during spring and fall.

2.5 DESIGN MEMORANDUMS

The surfacing designer should be aware of the Design Memorandums posted at the following MDT website:

[MDT Design Memorandums](#)

Design memorandums provide additional guidance and take precedence over what is printed in the Road Design Manual and the Pavement Design Manual.

The surfacing designer should also be aware of the Construction Memorandums posted at the following MDT website:

[MDT Construction Memorandums](#)

Construction Memorandums provide guidance on topics such as chip seals and subgrade sampling.

2.6 REFERENCES

1. Montana Department of Transportation (MDT). Non-Destructive Testing Manual. MDT, Helena, MT, 2018.
2. MDT. Annual Pavement Performance and Condition Report. MDT, Helena, MT, current year.
3. MDT. Materials Manual. MDT, Helena, MT, 2017.

MONTANA DEPARTMENT OF TRANSPORTATION

PAVEMENT DESIGN MANUAL

Chapter 3

Pavement Typical Sections

November 2018



Contents

CHAPTER 3 PAVEMENT TYPICAL SECTIONS	3-1
3.1 Introduction	3-1
3.2 General Characteristics of MDT Pavements	3-2
3.3 Alternate Pavement Sections	3-5
3.4 Flexible Pavement Material Specifications	3-5
3.4.1 PMS Type Selection	3-5
3.1.2 Reclaimed Asphalt Pavement	3-8
3.1.3 Performance Grade (PG) Binder	3-9
3.1.4 Asphalt Content Selection	3-12
3.1.5 Pavement Base Course	3-13
3.5 Crushed Aggregate Course	3-13
3.6 Cement Treated Base	3-13
3.6.1 Pavement Subbase Course	3-14
3.7 Typical Sections Utilizing Geosynthetics	3-14
3.8 Rigid Pavement Material Specifications	3-15
3.9 References	3-15



Chapter 3

Pavement Typical Sections

3.1 INTRODUCTION

MDT predominantly uses flexible pavements which it refers to as plant mix surfacing (PMS). In rare instances, MDT uses rigid pavement, commonly referred to as Portland cement concrete pavement (PCCP). Currently, flexible pavements make up about 97% of MDT's road system (excluding gravel roads).

A flexible pavement can consist of up to four layers -- subgrade, subbase (often omitted), base, and surfacing. These pavement layers are described as follows:

- Surfacing usually consists of PMS. Historically, some low-volume gravel roads started out with a double shot (double chip seal) or compacted millings. PMS is typically chip sealed, except when specifically designed to be less permeable such as 3/8 in. Grade S PMS.
- The base course usually consists of an untreated gravel base or cement-treated base.
- Subbase can consist of a sand surfacing, special borrow, or uncrushed gravel placed on the subgrade.
- Subgrade is the native material beneath the surfacing section.

Rigid pavement is PCCP placed upon a granular, stabilized base, or PMS. MDT currently uses jointed plain concrete pavement (JPCP). Rigid pavement is mostly used on roadways with the following:

- High annual daily traffic (ADT) and/or truck traffic
- Recurring PMS rutting problems
- Slow moving or stop-and-go traffic
- Signalized intersections
- Roundabouts

Flexible pavement can consist of up to four layers – subgrade, subbase, base, and surfacing.

MDT's flexible pavement design method is based on the 1993 AASHTO Guide for the Design of Pavement Structures.

The design method outlined within this section assumes that the existing road will not be used in-place as part of the new pavement. This includes both new and reconstructed pavements defined as follows:

New Pavement - A new pavement is a pavement structure that is placed on a previously undisturbed subgrade. It applies to a highway on a new alignment or to the new part of a widened highway. Often, these projects are needed to update old roadways to new geometric standards.

Reconstructed Pavement - A reconstructed pavement refers to completely removing an existing pavement structure and replacing it with a new pavement structure. This type of work is needed when the existing pavement is in a weakened condition that it cannot be salvaged. Also, these projects are often needed to update old roadways to new geometric standards.

MDT's flexible pavement design method is based on the 1993 AASHTO *Guide for the Design of Pavement Structures* (1993 Guide) ((1)AASHTO, 1993). MDT has incorporated several modifications to the 1993 Guide to reflect specific Montana conditions and past experience.

3.2 GENERAL CHARACTERISTICS OF MDT PAVEMENTS

The following exhibits show typical sections from a sample of MDT road plans. In all instances, note that the PMS, base course, and special borrow are of uniform thickness across the entire pavement (i.e. the shoulders are not built thinner).

Exhibit 3-1 Typical Rural Flexible Pavement

This exhibit shows MDT's most common pavement type consisting of PMS under laid with crushed aggregate course (CAC). Note that the pavement layers have 2% cross slopes and daylight out of the side of the pavement inslopes. The purpose of this is to facilitate the drainage of water laterally towards roadside ditches. Seal & cover is placed on top of most flexible pavements, except those covered with plant mix seal or 3/8 in. Grade S PMS.

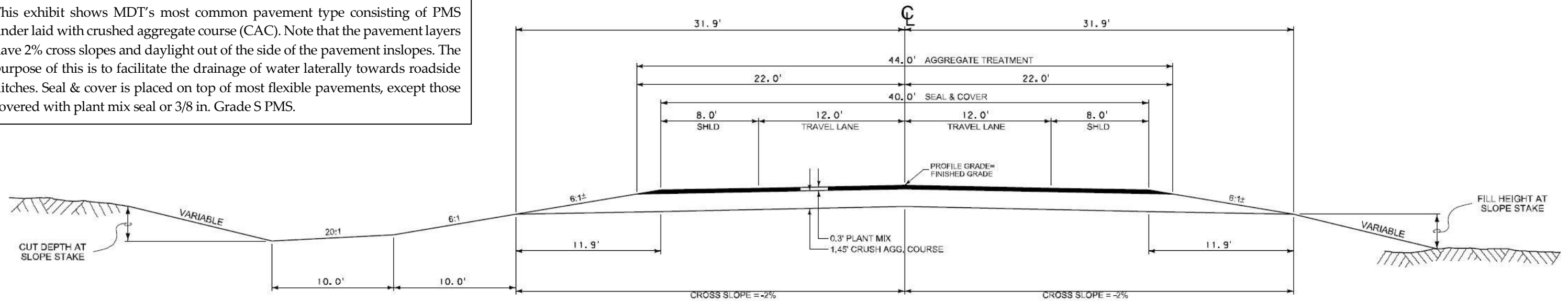

Exhibit 3-2 Typical Urban Flexible Pavement

This exhibit shows the most common urban pavement. Note that the urban pavement layers do not daylight. Edge drains may be used to facilitate drainage depending on soil characteristics.

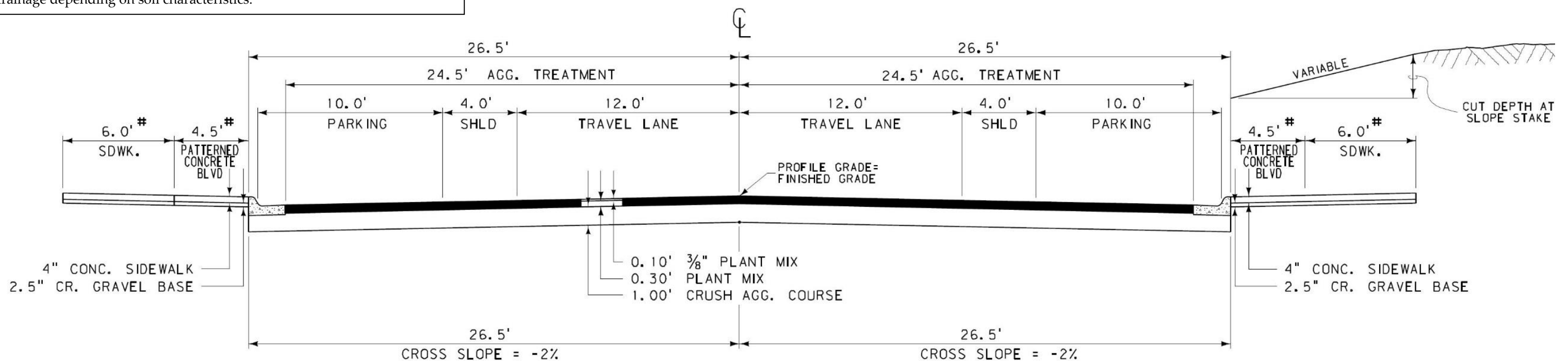

Exhibit 3-3 Typical Flexible Pavement with Special Borrow

This exhibit shows a pavement with a standard 2 ft. layer of special borrow beneath it. Special borrow is often used to decrease CAC thickness or to “bridge” soft subgrades. It usually consists of pit-run gravel, but may consist of other granular materials in gravel-poor areas. **Special borrow pavements are designed using the resilient modulus (M_R) of the special borrow when a minimum of 2 ft. of special borrow is used. Typically, it is assumed up to five feet of the underlying subgrade will influence the M_R of the special borrow. Care should be taken to select an appropriate M_R which accounts for the stiffness of the underlying subgrade.**

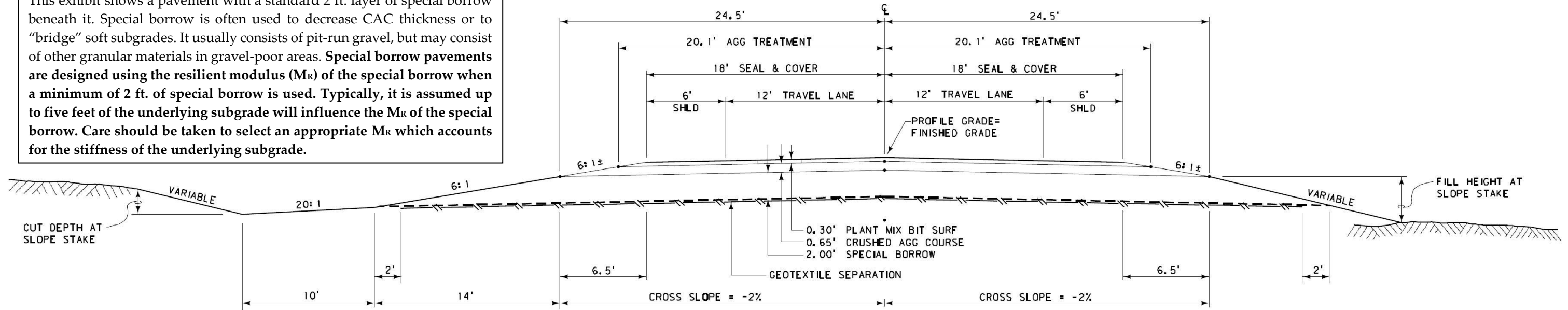
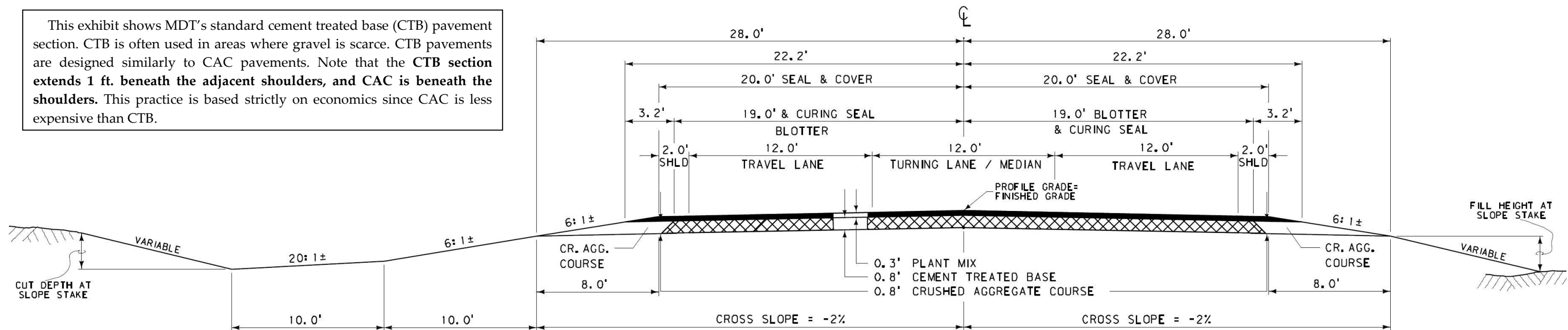

Exhibit 3-4 Typical Cement Treated Base CTB Pavement

This exhibit shows MDT's standard cement treated base (CTB) pavement section. CTB is often used in areas where gravel is scarce. CTB pavements are designed similarly to CAC pavements. Note that the **CTB section extends 1 ft. beneath the adjacent shoulders, and CAC is beneath the shoulders.** This practice is based strictly on economics since CAC is less expensive than CTB.



3.3 ALTERNATE PAVEMENT SECTIONS

The use of alternate typical sections can increase competition and reduce the possibility of Value Engineering (VE) proposals by contractors. This refers to bid documents that include multiple typical sections with different pavement types or materials and allow the contractor to bid on the alternate that is most cost effective. Examples of alternate typical sections are crushed aggregate course (CAC) vs. cement treated base (CTB) and flexible (asphalt) vs. rigid (concrete) pavements. Due to the variance in typical thicknesses, the designer will need to develop alternate plan and profile sheets to match bridge ends, approaches and other fixed elevations. In addition, alternate typical sections may affect grading quantities, hydraulic features, and construction limits. The benefits of alternate sections must be weighed against the additional resources and time required to develop multiple designs.

3.4 FLEXIBLE PAVEMENT MATERIAL SPECIFICATIONS

Specifying the pavement materials to use within the pavement structure is an important part of pavement design. The following section gives guidance on selecting pavement materials.

3.4.1 PMS Type Selection

The designer is responsible for recommending PMS type, aggregate size, asphalt cement type, asphalt cement quantity, and the use of recycled asphalt concrete. MDT's primary surfacing type is Grade S; the "S" denotes that the mixture design is done according to the Superpave mix design procedure. Grade S can consist of three different aggregate sizes: $\frac{3}{4}$ in., $\frac{1}{2}$ in., and $\frac{3}{8}$ in. The size refers to the "nominal maximum aggregate size," or the sieve size one size greater than the first sieve to hold 10% or more aggregate by weight. PMS type is selected primarily based on project quantity **Error! Reference source not found.** and project application **Error! Reference source not found.**. Exhibit 3-5 provides information on the PMS type selection based on project quantity and lift thickness. Exhibit 3-6 provides a basis of plan quantities for flexible pavement.

**Exhibit 3-5
PMS Type Selection Based On
Project Quantity and Lift
Thicknesses**

1Project Quantity	PMS Type (Bid Item)	Lift Thickness	
		Min ~ Max	Recommended
≥ 5,000 tons ¹	Plant Mix Surf Gr S – 3/8 in	0.10 ~ 0.20'	0.10'
	Plant Mix Surf Gr S – 1/2 in	0.12 ~ 0.25'	0.15'
	Plant Mix Surf Gr S – 3/4 in	0.15 ~ 0.30'	0.15 ~ 0.20'
< 5,000 tons ¹	Commercial Plant Mix-PG 70-28 ²	0.15 ~ 0.30'	0.15 ~ 0.20'
	Commercial Plant Mix-PG 64-28	0.15 ~ 0.30'	0.15 ~ 0.20'
	Commercial Plant Mix-PG 58-28	0.15 ~ 0.30'	0.15 ~ 0.20'
	3/8" Grade S – PG 70-28	0.10 ~ 0.20'	0.10'
	3/8" Grade S – PG 64-28	0.10 ~ 0.20'	0.10'

¹ Consider the total contract quantity when multiple projects are tied for letting. Different bid items are used for commercial and non-commercial plant mix. This affects how the oil and lime are paid as well as how Quality Assurance (QA) testing is conducted. QA incentive and disincentive differ for commercial and non-commercial mix.

² Choose binder type based upon the "PG Binders" section within this manual.

**Exhibit 3-6
Basis of Plan
Quantities for Flexible
Pavements**

BASIS OF PLAN QUANTITIES (QUANTITIES FOR ESTIMATING PURPOSES ONLY)		
COMP. AGGREGATE WEIGHT		= 3700 LBS. PER CUBIC YARD
COMP. WEIGHT OF PL. MIX BIT. SURF.		= 3855 LBS. PER CUBIC YARD
COMP. WEIGHT OF CTB =		3625 LBS. PER CUBIC YARD
ASPHALT CEMENT – GRADE S – 3/4" AGG.		= 5.4% OF PL. MIX BIT. SURF.
ASPHALT CEMENT – GRADE S – 1/2" AGG.		= 5.8% OF PL. MIX BIT. SURF.
ASPHALT CEMENT – GRADE S – 3/8" AGG.		= 6.2% OF PL. MIX BIT. SURF.
HYDRATED LIME		= 1.4% OF PL. MIX BIT. SURF.
BITUMINOUS MATERIAL		= 8.5 LBS. PER GAL.
MICROSURFACING AGGREGATE WEIGHT (RUT FILLING)		= 30 LBS per square yard
MICROSURFACING AGGREGATE WEIGHT (SCRATCH COURSE)		= 30 LBS per square yard
MICROSURFACING AGGREGATE WEIGHT (SURFACING COURSE)		= 30 LBS per square yard
MICROSURFACING ASPHALT EMULSION (RUT FILLING)		= 11.5% OF MICRO. AGG.
MICROSURFACING ASPHALT EMULSION (SCRATCH COURSE)		= 11.5% OF MICRO. AGG.
MICROSURFACING ASPHALT EMULSION (SURFACING COURSE)		= 11.5% OF MICRO. AGG.
SEAL		= 0.42 GAL. PER SQ. YARD
COVER		= 25 LBS. PER SQ. YARD
BLOTTER		= 15 LBS. PER SQ. YARD
EMULSIFIED ASPHALT FOGSEAL (S&C)		= 0.075 GAL. PER SQ. YARD (UNDILUTED)
EMULSIFIED ASPHALT TACK (ASPHALT SURFACES)		= 0.025 GAL. PER SQ. YARD (UNDILUTED)
EMULSIFIED ASPHALT TACK (ALL OTHER SURFACES)		= 0.05 GAL. PER SQ. YARD (UNDILUTED)
EMULSIFIED ASPHALT FOGSEAL (RUMBLE STRIPS)		= 0.10 GAL. PER SQ. YARD (UNDILUTED)

Choosing PMS type based on planned quantity requires estimating the total PMS tonnage on a project. Use the following equation, along with the information in Exhibit 3-5 to estimate the asphalt tonnage on a project:

$$\begin{aligned} & \text{Project Length (miles) / project} \times 5280 \text{ ft. / mile} \times \text{Roadtop Width (ft.)} \\ & \times \text{PMS thickness (ft.)} \times 1 \text{ yd}^3/27 \text{ ft}^3 \times 3855 \text{ lbs. / yd}^3 \times 1 \text{ ton PMS / 2000 lbs.} \\ & \qquad \qquad \qquad = \text{tons PMS / project} \end{aligned}$$

There are three major differences between Plant Mix Surf Gr S – #/# in. and Commercial Plant Mix:

- **Plant Mix Surf Gr S – #/# in.** quality control/quality assurance (QC/QA) usually results in a superior, more consistent product. However, to use this QC/QA method, the quantity has to be over 5,000 tons. Commercial plant mix utilizes a different method of QC/QA.
- **For Plant Mix Surf Gr S – #/# in.** payment for asphalt cement and hydrated lime are separate from the payment for PMS aggregate. For commercial plant mix, payment for PMS aggregate includes asphalt cement and hydrated lime.
- **For commercial plant mix**, the contractor may choose to use $\frac{3}{4}$ in. Grade S or $\frac{1}{2}$ in. Grade S. The PMS aggregate type is stipulated in the bid item title.

In situations where a chip seal is not desired or would not normally be placed, such as on bike paths, $\frac{3}{8}$ in. Grade S is preferred though more expensive than $\frac{1}{2}$ in. or $\frac{3}{4}$ in. mix. If different nominal maximum aggregate sizes (NMAS) are selected, a bid item (and mix design) will be required for each mix. Each mix design may cost around \$5,000 (2018 USD). Exhibit 3-7 provides information on the PMS type selection based on project type.

**Exhibit 3-7
PMS Type Selection Based On
Project Type**

Project Type	PMS Layer Thickness	PMS Type
Reconstruct, Major Rehab, and Widening	PMS thickness <0.30'	Plant Mix Surf Gr S – ½ in Commercial Plant Mix-PG ##-## ¹ 3/8" Grade S – PG ##-##
	PMS thickness ≥0.30'	¾" Grade S Volumetric ² Commercial Plant Mix-PG ##-## ²
Overlay or Minor Rehab	PMS thickness ≥0.15'	Plant Mix Surf Gr S – ¾ in ² Commercial Plant Mix-PG ##-## ²
	0.15' > PMS thickness ≥ 0.10'	Plant Mix Surf Gr S – ½ in Commercial Plant Mix-PG ##-## ¹ Plant Mix Surf Gr S – 3/8 in 3/8" Grade S – PG ##-##
	PMS thickness < 0.10'	Plant Mix Surf Gr S – 3/8 in 3/8" Grade S – PG ##-##

¹ When specifying Commercial Plant Mix and ½" Grade S is desired, change Grade S specification language so that it only allows ½" PMS aggregate.

² If consideration is being given to using 3/8" mix, it is generally more cost effective to use ¾" Grade S in the lower lift(s). 3/8" Grade S is structurally equivalent to ¾" Grade S, but is more expensive due to the higher oil content.

3.1.2 Reclaimed Asphalt Pavement

It is recommended to include recycled asphalt pavement (RAP) within PMS when it is cost effective and/or to reduce the amount of millings wasted. PMS with RAP is typically less expensive than virgin PMS.

MDT has shifted to allowing RAP to be incorporated into surfacing layers, while not mandating its use. MDT now allows RAP in plant mix via percentage of binder replacement rather than percentage by weight of total mix. Currently a special provision provides for an incentive to the contractor to include RAP in the plant mix. Section 401.02.5 Recycled Asphalt Pavement (RAP) provides limits on the inclusion of recycled materials in to hot mix.

RAP refers to asphalt millings produced during cold milling operations. One use for RAP is to include it in new PMS, where the RAP is mixed into the PMS within the hot plant. During this process, the asphalt cement within the RAP is heated and blended with the virgin binder. This lowers virgin binder content between 0.2% to 1.6% when using 10 to 25% RAP, respectively. Binder replacement is highly dependent on the aggregate properties, RAP quality and number of chip seals, etc.

When specified by total weight of plant mix, the amount of RAP incorporated in to Grade S mixes should be limited to 15% within the top lift and 30% within the bottom lifts. These limits are in place because oxidized and age hardened RAP tends to stiffen mixes which leads to premature cracking. The Asphalt Institute has recommendations for specifying binder grade based on the percentage of

RAP/percent binder replacement. For 25% RAP, grade bumping binder is generally not necessary.

It is still possible to mandate RAP in the hot mix. A standard special provision and appropriate bid items must be included to do so. The benefit of specifying RAP is that the binder grades can be adjusted or “bumped” to reduce the overall stiffness of the mix. The following guidelines are used when specifying RAP:

- Past specifications allowed up to 15% RAP (by weight of RAP, not binder) on all mixes, leaving it up to the contractor to use up to 15% RAP if they decide to do so on any lift within the PMS layer. Past specifications allowed up to 25% RAP by weight of RAP in lower lifts.
- If the designer wants to dictate the use of RAP on a project use the bid item “Plant Mix Bit Surf Gr S - ## RAP,” where ## can be 3/8 in., 1/2 in. or 3/4 in. The amount of RAP to be used in the PMS is specified within the special provision.
- See the Performance Grade (PG) binder section below and Asphalt Content section for more information on specifying RAP.

On reconstruction projects, RAP may be used in other ways such as:

- Cold central plant recycling
- Traffic gravel
- Supplement to base gravel (needs to be mixed with crushed aggregate course)
- Digout backfill
- Shoulder gravel
- Guardrail widening
- Detour surfacing

A design memorandum prioritizes the use of RAP on highway projects and should be reviewed when coordinating its use. There are some environmental restrictions placed on the storage and use of RAP. In the past, the Department of Natural Resources (DNRC) has issued memorandums which should be reviewed. Contact the Environmental Services Bureau for updated guidance.

3.1.3 Performance Grade (PG) Binder

Performance Grade (PG) Binder refers to the type of asphalt cement used within the PMS mixture. Asphalt cements are specified by PG grade, for example “PG 70-28.” The numbers, 70 and -28, refer to the pavement temperatures in °C where the asphalt cement should perform well. For example, a PG 70-28 binder should be expected to be rut resistant at pavement temperatures up to 70 °C, and be crack resistant down to negative 28 °C.

MDT uses LTPPBind software with the LTPP high- and low-temperature models for selecting the basic binder grade. The high-temperature reliability target should always be 90% or greater. Low-temperature reliability differs based on whether or not the project is an overlay. If the project is an overlay, the new overlay will probably exhibit some reflective cracking, and the low-temperature reliability

should not be less than 50%. If the project is not an overlay, the low-temperature reliability should be 90% or greater.

The basic binder grade, selected using LTPPBind, is adjusted for traffic volume and load rate according to Exhibit 3-98, taken from the AASHTO Superpave Volumetric Mix Design specification, to determine the adjusted binder grade. These adjustments affect the high-temperature grade only.

**Exhibit 3-8
Traffic Volumes and Binder
Temperature**

Design ESALs ²		Adjustment to the High-Temperature Grade of the Binder ¹		
		Traffic Load Rate		
Daily	20-year ESALs (million)	Standing ³	Slow ⁴	Standard ⁵
< 41	< 0.3	Note - 6	—	—
41 to <410	0.3 to <3	2	1	—
410 to <1370	3 to <10	2	1	—
1370 to <4100	10 to <30	2	1	Note - 6
≥ 4100	≥ 30	2	1	1

¹Increase the high-temperature grade by the number of grade equivalents indicated (one grade is equivalent to 6°C).

²The anticipated project traffic level expected on the design lane over a 20-year period. Regardless of the actual design life of the roadway, determine the design ESALs for 20 years.

³Standing Traffic—where the average traffic speed is less than 20 km/h.

⁴Slow Traffic—where the average traffic speed ranges from 20 to 70 km/h.

⁵Standard Traffic—where the average traffic speed is greater than 70 km/h.

⁶Consideration should be given to increasing the high-temperature grade by one grade equivalent.

Exhibit 3-9 summarizes binder grade and relative cost.

**Exhibit 3-9
Binder Grade and
Relative Cost**

Binder Grade	Approximate Relative Cost
PG 70-28	1.05
PG 64-28	1
PG 58-28	0.75

Often, we will want to ensure that we are specifying a polymer-modified binder. As a general guide, if the range between the high and low temperature grade is more than 90 degrees, polymer modification will be necessary to meet

specification. For example, the range for a PG 64-28 is $64 + 28 = 92$. This will be polymer modified.

MDT typically uses the PG binder grades shown in Exhibit 3-109. The relative cost information is approximate and should be used as a general guide only.

Consideration should be given to using a lesser grade of PG binder in lower lifts when 0.4 ft (120 mm) or more new PMS is required. This decision should be based on the models within the LTPPBIND software as well as discussion with District design and construction staff regarding the project sequencing and whether or not an actual savings will be realized.

Exhibit 3-10 shows binder types readily available in Montana. Binder grades not shown in the Exhibit 3-10 may be difficult to procure and are not recommended. Exhibit 3-10 establishes a recommended binder grade based on traffic loading. Additional guidance on PG binder types is provided after Exhibit 3-10 and should be considered for the design.

Design Parameter	Binder Type
Interstate Roadway, Rest Areas and Scale Sites, or Daily ESAL ≥ 400	PG 70-28
Roadway on National Highway System or daily ESALs ≥ 50 or AADT ≥ 1200	PG 64-28
All other roadways	PG 58-28

**Exhibit 3-10
PG Binder Selection
(Traffic)**

The following are situations in which the **binder grade may be bumped up** from PG 58-28 to PG 64-28 or from PG 64-28 to PG 70-28:

- Construction/Reconstruction projects – Often it is desirable to use polymer modified binders for these projects. PG 64-28 and 70-28 are typically polymer modified.
- Urban routes with stop-and-go traffic and/or high traffic volumes.
- Any route where reoccurring rutting is observed

Consideration should be given to using a lesser PG binder grade in lower lifts when 0.4 ft. or more new PMS is required. As a general rule, binder grade can be dropped one grade within PMS located more than 0.2 ft. below the pavement surface.

In the future, it may be beneficial to look at grade bumping binder when it is determined that higher amounts of RAP (~25% by weight of mix) will be used by a contractor in the plant mix. Downgrading the binder will result in cost savings. Currently, the inclusion of RAP is optional, and grade bumping would have to be executed by change order or by a contractor's VE proposal. This decision should be based on binder grading. Currently, this is not practical in MDT contracts but should be considered in the future.

Consideration can be given to reducing the PG binder grade to a non-polymer modified binder on low volume roads. This accounts for the stiffening effect caused by the oxidized binder within the RAP.

3.1.4 Asphalt Content Selection

The asphalt cement content, (also called AC content or “percent asphalt”) refers to the amount of asphalt cement within the PMS mixture. Asphalt cement contents for ¾ in. mix typically range from 4.5 to 6.5% and are measured as a percentage of the total asphalt mixture by weight. Typically, PMS with larger aggregate have lower asphalt quantities than small aggregate. On average ¾ in. Grade S has 5.4% asphalt, while 3/8 in. Grade S has about 6.2% asphalt. Exhibit 3-11 provides guidance for asphalt content selection.

**Exhibit 3-11
Asphalt Content Selection**

PMS Type	Asphalt Content			
	Commercial PMS ¹	½” Grade S	¾” Grade S	
5.8%		5.4%		
3/8” Grade S – PG ##-##	6.2%			
Plant Mix Surf Gr S – ## in	Estimate asphalt content for each individual project. To assist in the selection, a state map showing as-produced asphalt contents from previous construction projects can be found at the following websites: <p style="text-align: center;"> MDT Map Gallery Montana GIS Map </p> Other methods to estimate asphalt content are to speak with District construction/materials personnel or to utilize the QA Suite software.			
Plant Mix Bit Surf Gr S - ## RAP ²	10% RAP	25% RAP	40% RAP	
	Subtract 0.4%	Subtract 0.9%	Subtract 1.8%	

¹ Include all 3 asphalt contents within Basis of Plan Quantities.

² Estimate a project specific asphalt content in accordance with the method above. Subtract the value given unless project specific information is available for the oil content for the RAP that would dictate otherwise.

A few points to consider when utilizing the Project Specific Asphalt Map:

- In 2004, MDT began using the Hamburg rut test. The test typically reduced asphalt contents by about 0.3%. As a result, subtract 0.3% for projects built in 2004 or earlier to estimate today’s asphalt contents.
- Beginning in 2013, mix design gyrations on high traffic roads (>401 daily ESALs) were lowered to increase asphalt content. This has resulted in an 0.2% increase in asphalt content. As a result, add 0.2% asphalt content to

estimate today's asphalt contents (in addition to the guidance given in the bullet above).

- There are relatively few ½ in. Grade S projects on the map. ½ in. Grade S asphalt contents can be estimated based on ¾ in. Grade S asphalt contents. Do this by adding 0.4% to ¾ in. Grade S projects. For example, if a project on the map indicates that a ¾ in. Grade S project has 5.4% asphalt, assume that the same project would have 5.8% asphalt if it had been ½ in. Grade S.

3.1.5 Pavement Base Course

MDT primarily uses 2 types of base course: untreated crushed aggregate course (CAC) and Cement Treated Base (CTB).

3.5 CRUSHED AGGREGATE COURSE

MDT's most common pavement type is PMS under laid with aggregate base. Aggregate Base Course is now referred to as crushed aggregate course (CAC). The current CAC specification allows the contractor to choose between Crushed Base Course Grade 5A (2 in.-) and Grade 6A (1.5 in.-), and also allows the contractor to choose whether to use crushed top surfacing grade 2A (¾ in. -) within the top 0.15 ft. of CAC.

MDT minimum CAC thickness is 0.65 ft.; this depth includes crushed top surfacing.

In recent years, recycling RAP into virgin CAC has become more common, even on reconstruction projects. This is a cost effective way to reuse RAP and results in a competent base course, provided that it is manufactured as follows:

- It is important to have a uniform blend of CAC and RAP within the pulverized mixture. To achieve a uniform blend, the material can be mixed in either a pugmill (off-site) or with a pulverizer (in-place). Blade mixing is not allowed.
- Within the blend, pulverized PMS should comprise a maximum 50% of the pulverized mixture. Because of variability in existing surfacing thickness, some portions of the project may have a higher percentage. MDT research has shown that the mixture strength decreases when RAP comprised more than 60% of the mixture (Mokwa, 2005).
- Compacted pulverized material can swell up to 12.5% by volume.

3.6 CEMENT TREATED BASE

MDT often uses Cement Treated Base Course (CTB) where it is cost effective. CTB courses are generally 2/3 of the thickness of comparable CAC courses. CTB is often used in areas without economical access to gravel and/or where a thinner overall pavement section is desirable. The CTB aggregate requires a smaller nominal maximum size (1 in.) than CAC aggregate (1 ½ in.).

For reconstruction or new construction projects, the minimum CTB thickness is 0.65 ft.

CTB can be manufactured with a pugmill (off-site) or with a pulverizer (in-place). The ability to manufacture CTB with a pulverizer makes it ideal for full depth reclamation (FDR) of existing pavements.

3.6.1 Pavement Subbase Course

While MDT's most common pavement type is a two-layer pavement, three-layer pavements consisting of a surfacing, base, and subbase layer should also be considered. These pavements tend to be more cost effective on projects with:

- CAC layers in two-layer pavements that are greater than ~12 in. thick.
- Subgrades with soft stiffness ($< 4,000$ psi) and traffic greater than 50 daily ESALs.
- Subgrades with medium ($9,000 \text{ psi} > M_R > 4,000 \text{ psi}$) stiffness, and traffic greater than 800 daily ESALs.

Subbase should consist of material meeting the following requirements:

- 3 in. maximum aggregate size,
- Less than 15% passing the No. 200 sieve; and
- Material passing the No. 40 sieve must have a maximum liquid limit and plasticity index of 30 and 6, respectively.

Subbase material meeting these material requirements can be assumed to have a resilient modulus (M_R) = 12,000 psi and structural coefficient of 0.07. Higher structural coefficients can be utilized if appropriate testing data is approved by MDT. In locations where material meeting the specifications above is unavailable, other granular materials can be used as subbase material. An example of this sort of material is the sand deposits in eastern Montana. The structural coefficient for these materials will usually range from 0.07 – 0.08/in.

In addition, the guidance below should be used when specifying subbase:

- Adequate base course thickness is needed to “protect” subbase materials from high stresses and strains. The layered analysis approach (Figure 3.2, 1993 Guide) is recommended for determining base course thickness in three-layer pavements.
- Subbase material should daylight out into the pavement inslopes, similar to special borrow.
- The frequency of quality control/quality assurance (QC/QA) testing should be similar to base course material. Special borrow QC/QA should not be used for subbase material.
- Minimum subbase thickness is 0.65 ft.

3.7 TYPICAL SECTIONS UTILIZING GEOSYNTHETICS

MDT normally specifies geosynthetics for the following reasons:

- Separation and stabilization of known or suspected problem areas on a project. In these situations, geotextiles are used as a separation layer between special borrow and the existing ground for constructability reasons, not to reduce the thickness of the typical section.

In locations where material meeting the specifications above is unavailable, other granular materials can be used as subbase material.

- Separation between the subgrade and gravel surfacing section. In these situations, geotextiles are used as a separation layer to prevent the contamination and long-term weakening of the surfacing section through the migration of fines from the subgrade.
- Base course reduction through the use of geogrids and/or geosynthetics. MDT is conducting ongoing research to determine whether or not the thickness of the typical section can be reduced by using geosynthetics. Reports may be found at the following website:

[MDT Geosynthetic Research Report](#)

If base course reduction through the use of geogrids or geosynthetics is planned for a project, it must be planned and monitored as an experimental project. Contact Surfacing Design for information on design methods.

3.8 RIGID PAVEMENT MATERIAL SPECIFICATIONS

Concrete pavement material specifications are located in Section 501 of the standard specification.

3.9 REFERENCES

1. AASHTO. *Guide for Design of Pavement Structures*. AASHTO, Washington D.C., 1993.

MONTANA DEPARTMENT OF TRANSPORTATION

Pavement Design Manual

Chapter 4

Flexible Pavement Design Overview

November 2018



CHAPTER 4 FLEXIBLE PAVEMENT DESIGN OVERVIEW.4-1

4.1 Introduction.....	4-1
4.2 Designing with Thick PMS Layer.....	4-2
4.3 Pavement Failure Types	4-2
4.4 Pavement Overlays – Staged Construction.....	4-3
4.5 References.....	4-3



Chapter 4

Flexible Pavement Design Overview

4.1 INTRODUCTION

Effective pavement design is an important element of the overall roadway project design. The pavement is the portion of the highway most obvious to the motorist. From a project design perspective, pavement and related items comprise from 10 percent to 90 percent of highway construction costs. Because of this, the designer should not under design pavements, as it may lead to:

- Increased user costs (fuel consumption, tires, repair, etc.),
- Increased accident cost,
- Increased maintenance costs,
- Costs of user delays due to reconstruction and maintenance, and
- Cost of early reconstruction.

Pavement design is both art and science. Precise pavement design and performance prediction are somewhere between difficult and impossible. The difficulty is due to a number of variables that are challenging to predict, including:

- Pavement material properties that change due to climate and over time,
- Truck traffic prediction over the 20-year design life,
- Construction and maintenance practices, and
- Subgrade soil properties.

Pavement design should be conservative, since the above variables are difficult to predict, but not overly conservative. The cost of overdesign can be substantial due to the high costs of pavement materials and the costs of overdesign could be better used on another pavement.

It is believed that MDT's pavement design method has a practical amount of conservativeness balanced with cost-effectiveness. It has been adjusted over the years to reflect the improvements made in construction practices, materials, and traffic predictions. However, some level of conservativeness is still used in those items that continue to be hard to predict, such as the subgrade soil quality.

4.2 DESIGNING WITH THICK PMS LAYER

Ideally, flexible pavement designs incorporate a relatively thick PMS layer. This reduces the critical tensile stress at the bottom of the PMS layer. This can occur during initial construction or through future pavement preservation projects which incorporate overlays. Whenever possible, surfacing designers should recommend overlays rather than mill/overlay projects. This will bolster the pavement structure and reduce stresses on the aging plant mix layers that are lower in the pavement section.

Thicker PMS layers place the critical tensile stress deeper in the pavement, reducing its magnitude. Thin PMS layers place the stress higher in the pavement, increasing its magnitude and possibly causing a tensile crack. This is shown in Exhibit 4-1 below.

Exhibit 4-1
PMS Thickness's Effect
on Critical Tensile
Strain

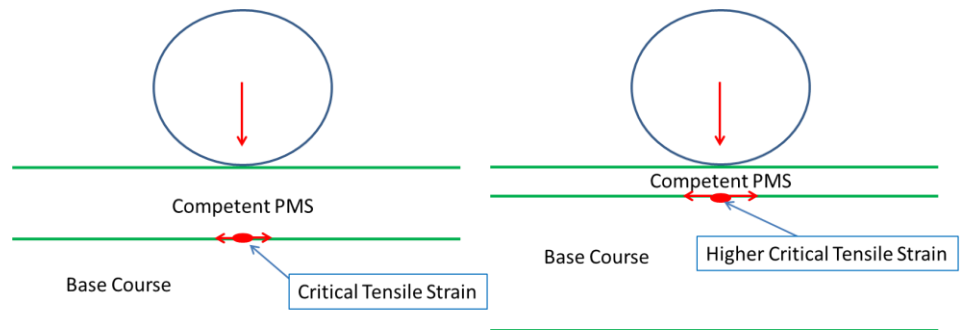

4.3 PAVEMENT FAILURE TYPES

Most of Montana's hard surfaced pavements are flexible pavements surfaced with PMS. Generally, flexible pavements fail in the following ways:

- **Subgrade Rutting.** Pavements that are too thin do not adequately dissipate tire contact pressures, resulting in high stresses within the pavement subgrade. This stress can result in further consolidation or shoving of subgrade materials, or cause subgrade fines to pump up and into the base course. This problem will result in deep, wide pavement rutting and failure.

In general, MDT's pavements rarely fail due to subgrade rutting. It is thought that MDT's pavement design and pavement preservation overlay program result in thick pavements that dissipate pavement stresses to levels that do not cause subgrade damage.

- **Alligator Cracking.** Vehicle loadings cause pavement surface deflection that result in horizontal stresses on the bottom of the PMS layer. These horizontal stresses may exceed the PMS tensile strength, resulting in

tensile cracks propagating upwards toward the pavement surface. These cracks will manifest themselves as alligator cracking within the wheel paths.

Alligator cracking often causes MDT's pavements to fail. **The most effective way to mitigate alligator cracking is to design pavements with adequate surfacing thickness.** This is accomplished by using relatively thick surfacing sections.

- **Low Quality Pavement Materials.** These are pavement failures caused by low quality pavement materials. Some examples of this are PMS rutting, stripping, and raveling. These pavement distresses can cause pavements to fail even if the pavement is structurally adequate.

Unfortunately, these problems are often unforeseeable and can be the result of poor construction processes. The designer can reduce the failures by specifying the correct pavement materials as discussed in this manual.

4.4 PAVEMENT OVERLAYS – STAGED CONSTRUCTION

PMS overlays can be used to build thick pavements resistant to alligator cracking. Generally, an overlay will increase a 20-year pavement design to a 30-year pavement design if the overlay is placed before alligator cracking occurs. A second overlay may result in a pavement that will not alligator crack, often referred to as a “perpetual pavement” by the asphalt industry.

An example of pavements that have become alligator crack resistant through overlays is MDT's Interstate system. Most of the Interstate was originally built in the 1960s and 1970s with 0.35 ft. PMS. Throughout the years, these pavements have been overlaid multiple times, and most of them are still in service. Currently, many of these pavements are periodically milled and filled to address rutting or smoothness, but alligator cracking is minimal.

The following guidance will allow the buildup of surfacing thickness through overlays:

- Roads should be constructed with enough pavement width to place at least one overlay upon them.
- Overlays should be placed before alligator cracking occurs. PMS overlays placed on alligator cracked pavement may experience reflective cracking. This may result in alligator cracking of the PMS overlay in a relatively short time period.

4.5 REFERENCES

No references were identified for this chapter.

The most effective way to mitigate alligator cracking is to design pavements with adequate surfacing thickness.

MONTANA DEPARTMENT OF TRANSPORTATION

Pavement Design Manual

Chapter 5

Flexible Pavement Design Method

November 2018



Contents

CHAPTER 5 FLEXIBLE PAVEMENT DESIGN METHOD 5-1

5.1 Introduction	5-1
5.2 1993 AASHTO Flexible Pavement Design	5-1
5.2.1 Layered Design Analysis Overview	5-2
5.2.2 Nomograph	5-2
5.2.3 Low Volume Roads Flexible Pavement Design	5-3
5.3 Minimum Pavement Layer Thicknesses	5-4
5.4 Pavement Layer Structural Coefficients	5-5
5.5 Flexible Pavement Design Input Parameters	5-6
5.5.1 Traffic (W18, ESALS).....	5-6
5.5.2 Initial and Terminal Serviceability	5-7
5.5.3 Reliability Level and Standard Deviation	5-8
5.5.4 Drainage Coefficients.....	5-8
5.5.5 Number of Construction Stages	5-8
5.5.6 One Direction Width.....	5-9
5.5.7 Subgrade Resilient Modulus.....	5-9
5.6 Flexible Pavement Design Steps	5-20
5.7 References	5-24



Chapter 5

Flexible Pavement Design

Method

5.1 INTRODUCTION

MDT pavement design uses the structural number (SN) approach presented in the 1993 AASHTO Guide. The SN is an abstract number that expresses pavement structural strength required for given combinations of soil support (M_R) and total traffic expressed in Equivalent Single Axle Loadings (ESALs). The following chapter provides an overview of the flexible pavement design method.

In addition to the information provided in Chapter 5, Appendix E provides a pavement reconstruction design example using the 1993 AASHTO DARWin 3.1 and Appendix F provides a spreadsheet version of the DARWin 3.1.

5.2 1993 AASHTO FLEXIBLE PAVEMENT DESIGN

The 1993 AASHTO Guide (1993 Guide) and the Pavement Interactive website provide an in-depth overview of the design method. The following empirical equation from the 1993 Guide is used for flexible pavement design ((1), AASHTO, 1993, (2).

$$\log_{10}(W_{18}) = Z_R \times S_o + 9.36 \times \log_{10}(SN+1) - 0.20 + \frac{\log_{10}\left(\frac{\Delta PSI}{4.2-1.5}\right)}{0.40 + \frac{1094}{(SN+1)^{5.19}}} + 2.32 \times \log_{10}(M_R) - 8.07$$

Where:

W_{18} = predicted number of 80 kN (18,000 lb.) ESALs

Z_R = standard normal deviate

S_o = combined standard error of the traffic prediction and performance prediction

SN = Structural Number (an index that is indicative of the total pavement thickness required)

= $a_1D_1 + a_2D_2m_2 + a_3D_3m_3 + \dots$ a_i = i^{th} layer coefficient D_i = i^{th} layer thickness (inches) m_i = i^{th} layer drainage coefficient

ΔPSI = difference between the initial design serviceability index, p_o , and the design terminal serviceability index, p_t

M_R = subgrade resilient modulus (psi)

5.2.1 Layered Design Analysis Overview

In the 1993 Guide, Section 3.1.5 describes the layered design analysis. The layered design analysis is a procedure used to determine the minimum pavement layer thicknesses needed to “protect” the pavement layers below it. For example, for an Interstate pavement the layered design analysis may show that the PMS layer must be at least 0.5 ft. thick to “protect” the underlying base layer.

The layered design analysis is a very important procedure used to calculate minimum PMS layer thicknesses, since PMS layers may crack prematurely if they are too thin. However, the designer does not have to conduct a layered design analysis. Instead, utilize the minimum PMS, CAC, CTB, and subbase layer thicknesses shown in Exhibit 5-4, which were calculated based on layered design analysis.

The designer should design multiple pavement sections for each project. For example, when designing a high-volume, thick pavement section the designer may choose to design all three pavement types (two layer, three layer, and special borrow) and provide all designs to the project manager. The project manager can compare all designs while designing the road alignment and grade to determine which option is the most cost effective.

5.2.2 Nomograph

Flexible pavement design can be solved using the nomograph provided in the 1993 Guide ((1), 1993, AASHTO, pg. II-32).

5.2.3 Low Volume Roads Flexible Pavement Design

Low volume roads are defined as those having 137 or fewer daily ESALs during the 20-year pavement design period. The 1993 Guide (Chapter 4, Low Volume Design) should only be used for Secondaries or when a reliability of 75% is deemed appropriate.

The “standard” pavement design method described in the 1993 Guide tends to be overly conservative when designing low-volume pavements, especially on poor subgrade soils. Part II, Chapter 4 of the 1993 Guide page II-77 through II-81 presents an alternative method of designing low volume pavements that is less conservative. ((1), AASHTO, 1993)

Low volume pavement design and rehabilitation are designed similarly to regular pavement designs, except that SN_{Des} is calculated differently, as summarized in the rest of this section.

Calculating low-volume road SN_{Des} is relatively simple, requiring only the daily ESALs over the design life (typically a 20-year period) and the subgrade soil quality. The designer should use Exhibits 5-1, 5-2, and 5-3 to calculate SN_{Des} based upon the traffic and subgrade quality.

Category	Traffic Level – Daily ESALs ¹
High	96-137
Medium	55-82
Low	7-41

¹ Based on 20-year Design Life. Since Montana is in Region VI, use VI for design.

US Climatic Region	Relative Quality of Roadbed Soil				
	Very Poor	Poor	Fair	Good	Very Good
I	2,800	3,700	5,000	6,800	9,500
II	2,700	3,400	4,500	5,500	7,300
III	2,700	3,000	4,000	4,400	5,700
IV	3,200	4,100	5,600	7,900	11,700
V	3,100	3,700	5,000	6,000	8,200
VI	2,800	3,100	4,100	4,500	5,700

Exhibit 5-1
Traffic Level Categories for
Low Volume Roads Pavement
Design (AASHTO 4.2.1)
((1), AASHTO, 1993)

Exhibit 5-2
Subgrade Characterization M_R
(PSI) for Low Volume Roads
Pavement Design (AASHTO
4.3)
((1), AASHTO, 1993)

Exhibit 5-3
Low Volume Pavement Design
SN (AASHTO 4.7)
((1), AASHTO, 1993)

Relative Quality of Roadbed Soil	Traffic Level	US Climatic Region					
		I	II	III	IV	V	VI
Very Good	High	2.6-2.7	2.8-2.9	3.0-3.2	2.4-2.5	2.7-2.8	3.0-3.2
	Medium	2.3-2.5	2.5-2.7	2.7-3.0	2.1-2.3	2.4-2.6	2.7-3.0
	Low	1.6-2.1	1.8-2.3	2.0-2.6	1.5-2.0	1.7-2.2	2.0-2.6
Good	High	2.9-3.0	3.0-3.2	3.3-3.4	2.7-2.8	3.0-3.1	3.3-3.4
	Medium	2.6-2.8	2.7-3.0	3.0-3.2	2.4-2.6	2.6-2.9	2.9-3.2
	Low	1.9-2.4	2.0-2.6	2.2-2.8	1.8-2.3	2.0-2.5	2.2-2.8
Fair	High	3.2-3.3	3.3-3.4	3.4-3.5	3.0-3.2	3.2-3.3	3.4-3.5
	Medium	2.8-3.1	2.9-3.2	2.7-3.3	2.7-3.0	2.8-3.1	3.0-3.3
	Low	2.1-2.7	2.2-2.8	2.3-2.9	2.0-2.6	2.1-2.7	2.3-2.9
Poor	High	3.5-3.6	3.6-3.7	3.7-3.9	3.4-3.5	3.5-3.6	3.7-3.8
	Medium	3.1-3.4	3.2-3.5	3.4-3.6	3.0-3.3	3.1-3.4	3.3-3.6
	Low	2.4-3.0	2.4-3.0	2.5-3.2	2.3-2.8	2.3-2.9	2.5-3.2
Very Poor	High	3.8-3.9	3.8-4.0	3.8-4.0	3.6-3.8	3.7-3.8	3.8-4.0
	Medium	3.4-3.7	3.5-3.8	3.5-3.7	3.3-3.6	3.3-3.6	3.4-3.7
	Low	2.6-3.2	2.5-3.3	2.6-3.3	2.5-3.1	2.5-3.1	2.6-3.3

5.3 MINIMUM PAVEMENT LAYER THICKNESSES

The recommended PMS, base, subbase, and special borrow thicknesses are shown in Exhibit 5-4. Plant mix thickness is based on daily ESALs during a 20-year pavement design life.

Exhibit 5-4
Pavement Layer Thickness

PMS		Base Course / Subbase / Special Borrow	
ESALs (Daily)	PMS Thickness ¹	Material	Thickness
>2000	0.70'	Crushed Aggregate Course (CAC)	0.65' min.
1000 – 2000	0.60' – 0.70'	Cement Treated Base (CTB)	0.65' min.
501 - 1000	0.50 – 0.60'	CAC/CTB pulverized in place	0.50' min.
201 - 500	0.40 - 0.50'	Subbase Course	0.65' min
101 – 200	0.30 – 0.40'	Special Borrow	2.0'
0 - 100	0.30' ¹		

¹In certain cases 0.25' of PMS can be used for ½" or 3/8" mix, when budgets are constrained.

Exhibit 5-5 provides pavement layer thickness for other types of situations.

Other Situations	
Urban Curb & Gutter Crossovers Rest Areas	0.40' min.
Mainline Interstate Pavements	0.50' min.
Non-Mainline Interstate Pavement including Interchanges	0.4' min.
Approaches	0.2' min.
Bike Path	0.2' min.

**Exhibit 5-5
Pavement Layer Thickness for
Other Situations**

5.4 PAVEMENT LAYER STRUCTURAL COEFFICIENTS

For new or reconstructed pavements, Exhibit 5-6 should be used for the structural coefficients. There may be other materials available or recommended for surfacing or base course. It is up to the designer to investigate these products to determine structural coefficients.

**Exhibit 5-6
Structural Coefficients for New
and Reconstructed Pavements**

Virgin Materials	Coefficient per in.	Existing Materials	Coefficient per in.
PMS (All Grades)	0.41	PMS (All Grades) ²	0.20 - 0.33
Crushed Aggregate Course (CAC)	0.14	Crushed Aggregate Course (CAC)	0.12
PMS / CAC Mixture (pulverized, pugmilled, or mixed in-place)	0.12	PMS / CAC Mixture (pulverized, pugmilled, or mixed in-place)	0.12
Cement Treated Base (CTB)	0.20	Cement Treated Base (CTB)	0.18 #
CTB Pulverized	0.16	CTB Pulverized	0.14 #
Cold Recycled Asphalt (CIR)/(CCPR)	0.30	Cold Recycled Asphalt (CIR)/(CCPR)	0.20
Subbase Material ¹	0.07 - 0.10	Special Borrow	0.07

¹ Structural Coefficients for subbase of lesser quality should be reduced as determined by the designer.

When less than 2 feet of special borrow is specified, it should be treated as sub-base by assigning it a structural number and including it in the pavement structure.

² Coefficient for existing PMS should be reduced based on stripping analysis.

Higher values may be applied based on unconfined core test results.

5.5 FLEXIBLE PAVEMENT DESIGN INPUT PARAMETERS

Several input parameters are required to solve the 1993 AASHTO design equation. Traffic (18-kip equivalent single axle loadings, referred to as W18, ESALs) and subgrade resilient modulus (M_R) are probably the two most critical inputs influencing layer design thickness. These two inputs can also be the most difficult to predict. Traffic is described below, while subgrade resilient modulus is described at the end of this section. The remaining input parameters primarily deal with statistical concepts.

5.5.1 Traffic (W18, ESALS)

Highway traffic is a combination of many vehicle types, all having different gross weights and axle configurations. To simplify the variety of loadings for pavement design, vehicle loadings are converted to 18-kip ESAL. The process of collecting traffic data and converting it to ESALs is complex, and the 1993 Guide presents this in more detail.

It is important to accurately characterize traffic loading for pavement design. Small errors carried through the project design life can produce unexpected results, such as underdesign and premature failure or overdesign and unnecessary expense.

For pavement design, traffic information is provided by the Traffic Data Unit within the Planning Division. Traffic information is usually requested by the road design project manager after the preliminary field review, and the pavement designer is copied on this traffic information. The pavement designer can also contact the Traffic Data Unit directly to request traffic information. A sample copy of a traffic report is included in Appendix A.

Annual traffic counts are available on an interactive map provided at the following MDT website:

[MDT Interactive Maps](#)

Flexible pavement design life is 20 years unless specified otherwise by the District. 20-year traffic information is provided by the Traffic Data Unit by default. For designs with other than 20-year design lives, a note should be placed in the project file explaining why another design life length was used.

The design input for pavement design is the total ESALs during the pavement design life. An example of how to calculate this is shown in Exhibit 5-7.

Example Problem: Calculating Design Life ESAL Loading
The traffic memorandum in Appendix A states that the ESAL = 23. The ESAL is the average daily ESAL loading during the 20-year design life. In this case, the total ESALs during the 20-year design life is calculated as follows:
$\begin{aligned} \text{Design Life ESALs} &= \text{Daily ESALs} \times \text{Design Life (years)} \times 365 \text{ days per year} \\ &= 23 \text{ ESALs per day} \times 20 \text{ years} \times 365 \text{ days per year} \\ &= 167,900 \text{ ESALs over the 20 year design life} \end{aligned}$

**Exhibit 5-7
Example Problem for
Calculating Design Life ESAL
Loading**

5.5.2 Initial and Terminal Serviceability

Pavement serviceability is defined as the pavement's ability to serve the vehicles using the roadway. Serviceability is measured using the Present Serviceability Index (PSI), which ranges from 0 (impassible road) to 5 (perfect road). Initial serviceability is the PSI immediately after a road is reconstructed or rehabilitated, while the terminal serviceability is the PSI where road rehabilitation, resurfacing, or reconstruction becomes necessary. For pavement design, use 4.2 and 2.5 for initial and terminal serviceability, respectively.

PSI is a subjective rating based upon driver's opinion of road conditions. In more recent years, International Roughness Index (IRI) has been used more than PSI to measure road serviceability. IRI is used by the Construction Division for specifying pavement smoothness. PSI of 4.2 and 2.5 correspond to an IRI equal to about 45 and 185 in/mile respectively. Exhibit 5-8 shows a common correlation between PSI and IRI.

Exhibit 5-8
PSI vs. IRI Correlation (3)

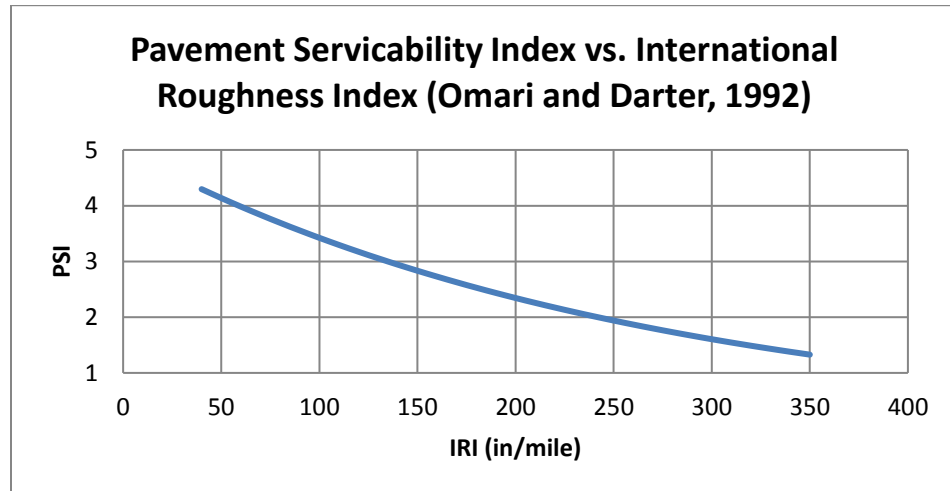

Source: Omari and Darter, 1992 (3)

5.5.3 Reliability Level and Standard Deviation

The reliability level is a means of incorporating some degree of certainty into the design process to ensure that a pavement will last through the design life. The reliability factor accounts for variations in both traffic and performance prediction. The following guidance should be used for designating reliability levels:

- Interstate and National Highway System (NHS): 85-95% (typically 90%)
- Primary Highways: 80-90% (typically 85%)
- Secondary, Urban and X-Routes: 70-85% (typically 75%)

Extra consideration should be given for light vehicle traffic (ADT) and truck traffic in urban areas. These locations should be designed with a higher reliability resulting in a more robust section. A less robust section may result in more frequent maintenance requiring detours, reduced speeds and increased stress on the travelling public as well as MDT.

The standard deviation is used as a separate factor from reliability to account for variations in both traffic predictions and pavement performance predictions. This allows the designer to use the most representative mean or average value for all design variables eliminating the need to input “conservative estimates” for design variables. 0.45 should be used for standard deviation.

5.5.4 Drainage Coefficients

The drainage coefficient (m_i) is used to increase or decrease pavement layer structural coefficients (a_i) based on drainage quality. 1.0 should be used as a drainage coefficient for all materials. The 1993 AASHTO recommends using 1.0 for stabilized base due to performance history.

5.5.5 Number of Construction Stages

The number of construction stages is required when using the DARWin software. One construction stage should be assumed for all projects.

5.5.6 One Direction Width

The directional width is required when using the DARWin software. 12 ft. should be assumed for all designs.

5.5.7 Subgrade Resilient Modulus

Resilient Modulus (M_R) is a fundamental material property used to characterize unbound pavement materials. It is a measure of material stiffness and provides a means to analyze stiffness under different conditions, such as moisture, density and stress level. In the laboratory, M_R is determined using the triaxial test, which can be found at the following website:

[Triaxial Test](#)

The test applies a repeated axial cyclic stress of fixed magnitude, load duration, and cycle duration to a cylindrical test specimen. While the specimen is subjected to this dynamic cyclic stress, it is also subjected to a static confining stress provided by a triaxial pressure chamber. It is essentially a cyclic version of a triaxial compression test; the cyclic load application is thought to more accurately simulate actual traffic loading. M_R is defined as a ratio of applied axle deviator stress and axial recoverable strain. MDT does not conduct triaxial testing at this time.

Pavement sections are designed based on the subgrade M_R of:

- The top five feet of the subgrade directly beneath the surfacing section in the case of pavements without special borrow, or
- The special borrow with consideration of subgrade stiffness, in the case of pavements under laid with two or more feet of special borrow.

MDT utilizes resistance value (R-Value) testing and FWD back-calculation to estimate M_R as detailed later in this section. MDT uses the lesser value of the 85th percentile R-Value and results of FWD test results during spring thaw conditions.

It should be noted that the R-Value test uses disturbed specimens while FWD measures undisturbed stiffness. Standard Penetration Test (SPT) blow counts can be used to compare M_R values based on R-Value, soils class, and FWD.

M_R varies over the course of a year, lowering and increasing dramatically during the spring thaw (saturation) and winter freeze, respectively. This change is more pronounced in clay and silts and less so with sand and gravels. For example, the M_R of clay can dip as low as 3,000 psi in the spring and up to 20,000 psi in the winter. The exhibit below illustrates this phenomenon. To account for this variation, the 1993 Guide recommends using an average annual M_R .

MDT does not use an average annual M_R . Instead, MDT uses M_R based on spring thaw (worst case) conditions for pavement design. This is a conservative practice but believed to work since it is difficult to determine the subgrade type, compaction, and loading conditions that will occur during construction.

For these reasons, MDT has used the spring thaw M_R for pavement design for a long time, and field performance, including lack of subgrade rutting, has indicated that it is a reasonable practice.

An in-depth study was conducted on the measurement of subgrade soil parameters. Various relationships of soil class, R-Value, CBR, and M_R are evaluated. The study can be found at the following website:

[Study of Measurement of Subgrade Soil Parameters](#)

Subgrade M_R determination for pavement design is discussed in the next two sections. Exhibit 5-9 provides the subgrade modulus variations throughout the year from the 1993 Guide.

Exhibit 5-9
Subgrade Modulus Variations
Throughout the Year (1993
Guide, page I-24)
((1), AASHTO, 1993)

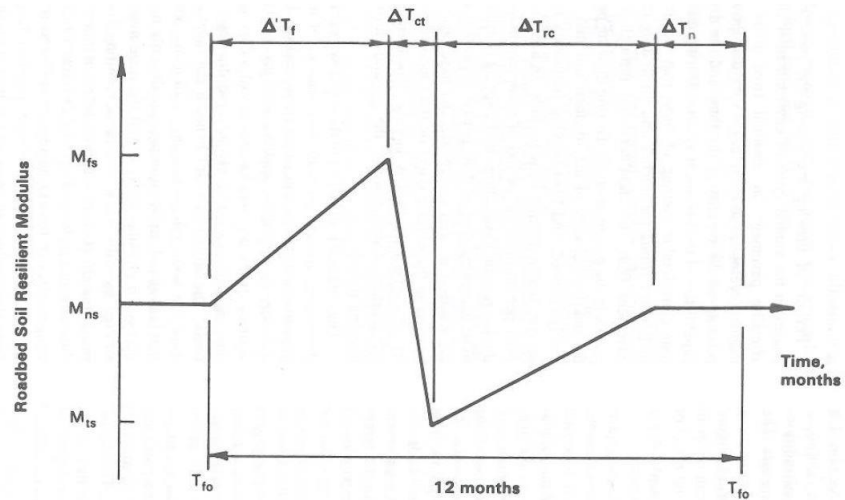

M_{fs} = Frozen roadbed modulus
 M_{ns} = Normal roadbed modulus
 M_{ts} = Thaw (reduced) roadbed modulus = $r_t \times M_{ns}$

r_t = Thaw reduction factor
 T_{fo} = Month freeze started
 ΔT_f = Time of freeze
 ΔT_{ct} = Time of critical thaw
 ΔT_{rc} = Time of thaw recovery
 ΔT_n = Time-normal roadbed condition

Source: From *The Guide for the Design of Pavement Structures*, Copyright 1993, by the American Association of State Highway and Transportation Officials, Washington, DC. Used by permission.

Using R-Value to Estimate $M_{R(Des)}$

R-Value is a laboratory soil test that measures the support capabilities of subgrade soils. The R-Value tests the soil's saturated condition and is considered to be an estimate of subgrade support capabilities during the spring thaw.

This section discusses how to determine the subgrade M_R ($M_{R(Des)}$). The following steps describe this process.

Step 1:

R-Value soil samples are gathered during the District soil survey (EPS Act. 450) and sent to the Headquarters materials laboratory for R-Value testing.

Step 2:

R-Value test results are provided to the Surfacing Design Unit upon the soil survey. The soil survey is provided either via email from the Testing Section's SiteManager software, or via paper copy on materials lab form 111 (Appendix D, Exhibit D-7) entitled "MDT Preconstruction Soil Survey Data and Special Recommendations Relative to Subgrade and Road Surface Design."

Step 3:

In each soil boring location, determine the R-Value of the material within the top two feet of subgrade.

Step 4:

The soil survey should be reviewed to determine major changes in soils and R-Value. For example, it may be clear that for the first three miles of a seven-mile project, soils are fairly uniform, and a particular R-Value will represent the area. However, the remaining four miles may be substantially different, and a different R-Value may have to be used in the design. If this is the case, two typical sections may be recommended. Exhibits 5-10 and 5-11 provide an R85% calculation example.

This page intentionally left blank.

Exhibit 5-10 R85% Calculation Example

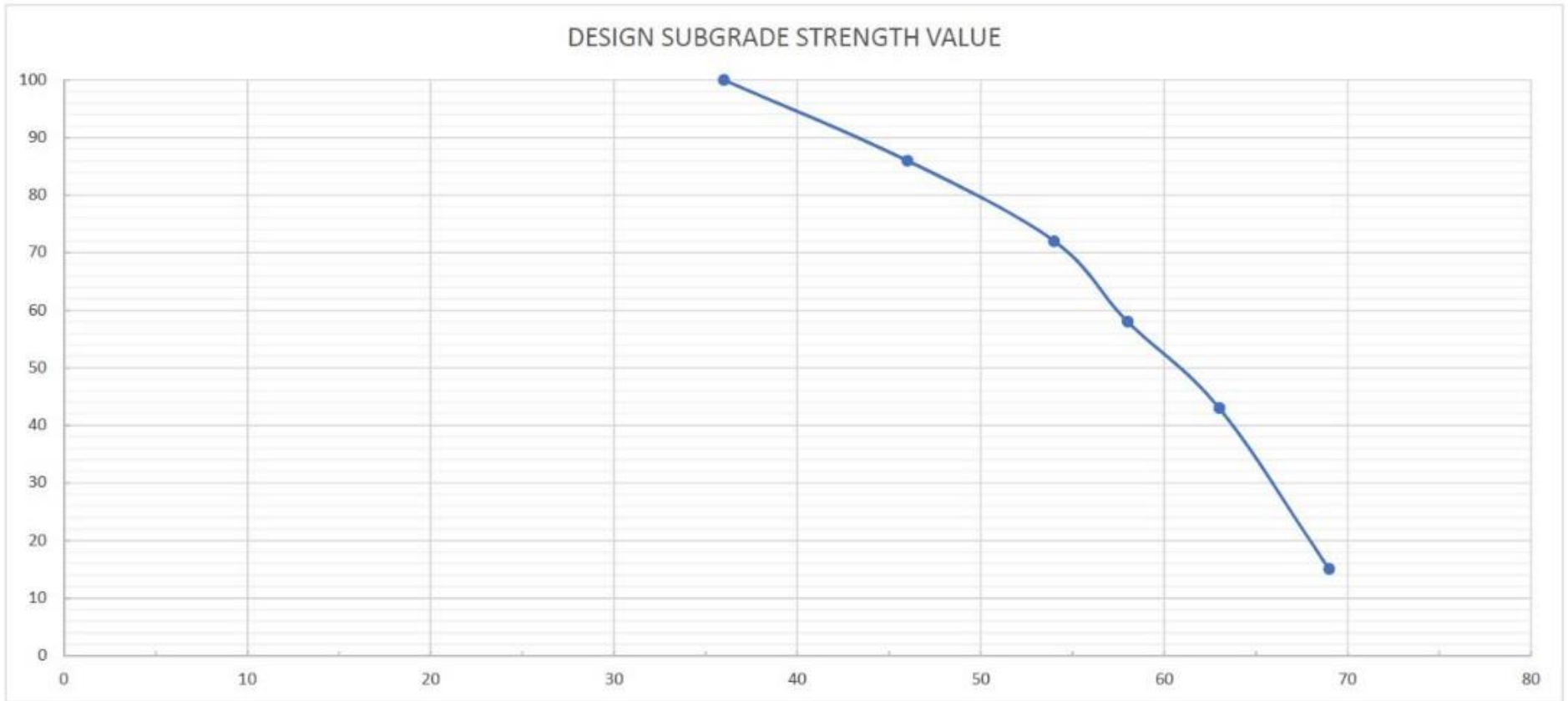

Exhibit 5-11 R85% Calculation Example

R-Value	Number >	%>
36	7	$(7 / 7) \times 100 = 100\%$
46	6	$(6 / 7) \times 100 = 86\%$
54	5	$(5 / 7) \times 100 = 72\%$
58	4	$(4 / 7) \times 100 = 58\%$
63 (2)	3	$(3 / 7) \times 100 = 43\%$
69	1	$(1 / 7) \times 100 = 15\%$

Step 5:

The representative R-Values are plotted on a graph to determine the 85th-Percentile R-Value (R_{85}). Use the following steps along with the Exhibits 5-10 and 5-11 above to determine $R_{85\%}$:

1. List all representative R-Values under the R-Value column, beginning with the lowest.
2. Under the Number => column, list the number of R-Values that are equal to or more than the corresponding R-Value to the left.
3. Each number in the center column is divided by the total number of R-Values and multiplied by 100. These percentages are plotted and connected with a line. Some interpolation may be necessary. A point where this line crosses 85% becomes $R_{85\%}$ that is used to calculate $M_{R(Des)}$.

Step 6:

Calculate $M_{R(Des)}$: The relationship between $R_{85\%}$ and $M_{R(Des)}$ commonly used by MDT is from *NCHRP 2-37A Development of the 2002 Guide for the Design of New and Rehabilitated Pavement Structures (4)*. This relationship is intended for fine grained soils with an R-Value of less than 20:

$$M_{R(Des)} = 1155 + 555 * R_{85th\%}$$

Where:

Minimum $M_{R(Des)} = 3,250$ psi

Maximum $M_{R(Des)} = 19,000$ psi

California Bearing Ratio (CBR) is a soil strength test that is commonly used by MDT consultants. CBR testing can be substituted for R-Value testing. $CBR_{85\%}$ is converted to $R_{85\%}$ as shown below (4).

$$4. 60 * (CBR_{85\%})^{0.64} - 2.08 = R_{85\%}$$

Where:

$CBR_{85\%}$ = The 85th Percentile CBR calculated in the same manner as $R_{85\%}$ (See Steps #1 - #3 above)

A-1-a subgrade materials should be R-Value tested to determine the design R-Value. However, if A-1-a materials are not R-Value tested, they can be assumed to have an R-Value of 30 ($M_R = 12,000$ psi) without testing.

Both A-6 and A-7 subgrade soils are not tested for R-Value. An R-Value of 5 is assumed for these materials. FWD back-calculated should be reviewed to determine M_R , but in the absence of FWD M_R , an M_R of 3,250 psi can be assumed.

M_R Calculated from Falling Weight Deflectometer

MDT's NDT Unit is responsible for conducting FWD and GPR testing. A more thorough summary of this equipment and its use is located in Chapter 16. This section summarizes the use of FWD-generated subgrade M_R for new pavement design.

The NDT unit provides the following FWD testing that can be used to determine subgrade M_R :

- **Network level FWD/GPR** testing is done on all state roadways on a 5-year rotation, at 820 ft. (250 m) increments within the outside wheel path of the driving lane in one direction only. Network level testing may occur during the summer months which can yield a higher M_R than during the period of spring thaw.
- **Project level FWD/GPR:** In addition to Network level testing, project level testing is done prior to road construction projects, at 330 ft. (100 m) increments within the outside wheel path of the driving lane in one direction only. A second run may be completed (one in spring and one in fall) if the schedule of the project allows. GPR testing is done continuously. This testing is done early in the project design process before the Surfacing Design Unit's preliminary surfacing design activity (Activity 600).

Exhibit 5-12 provides an example FWD subgrade M_R printout.

Exhibit 5-12 Example FWD Subgrade Mr Printout

<u>7/18/2013</u>	<u>PMS</u>	<u>BASE</u>	<u>SUB</u>
<i>Average</i>	379626	12991	11303
<i>Std. Dev.</i>	150412	7557	2722
<i>Lab</i>	170832	8055	5652
	6.2"	14.0"	

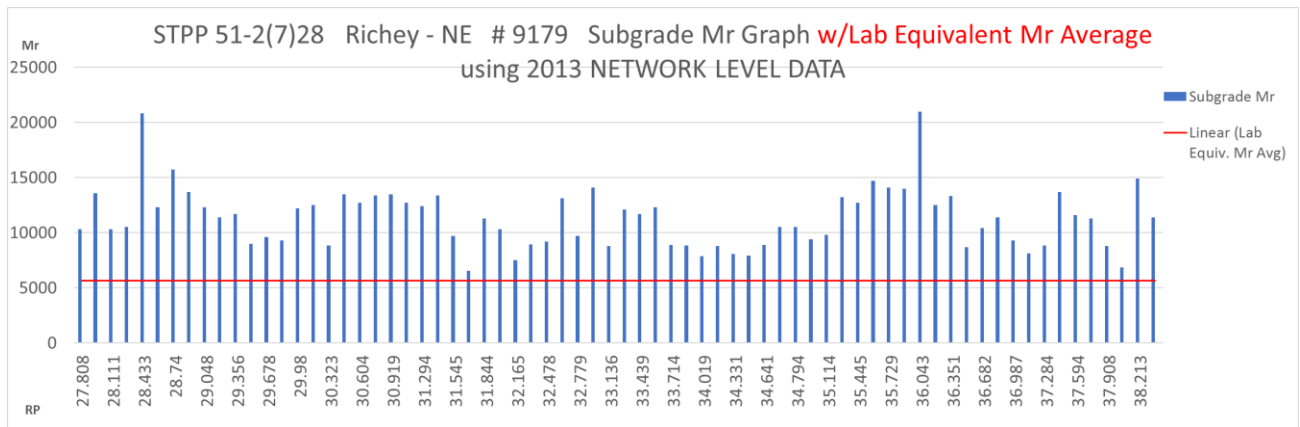

After FWD and GPR data is collected, the NDT unit processes the deflection data and back-calculates the in-situ subgrade M_R . The Surfacing Design Unit receives the data along with an Excel spreadsheet summarizing the subgrade M_R . The exhibit above shows an example of the *unadjusted* back-calculated subgrade M_R . The table below the bar graph shows four different values:

- **Average:** This is the average value of all the unadjusted M_R values.
- **Std. Dev:** The standard deviation of the unadjusted M_R values.
- **Corrected:** Calculated as follows:
 - $\text{Corrected } M_R = \text{Average } M_R - 0.7 * \text{Std. Dev.}$
- **Lab:** This is the laboratory M_R ($M_{R \text{ Lab}}$) converted from the Average M_R calculated as follows:
 - $M_{R \text{ Lab}} = \text{Unadjusted Average } M_R * 0.5$

$M_{R \text{ Lab}}$ should be used for pavement design. The reason for this is that the AASHTO pavement design equation is based upon laboratory calculated Subgrade M_R . The lab resilient modulus for all three layers was derived by multiplying the *average* by a coefficient. These are modified values from the Design Pamphlet for The Backcalculation of Pavement Layer Moduli in Support of The 1993 Aashto Guide for The Design of Pavement Structures (FHWA-RD-97-076 booklet) (5). This booklet shows what coefficients to use to approximate a laboratory resilient modulus value from a back-calculated resilient modulus value. The NDT has been instructed to use a coefficient of 0.45 for PMS, a 0.62 for unbound granular bases, and 0.50 for subgrade.

M_R Estimated for Special Borrow Pavements

There will be instances in which $M_{R(\text{Des})}$ will need to be estimated. This situation will usually occur when designing special borrow pavements. Recall that special borrow pavements are designed based on the special borrow M_R , not the subgrade M_R . In this case, the material to be used for special borrow will be unknown since it will be provided by the Contractor.

In these instances, the designer will often estimate $M_{R(\text{Des})}$ based upon the special borrow material that is locally available, and/or the type of special borrow the designer determines should be used. Most often, pit run A-1-a material is used for special borrow, and a design R-Value of 30 is assumed.

Once the special borrow R-Value is determined/estimated, use the following equation to determine $M_{R(\text{Des})}$ (4).

$$M_{R(\text{Des})} = 1155 + 555 * R_{85\text{th}\%}$$

Where:

$$\text{Minimum } M_{R(\text{Des})} = 3,250 \text{ psi}$$

$$\text{Maximum } M_{R(\text{Des})} = 19,000 \text{ psi}$$

Our current practice utilizes a maximum $M_{R(Des)}$ of 12,000 psi for A-1-a material (R-Value = 30), unless project specific circumstances dictate otherwise. Higher $M_{R(Des)}$ values rely on stiff subgrade underlying the special borrow cap. It should be noted, this situation (placing special borrow on stiff subgrade) rarely occurs. Resilient Modulus is a measure of stiffness of the subgrade to a semi-infinite depth (~around 5 ft. deep).

Estimating M_R for Small Projects

Sometimes, the project designer asks for a pavement design where soil R-Value testing and/or FWD information is not available and will not be collected. This should occur infrequently, and only for small projects where the pavement quantity is too small to justify the cost of a soil survey, or there is not enough design time to allow for a soil survey.

In these cases, inquire with the NDT unit for FWD back-calculated M_R that may be available from past FWD testing. If FWD information is not available, the designer should estimate the “worst-case” R-Value that may be encountered on the project and design accordingly. Often, in areas of known fine-grained subgrades, the Minimum $M_{R(Des)} = 3,250$ psi is assumed for pavement design.

Subgrade Monitoring During Construction

Since subgrade strength is one of the primary inputs to flexible pavement design, it is important to monitor the subgrade during construction. The purpose of this is to ensure that the subgrade material is of equal or greater quality than the subgrade material that was assumed during the pavement design.

Subgrade and special borrow sources are approved prior to construction, and subgrade design checks are done during construction. Either R-Value testing and/or soils classification are used for borrow source approval and subgrade design checks. To ensure that these activities occur, include one of the following special provisions in to the contract when subgrade material is imported to the project:

- MDT Standard Special Provision 106-2a -Borrow Source Approval–Soil Classification,
- MDT Standard Special Provision 106-2b. Borrow Source Approval–Resistance Value, or
- MDT Standard Special Provision 106-2c. Borrow Source Approval-Soil Classification and Resistance Value.

Acceptance of subgrade material on the roadbed is generally done by soil classification.

A note showing the design R-Value should be located next to the typical sections within the Plans. The note’s purpose is to notify construction personnel of the design R-Value, and help them identify material that does not meet the pavement design requirements.

R-Value testing is used as a final design check during construction. The procedure is described in the Materials Manual. This testing is not a construction

contract requirement. It is the final check to ensure that the subgrade material meets the properties assumed during the pavement design. MDT's Construction Memorandum "R-Value Testing of Finished Subgrade" provides guidance on R-Value testing and is provided at the following website:

[MDT Construction Memorandum for R-Value Testing of Finished Subgrade](#)

5.6 FLEXIBLE PAVEMENT DESIGN STEPS

Flexible pavement design process consists of the following steps:

1. Determine design inputs to calculate structural number ($SN_{Req'd}$)
2. Calculate $SN_{Req'd}$
3. Design a pavement structure with $SN_{des} \geq SN_{req'd}$
4. Specify pavement materials
5. Send pavement design and materials memorandum

Step 1: Determine Pavement Design Inputs

Most of the work involved in pavement design involves determining the inputs needed to calculate the $SN_{Req'd}$, including:

- Total 18-kip ESALs Over Pavement Design Life
- Initial Serviceability ($p_o = 4.2$)
- Terminal Serviceability ($p_t = 2.5$)
- Reliability Level (varies by route type)
- Overall Standard Deviation (S.D. = 0.45)
- Roadbed Soil Resilient Modulus (from R-Value and FWD testing)
- Number of Construction Stages (1)

These inputs are discussed in detail within the following sections.

Step 2: Determining Required Structural Number ($SN_{req'd}$)

The design inputs determined in Step #1 are used to calculate $SN_{req'd}$. $SN_{req'd}$ is the SN required for satisfactory pavement performance over the design life. The design equation found in the 1993 Guide may be calculated using the nomograph, a spreadsheet, or the DARWin software. Using the DARWin software is the preferred method of determining $SN_{req'd}$. A design example using DARWin is found later in this section.

Step 3: Design a Flexible Pavement Swith $SN_{des} \geq SN_{req'd}$

Step #3 consists of choosing the material type and thickness for each pavement layer.

The first task is to choose which materials are to be used for the pavement structure. For flexible pavements, the top layer will always be PMS. However, the

pavement designer may choose to use different types of materials beneath the PMS. MDT's pavement types are as follows:

- **Two layer pavements:** PMS under laid by base course (Exhibit 5-13). The base course usually consists of either crushed aggregate course (CAC) or cement treated base (CTB) placed upon the finished subgrade.

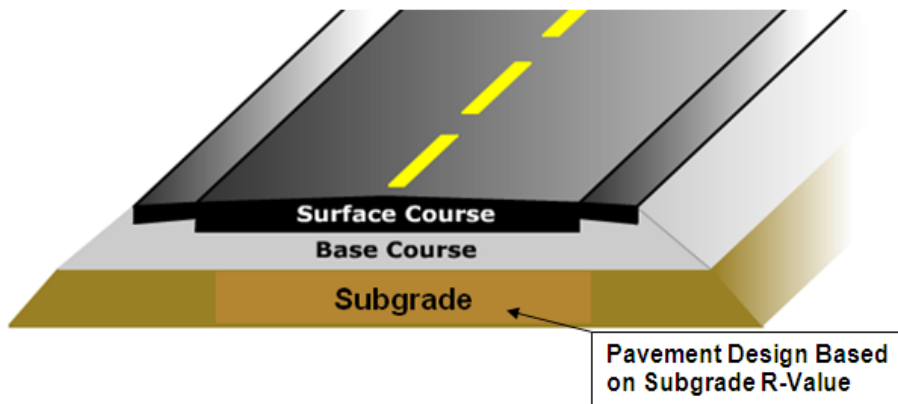

Exhibit 5-13
Two Layer Pavement Section

- **Three layer pavements:** Refers to PMS layer under laid by a base course and subbase course (Exhibit 5-14). The subbase course usually consists of a drainable pit run granular material, but may consist of other granular materials that are locally available.

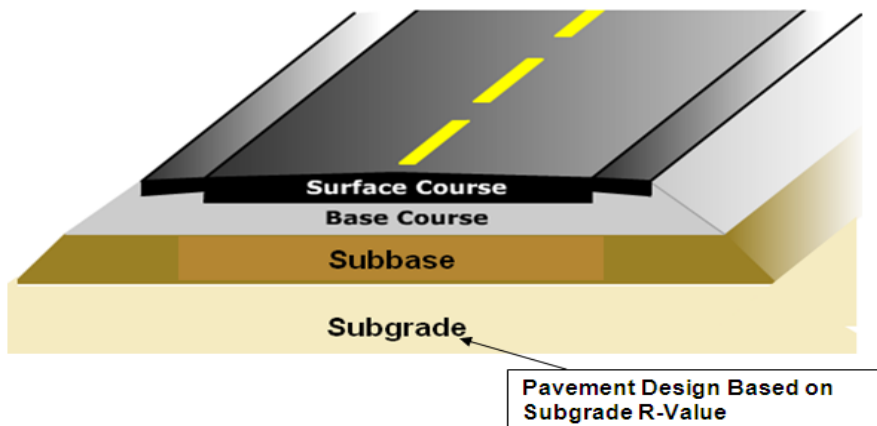
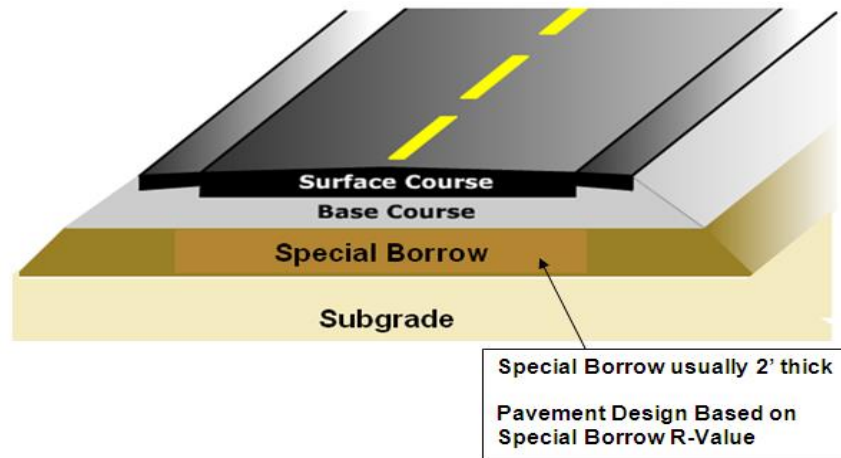

Exhibit 5-14
Three Layer Pavement Section

- **Special borrow pavement:** A special borrow pavement is either a two or three layer under laid with a 2 ft. thick special borrow layer (see Exhibit 5-15). Usually, special borrow is specified based on R-Value, and consists of a granular material that is both locally available and is of better quality than the native subgrade. Special borrow is often used to reduce the thickness of the overlying layers, to aid in constructability by “bridging” underlying weak subgrade soils, or to provide more granular material thickness to mitigate frost heaving.

Exhibit 5-15
Special Borrow
Pavement Section

There are instances in which less than 2 ft. of special borrow may be used. When less than 2 ft. of special borrow is specified, the special borrow should be treated like a subbase material and designed similar to a three layer pavement.



After the pavement type(s) have been selected, the next step is to design the pavement layer thicknesses. SN_{Des} and pavement layer thicknesses are designed using the following equation:

$$SN_{Des} = a_{PMS} \cdot d_{PMS} + a_{Base} \cdot d_{Base} + a_{Subbase} \cdot d_{Subbase} \geq SN_{Req'd}$$

Where:

SN_{Des} = SN of design pavement section

$SN_{Req'd}$ = SN required for satisfactory pavement performance over the design life.

a_{PMS} , a_{Base} , a_{Sub} = structural-layer coefficients of PMS, base, and subbase layers, respectively.

d_{PMS} , d_{Base} , d_{Sub} = thickness of PMS, base, and subbase layers, respectively.

The following steps are based on the equation above and can be used to design pavement layers:

1. Select PMS thickness:

PMS thickness is chosen based on daily ESALs and the pavement location as shown in Exhibit 5-4. Use the following equation to calculate the amount of structure provided by the PMS:

$$SN_{PMS} = \text{PMS structural coefficient} * \text{PMS thickness} = a_{PMS} * d_{PMS}$$

Where:

a_{PMS} = PMS structural coefficient

d_{PMS} = PMS thickness (ft.)

2. Select Base thickness:

After the PMS thickness has been chosen, calculate SN that will be provided by the base course. For pavements without subbase, use the following equation.

$$SN_{base} \geq SN_{Des} - SN_{PMS}$$

Calculate base course thickness:

$$d_{base} = SN_{base} / a_{base}$$

Where:

a_{base} = Base course structural coefficient

d_{base} = Base course thickness (ft.)

3. Select Subbase type and thickness (when applicable):

After both the PMS and base course thicknesses have been designed, calculate the structure that will be provided by the subbase course:

$$SN_{Sub} = SN_{Des} - SN_{PMS} - SN_{Base}$$

Calculate subbase course thickness:

$$d_{Sub} = SN_{Sub} / a_{Sub}$$

Where:

a_{Sub} = Subbase course structural coefficient

d_{Sub} = Subbase course thickness (ft.)

Step 4: Specify Pavement Layer Materials

See Chapter 3.

Step 5: Send Pavement Design Memorandum to Project Design Manager.

Now that the thickness design and pavement materials have been determined, the last task is to save the Surfacing Design Memorandum to the document management system and to send a link to the distribution list via email.

Appendix B shows an example Surfacing Design Memorandum.

After completing the surfacing design memorandum with Microsoft Word, save the .docx file to the Surfacing Design Unit shared drive. Also save the file as *.pdf file to be uploaded to the document management system. Appendix C outlines the steps to name the file and upload the document. Projects designed by a consultant will be handled within the corresponding activity in the appropriate flowchart. Once the memorandum has been submitted for distribution and saved, the EPS activity may be carded off.

5.7 REFERENCES

1. AASHTO. *Guide for Design of Pavement Structures*. AASHTO, Washington D.C., 1993.
2. Pavement Interactive. *1993 AASHTO Flexible Pavement Design Equation*. Website: www.pavementinteractive.org.
3. Darter, A.-O. *Relationships Between IRI and PSR*. Springfield: Illinois Department of Transportation. Omari and Darter, 1992.
4. Transportation Research Board (TRB). *NCHRP 2-37A Development of the 2002 Guide for the Design of New and Rehabilitated Pavement Structures*. TRB, Washington, D.C., 2004.
5. FHWA. *Design Pamphlet for The Backcalculation of Pavement Layer Moduli in Support of The 1993 Aashto Guide for The Design of Pavement Structures*. FHWA-RD-97-076. FHWA, Washington, D.C., 1997.

MONTANA DEPARTMENT OF TRANSPORTATION

PAVEMENT DESIGN MANUAL

Chapter 6

Flexible Pavement Rehabilitation

November 2018



Contents

CHAPTER 6 FLEXIBLE PAVEMENT REHABILITATION 6-1

6.1 Introduction	6-1
6.2 Minor Rehabilitation	6-2
6.3 Major Rehabilitation	6-4
6.3.1 Pavement Pulverization.....	6-5
6.3.2 Flexible Pavement Rehabilitation Design	6-10
6.4 References	6-19



Chapter 6

Flexible Pavement Rehabilitation

6.1 INTRODUCTION

Rehabilitation is a strategy to extend a pavement's useful life through pavement structure improvement utilizing the in-place materials. Rehabilitation is considered in two categories: minor and major. These categories are explained further in Exhibit 6-1.

Category	Minor Rehabilitation	Major Rehabilitation
Surface Engineering	Engineered Design	Engineered Design
Geometric Design Standards	As Built	Ranging from As-Built to Current Standards
Applied Treatments	0.2' ≤ overlay ≤ 0.3' Milling ≤ 0.2' No exposure of base gravel	≥0.2' overlay w/ grading Pulverization Mill, recycle and overlay Exposed gravel may be treated or modified
How Needs Are Identified	Observed Distress	Observed Distress Geometrics
Design Life	≥10 years	≥20 years

Exhibit 6-1
Minor vs. Major Rehabilitation

6.2 MINOR REHABILITATION

The intent of these projects is to rehabilitate the existing pavement surface through an engineered approach that considers the observed pavement distress and in-place materials. Design guidelines for minor rehabilitation projects are defined in MDT/FHWA's *Guidelines for Nomination and Development of Pavement Projects* which is available upon request and provided at the following website (1):

[Guidelines for Nomination and Development of Pavement Projects](#)

Design Method: Engineered judgment, engineered overlay (see Chapter 7), estimated structural number on assumed properties.

Design Life: 10-years design life.

Minor rehabilitation is intended for pavements that are structurally sound to restore the functional condition of the pavement. This usually refers to restoring the ride and rut condition of the pavement. Pavements where there is significant load-associated cracking or obvious base course and subgrade issues should not be minor rehabilitated, as minor rehabilitation of these pavements will probably not last the required 10-year design life.

Some minor rehabilitation treatments that have been utilized by MDT include:

- Asphalt overlay,
- Asphalt mill and fill,
- Cold in-place recycling overlaid by a chip seal or an asphalt overlay, and
- Hot in-place recycling with chip seal.

The information needed for minor rehabilitation design includes observation of existing pavement distress and in-place materials. Observation involves analyzing Pavement Management System (PvMS) pavement condition data to determine the pavement's rut, ride, and cracking characteristics and visual observation done during the preliminary field review. Characterization of the in-place materials usually pertains to the Plant Mix Surfacing (PMS) layer only and usually consists of pavement cores and GPR analysis to determine PMS condition and thickness.

Since information is not collected for the base course or subgrade materials, it is not usually practical to design these projects using the 1993 Guide structural number method (2). Instead, engineering judgment and past pavement performance are used to determine the pavement treatment that cost effectively provides the desired design life. Using GPR thickness data and FWD subgrade information, a structural number can be estimated.

Minor rehabilitation should be designed to correct the most critical pavement distress. The critical pavement distress for minor rehabilitation is usually minor roughness and alligator cracking *or* minor to major rutting and transverse cracking. Use Exhibit 6-2 to help to determine the appropriate minor rehabilitation strategy.

Exhibit 6-2: Minor Rehabilitation Goals and Treatment Selection

Distress	Minor Rehabilitation Goal	Example Treatments
Minor Alligator Cracking	Add pavement structure and seal pavement	Mill <= 0.2', Overlay <= 0.3', cold or hot in-place recycle with overlay
Rutting	Correct or remove pavement ruts	<p>Follow the following guidelines to determine treatment:</p> <ol style="list-style-type: none"> 1. Establish that Rutting is confined to upper PMS layer. If rutting exists in lower layers, it is not a Minor Rehabilitation Candidate. 2. Establish whether PMS is stable or unstable. If rutting is an ongoing phenomenon, the PMS may be unstable. If rut depth has stabilized and is not becoming deeper, the PMS is stable. This determination is often made by observing PvMS data and graphing rut depth vs. time. <p>Stable PMS: Microsurfacing, PMS leveling with overlay, mill/fill</p> <p>Unstable PMS: Mill/fill as deep as necessary to remove unstable PMS</p> <p>Do not use in-place recycling to treat stable or unstable rutting unless an overlay is placed over the recycled material. Rutting has been shown to reoccur when in-place recycling previously rutted pavements.</p>
Minor Roughness	Restore ride quality	Overlay that includes a leveling quantity, mill/fill, cold or hot in place recycle with overlay
Minor Transverse Cracking (does not affect ride)	Seal pavement with emphasis on transverse cracks	Seal cracks followed by leveling course and overlay, mill/fill, hot in-place recycle followed by chip seal, cold in-place recycle followed by chip seal (low-volume only)
Major Transverse Cracking (affects ride)	Restore ride, seal cracks, add pavement structure	Mill/fill (low volume), mill/fill with additional overlay, cold or hot in-place recycle with overlay

6.3 MAJOR REHABILITATION

The intent of these projects is to rehabilitate the existing pavement structure through an engineered approach that considers the observed pavement distress, in-place materials, and roadway geometrics. Milling operations may be > 0.20 ft. and may expose base gravel that can be treated or modified. New right-of-way and utility relocation may be required to improve geometrics, to flatten slopes, or enhance safety. Appropriate soil survey work, subsurface analysis, traffic data and accident data must be collected.

Major rehabilitation usually occurs in situations where:

- An existing pavement is in good condition, but pavement structure needs to be added to accommodate growing traffic levels.
- An existing pavement is distressed, and the distress cannot be remediated with lesser pavement treatments.
- The existing pavement is in good condition but is too narrow for growing traffic levels. In this case, the existing pavement is usually major rehabilitated and widened to meet today's roadway width standards.

Design guidelines for minor rehabilitation projects are defined in MDT/FHWA's *Guidelines for Nomination and Development of Pavement Projects* which is available upon request and provided at the following website (1):

[Guidelines for Nomination and Development of Pavement Projects](#)

Design Method: An engineered design based on a thorough pavement investigation and using the design method described in **Error! Reference source not found.**

Design Life: 20-years design life.

There are instances in which major rehabilitation projects are upgraded to reconstruction projects. This usually occurs where the horizontal or vertical road alignment changes significantly to meet geometric design standards. As a rule, major rehabilitation projects where more than 25% of the project length needs to be realigned should be upgraded to reconstruction.

In the past, there have been a number of major rehabilitation projects that escalated to reconstruction late in the project design phase. This is usually due to alignment issues rather than pavement issues. Discussions should take place early in the design process to ensure that major rehabilitation is truly possible.

Major rehabilitation pavements are usually designed and built using one of the following methods:

1. Pavement pulverization [also known as Full Depth Reclamation (FDR)]
2. Engineered overlays (with or without grade raise)
3. Cold Central Plant Recycling (CCPR)
4. White Topping

Two common pavement types are discussed in the following sections.

6.3.1 Pavement Pulverization

Pavement pulverization is the mixing of existing PMS and base course together to form a crushed base course for a new pavement. The PMS and base course mixture is known as a “pulverized mixture” and is manufactured using a pavement reclaimer as shown in Exhibit 6-3 and Exhibit 6-4.

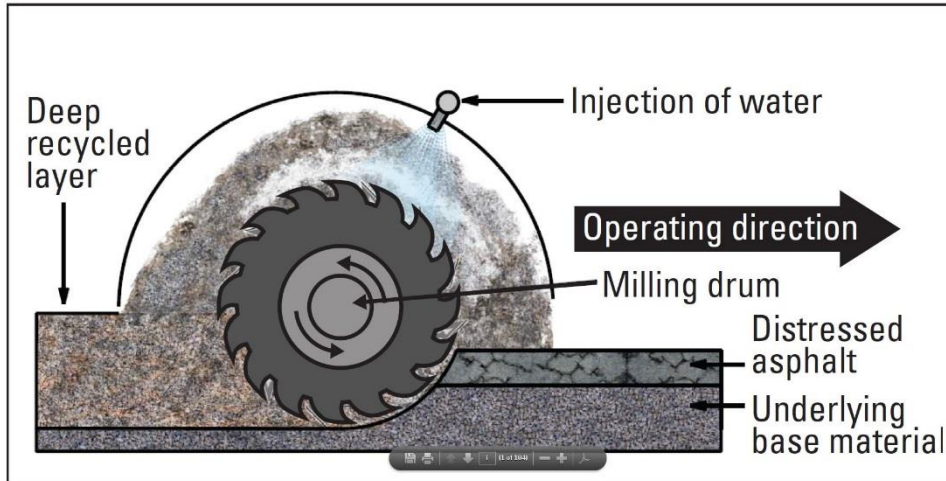

**Exhibit 6-3
Pavement Pulverization
Schematic**

This process works well when:

- The horizontal and vertical alignment will be left unchanged or changed slightly.
- There is a desire to stay within existing right-of-way limits.
- The existing PMS is distressed, but the underlying base course is in good condition and has adequate thickness to provide both the required pavement structure and a construction platform for pulverization operations.



**Exhibit 6-4
Pavement
Pulverization**

Photo Source: MDT

Usually these pavements are built as follows:

1. A portion of existing PMS may be milled and removed prior to pulverizing. This is done in order to reduce the PMS amount in the pulverized mixture or to reduce the increase in vertical elevation of the finished pavement.
2. Virgin CAC may be placed upon the milled or unmilled PMS surface to reduce the PMS amount in the pulverized mixture or to add pavement structure.
3. The surface is pulverized, shaped, and re-compacted in-place. Additives such as Portland Cement may be added to increase pavement structure.
4. After placing aggregate treatment on the pulverized material, PMS is placed to provide the new surfacing course.

The following are other design details for pavement pulverization:

- 0.65 ft. is the most common pulverization depth which corresponds to MDT's maximum compacted lift depth. Deeper pulverization can be done, but the 0.65 ft. maximum compacted depth must be adhered to.
- It is important to have a consistent blend of pulverized PMS and CAC. Within the blend, pulverized PMS should comprise a maximum 60% of the pulverized mixture. MDT research has shown that pulverized mixture shear strength decreases when PMS comprises more than 60% of the mixture (3).
- Compacted pulverized material should be assumed to have up to 5-15% swell factor.

Exhibits 6-5 and 6-6 show typical sections on major rehabilitation projects from sample previous MDT Construction plans.

Exhibit 6-5 Pavement Pulverization without Widening

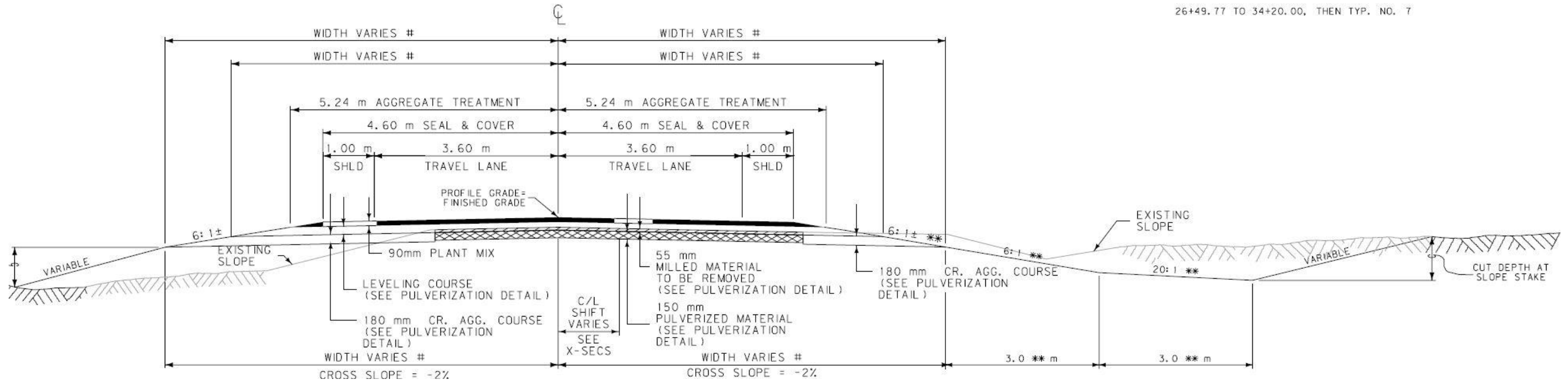
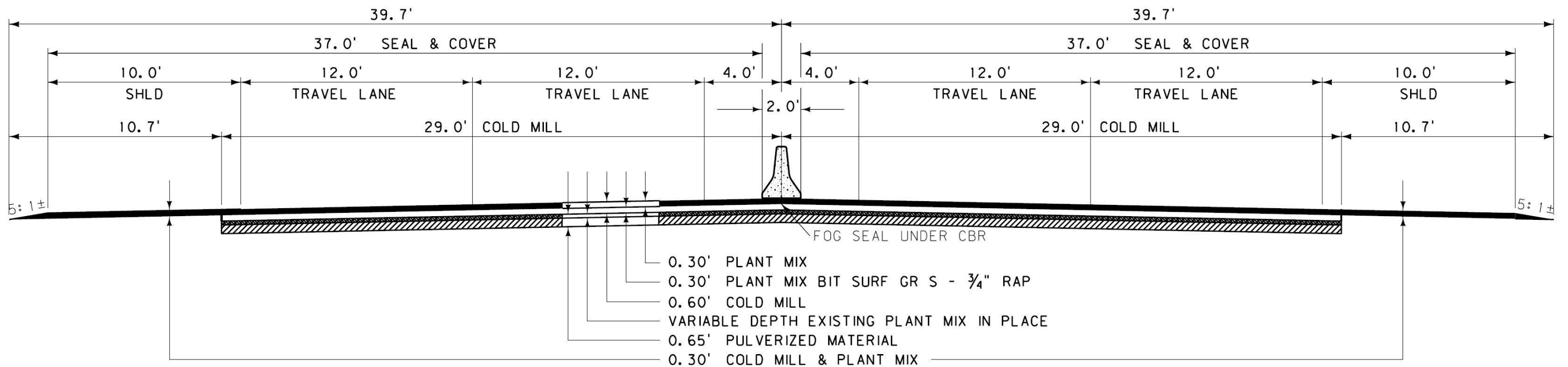

Exhibit 6-6 Major Rehabilitation with Pulverization and Major Widening



This page intentionally left blank.

Project Selection

The appropriate candidate for pulverization needs to be verified early in the design stage. One factor to successful pulverization is to have limited to no change to the vertical alignment. If the existing vertical alignment undulates compared to the corrected vertical profile, pulverization is not feasible. The primary reason is due to the conflict where the existing profile protrudes up into the proposed typical section (cut sections).

Pulverization depth is limited by the ability to compact the blended base. MDT specifications call for a maximum of 8 in. compacted lift. Some reclaimers can pulverize up to 20 in. deep; however, the maximum pulverization depth is driven by the plant mix thickness. The existing plant mix should not be more than 8 in. (0.65 ft.) thick for pulverization. At that maximum, a 16 in. depth would be required to obtain a 50/50 blend. In this case, 8 in. would be required to be bladed off in order to compact the remaining pulverized 8 in. per MDT's specifications. This could be a viable option for projects that incorporate widening.

Caution should be used when considering pulverization on projects with existing cement treated base. CTB can be pulverized, but this can cause difficulties. A combination of milling and pulverization may be necessary. Also, MDT's CTB aggregate gradation allows up to 20% minus 200 mesh, while having a maximum aggregate size of 1 in. This has been rarely encountered in Montana.

On projects with very weak, soft subgrades and thin existing gravel sections the use of pulverization should be questioned. When utilizing the pulverized base for design, the bottom 0.2 ft.-0.4 ft. should not be accounted to contribute to the structural number.

When the soil survey encounters high fines in the base, the designer should again question the use of pulverization. Pulverized plant mix typically contains around 8% minus 200 mesh. When blended with base, the plant mix will help to reduce the fines content of the mixture. It should be noted that historically MDT's gravel specification allowed for up to 12% minus 200 mesh, whereas the current specification allows for only up to 8% passing the 200 mesh. The estimated weighted average of the pulverized blend should not exceed 10% passing the 200 mesh unless approved by the pavement analysis engineer.

Pulverized Pavement Constructability

MDT has encountered problems with the constructability of pulverization projects. The most common problem is the pulverized surface's inability to support traffic before it is paved over. This may result from thin existing pavement thickness and/or fine-grained, saturated subgrade materials. Either of these scenarios may result in subgrade material pumping up into pulverized section and ruining the pulverized material.

A thorough pavement evaluation of the following needs to be completed before pavement design:

PMS thickness: The PMS thickness should be measured continuously along the project length. The purpose of this is to determine the pulverization depth and/or milling depth needed to meet the blend requirements, and to ensure that the

pulverizer teeth do not extend into the subgrade material. GPR is an effective way to continuously measure PMS thickness. The soil survey PMS depths can also be used.

CAC thickness and condition: A soils survey (MT-207) should be completed to determine the in-place CAC thickness, condition, and moisture level. FWD data can be used in addition to the soil survey to determine CAC stiffness.

Subgrade type and condition: Similar to CAC, both a soil survey and FWD testing can be used to identify unstable subgrades. Subgrade moisture contents above optimum may indicate soft, pumpable soils.

After the pavement evaluation has been completed and pavement pulverization is determined to be feasible, follow these design procedures to improve constructability:

- **Do not lower pavement grade.** The finished pulverized surface should be at or above the existing pavement grade. Lowering the grade will reduce pavement structure and reduce construction platform strength.
- **Include contract language to not allow pulverization in the wetter spring months.**
- **Include contract language to limit the amount of time both public and Contractor traffic are allowed to travel on the pulverized material.** Provide alternative haul routes so that heavy construction traffic does not travel on pulverized material.

6.3.2 Flexible Pavement Rehabilitation Design

MDT's pavement rehabilitation design is based upon the method presented in the 1993 Guide Part III, with modifications presented in this Pavement Design Manual. This section outlines the steps for flexible pavement rehabilitation design. Appendix D provides an example of this type of design.

The following equation is used to design rehabilitation projects:

$$SN_{dgn} - SN_{eff} = SN_{ol}$$

Where:

SN_{dgn} = The structural number required for future traffic loading. Also known as SN_f (Structural number to carry future traffic) in the 1993 Guide.

SN_{eff} = Existing pavement structural number.

SN_{ol} = The structural number deficiency between the existing pavement and that needed for the future pavement design. This is the amount of pavement structure that needs to be added with an overlay.

Generally, pavement rehabilitation design includes the following steps:

- **Step #1** Based on the existing pavement condition, layer thicknesses and quality, geometrics, structural capacity, and funding category recommend a rehabilitation method.
- **Step #2** Determine existing pavement structural capacity (SN_{eff}).
- **Step #3** Determine future pavement structural capacity (SN_{dgn}).
- **Step #4** Specify construction methods and materials.
- **Step #5** Send pavement design and materials memorandum.

Step 1: Determine Pavement Rehabilitation Method

Recommend a rehabilitation method based on the existing pavement condition, layer thicknesses and quality, geometrics, structural capacity, traffic, and funding category.

Choosing a rehabilitation method is heavily based on engineering judgment. Each pavement is unique, and there are usually a number of ways to rehabilitate a given pavement. The best method is one that meets the needs of the pavement designer, road designer, planning personnel, traveling public, safety, and the project budget. The designer should communicate with the road designer to ensure that the chosen rehabilitation method will fit within the broader project constraints.

Visually evaluating the pavement condition is the single most important input to making this decision. By evaluating the pavement distress, as well as the distress mechanisms that cause the distress, the designer determines whether the pavement distresses are functional or structural:

- **Functional distresses** refer to those distresses that affect the traveling public, such as rough ride or low pavement friction. Those distresses, although a nuisance, can happen on a pavement that is structurally sufficient. Pavements with functional distress tend to need less expensive surface treatments to restore the pavement serviceability and extend its design life. These projects are often referred to as pavement preservation. An example of this would be a chip seal.
- **Structural distresses**, such as deep pavement rutting and alligator cracking, are an indication of inadequate pavement. Structural distress often needs deeper, more expensive rehabilitation in order to meet the desired design life.

Engineered overlays are the preferred method to rehabilitating pavements with functional distress that require additional structure. Milling, pulverization, or in-place recycling should be used to treat structural distresses. Exhibit 6-7 shows a flowchart to serve as a starting point for when choosing a rehabilitation method. In addition to the issues defined in the flowchart, other issues that influence this decision include:

- **Traffic Volume:** There are times when heavy traffic volumes will influence the rehabilitation treatment decision, and the design team may want a more conservative treatment than shown in the flowchart.

Conversely, on low volume roads, there may be a desire to be less conservative in the pavement design. This may mean an engineered

solution that effectively “bridges” over a problem pavement rather than treats its structural distress directly. An example of this is designing a thick engineered overlay over a pavement with base course distress.

- **Pavement Grade Raise:** Often, in order to reduce roadside slope work or reduce right-of-way take, the pavement rehabilitation needs to be designed to reduce or eliminate pavement grade raise.

Exhibit 6-7 Major Rehabilitation and Engineered Overlay Selection Flowchart

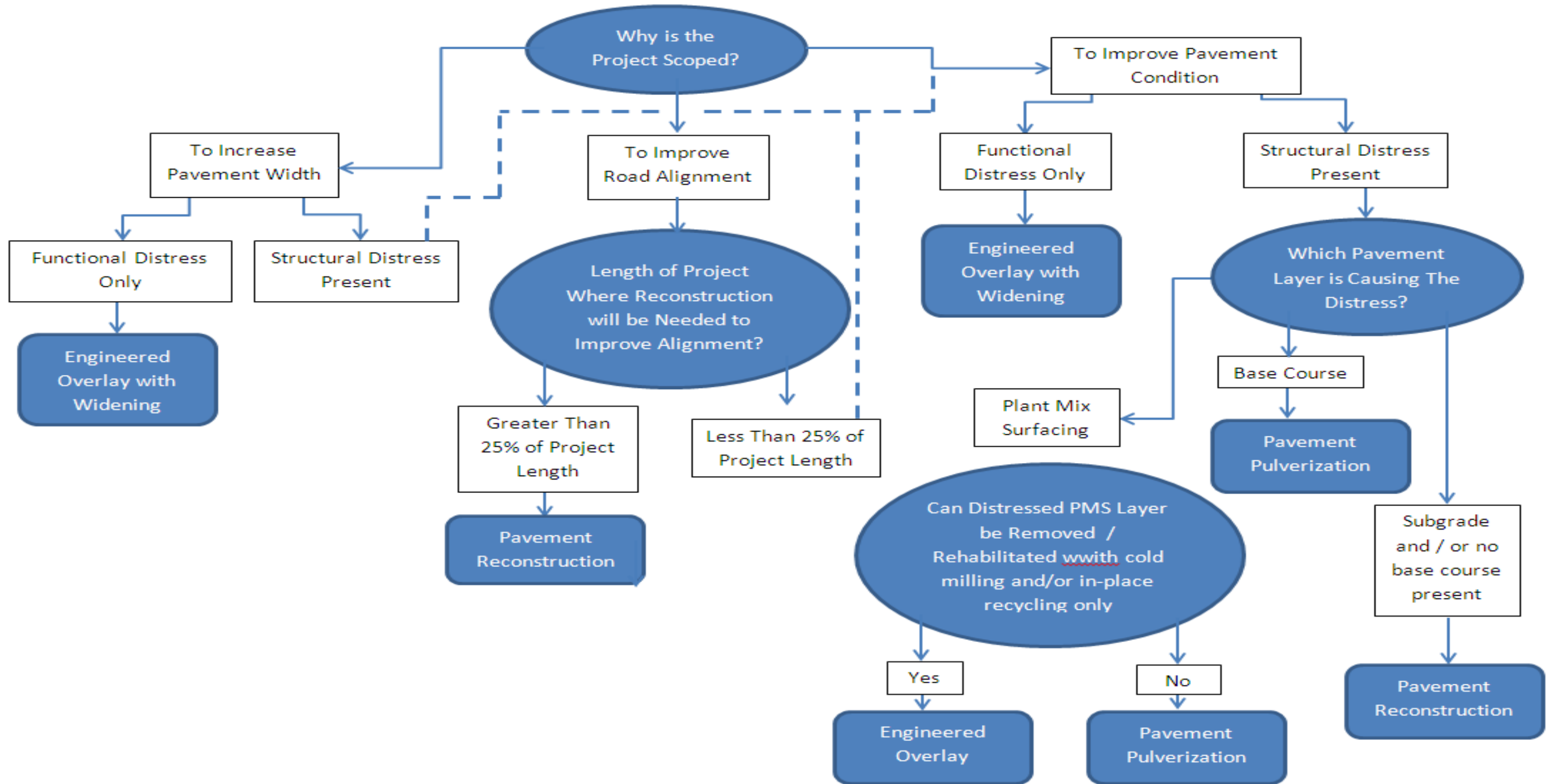

This page intentionally left blank.

Step 2: Determine Existing Pavement Structural Capacity (SN_{eff})

MDT usually calculates the structural capacity of the existing pavement (SN_{eff}) by analyzing the existing pavement. This analysis includes calculating the SN of each existing pavement layer and summarizing the SN of all layers to calculate SN_{eff}. The equation used to determine the structural capacity of the existing pavement is:

$$\begin{aligned} \text{SN}_{\text{eff}} &= \text{SN}_{\text{PMS}} + \text{SN}_{\text{Base}} + \text{SN}_{\text{sub}} \\ &= d_{\text{PMS}} a_{\text{PMS}} + d_{\text{Base}} a_{\text{base}} + d_{\text{sub}} a_{\text{sub}} \\ &= \sum_1^n d_{\text{PMS}n} a_{\text{PMS}n} + d_{\text{Base}} a_{\text{base}} + d_{\text{sub}} a_{\text{sub}} \end{aligned}$$

Where:

SN_{eff} = The structural number of the existing pavement

d_{PMS}, d_{Base}, d_{Sub} = Average thicknesses of the existing PMS, Base Course, and Subbase Course (ft. or in.)

a_{PMS}, a_{base}, a_{sub} = The average effective structural coefficient of the existing PMS, Base Course, and Subbase Course layers

n = Number of individual PMS lifts within the existing pavement. Often, each lift (layer) of PMS have different levels of degradation. In these cases, the SN of each lift is calculated separately.

SN_{eff} = The structural number of the existing pavement

Use the methods presented in the rest of this section to determine both pavement layer depths and structural coefficients.

Existing Pavement Evaluation

The most challenging task in designing a major rehabilitation is determining the structural contribution of the existing pavement, or SN_{eff}. MDT relies on pavement borings and NDT of the existing pavement to estimate both pavement layer thicknesses and structural coefficients. These are expanded on below:

- **NDT Testing:** This refers to the FWD and GPR testing done by MDT's NDT unit. FWD testing is analyzed to provide the Resilient Modulus (M_R) of each pavement layer and subgrade material. GPR testing provides a continuous measurement of the PMS thickness. This testing is further discussed in Chapter 7 and Chapter 14.
- **Existing Pavement Sampling and Testing:** The District conducts a centerline soil survey and PMS core stripping evaluation to measure the thickness and quality of existing pavement layers. The following pavement characteristics are measured:
 - PMS, base, and subbase thicknesses.

- Base Course Soils Class, Gradation, Atterburg Limits, Natural (in-place) Moisture Content, Optimum (Proctor) Moisture Content, and R-Value. Usually, there is not enough material from any given bore hole, so composite base course samples from a number of bore holes are combined. Note that this results in “average” properties of the in-place base materials.
- Subgrade Soils Class, Gradation, Atterburg Limits, Natural (in-place) Moisture Content, Optimum (Proctor) Moisture Content and R-Value.

The soil sample is done in accordance with MT-207, and the results are presented on Materials Form 111. A sample Form 111 is shown in Appendix D, Exhibit D-7.

Step 3: Determine Future Pavement Structural Capacity (SN_{dgn})

Determine SN_{dgn} by using the same procedure for new or reconstructed pavements outlined in **Error! Reference source not found.5**.

Complete Pavement Rehabilitation Design

Design a rehabilitation pavement section that increases the existing pavement structure and performs well over the design life. Often, a pavement widening section has to be designed in addition to the rehabilitated section (see the example typical sections in **Error! Reference source not found.** for more information on widening sections).

Completing the Rehabilitated Pavement Design

Determine the amount of pavement structure that will be added to the existing pavement to perform well over its anticipated design life. This is done using the following equation:

$$SN_{dgn} - SN_{eff} = SN_{ol}$$

Where:

SN_{dgn} = The structural number required for future traffic loading determined during Step #3.

SN_{eff} = The structural number of the existing pavement determined during Step #2.

SN_{ol} = The structural number deficiency between the existing pavement and that needed for the future pavement design. This is the amount of pavement structure that needs to be added during pavement rehabilitation.

The additional pavement structure, SN_{ol} , is added by either adding additional pavement thickness or improving the strength of the existing pavement layers. Additional pavement thickness is usually added by adding additional CAC and/or

PMS to the existing pavement. Improving the existing pavement strength can be done by:

- PMS layer:
 - Mill existing weak PMS and replace with new PMS.
 - Improve existing pavement strength using in-place recycling.
- Base or subbase layer:
 - Use pulverization to mix weak and/or contaminated base course with overlying PMS material. The pulverized mixture usually adds strength and drainage, and reduces the amount of fines when compared to the existing base layer.
 - Use pulverization to add stabilizing agents (usually Portland Cement) to the existing base.

Completing the Widening Section Design

The pavement widening section design is usually designed similarly to a new pavement. Follow the steps in Chapter 5 to design the widening section.

Also consider the following when designing widening sections:

- Consider using the material from the rehabilitation section within the widening section. For example, pulverized material can be bladed over to provide CAC needed for the widening section. Pavement millings can also be blended with virgin CAC to provide CAC for the widening section.
- The widening sections base course should extend to or below the depth of the existing gravel section. This facilitates drainage and avoids designing a “bathtub” pavement section.
- Can the PMS section be thinner than the adjacent rehabilitated section? The designer should approach this with caution, but if the widening section will be a pavement shoulder with little or no traffic loading, consider using a thinner PMS layer upon the widening section. Consider the following guidelines:
 - The minimum shoulder thickness should be 0.30 ft. PMS in order to provide depth for future milling operations.
 - The designer should not thin shoulders on Interstate pavements, pavements where future traffic lanes may be placed on the shoulder, or shoulders that may become traveled upon if turning lanes are installed in the future.

Step 4: Specify Pavement Materials and Construction Methods

Specify materials to be used within the designed pavement using the same procedure for new or reconstructed pavements. This process is outlined in **Error! Reference source not found.**

Step 5: Send Pavement Design Memorandum

Send a surfacing design memorandum to the road design staff via interdepartmental mail. Appendix B shows an example surfacing design memorandum. The following list includes items that are included on the surfacing design memorandum.

- To: Highways Engineer
- Thru: Pavement Design Engineer (with signature)
- From: Designer (with signature)
- Date
- Subject Project Number, Name, and CN Number
- Designate Preliminary or Final and EPS Act. 600 or 604, respectively
- PMS, CAC, and total thicknesses for both the rehabilitation and widening sections
- A description of milling and pulverization depths
- Thorough description of the type and order of construction operations needed for pavement rehabilitation
- Description of stabilizers (i.e. Portland cement)
- Design R-Value
- The daily ESALs used for design
- Plant mix type
- Use of RAP and PMS RAP content
- Design life length (in years)
- Binder type
- Asphalt content
- Copied to District Administrator, Road Design Engineer, Road Design Project Manager, Surfacing Materials, and Geotechnical

An effort should be taken to make the surfacing design memorandums as detailed as needed in order for the road designer to develop both project reports and construction plans.

Verify that the correct distribution has been used. After completing the surfacing design memorandum in Microsoft Word, save the .docx file to the Surfacing Design Unit shared drive. Also save the file as *.*.pdf file to be uploaded to the document management system. Appendix C outlines the steps to name the file and upload the document. Projects designed by a consultant will be handled within the corresponding activity in the appropriate flowchart.

Once the memorandum has been submitted for distribution and saved, the EPS activity may be carded off.

When the paper copy of the memorandum is distributed, the original copy is stamped "Master Copy" with a green stamp by the Department's mail staff and sent back to the Surfacing Design Unit. This "Master Copy" is stored in the Surfacing Design project file.

6.4 REFERENCES

1. MDT and FHWA. Guidelines for Nomination and Development of Pavement Projects. MDT, Helena, MT, 2017.
2. AASHTO. Guide for Design of Pavement Structures. AASHTO, Washington D.C., 1993.
3. MDT. Evaluation of Engineering Characteristics of RAP/Aggregate Blends. MDT, Helena, MT, 2005.

MONTANA DEPARTMENT OF TRANSPORTATION

PAVEMENT DESIGN MANUAL

Chapter 7

Engineered Overlays

November 2018



Contents

CHAPTER 7 ENGINEERED OVERLAYS	7-1
7.1 Introduction.....	7-1
7.2 Engineered Overlays for Minor and Major Rehabilitation	7-1
7.3 Engineered Overlays on High vs. Low Volume Roads	7-5
7.4 Isolation and Leveling Lifts.....	7-5
7.4.1 Isolation Lifts.....	7-5
7.4.2 PMS Leveling Quantity	7-6
7.5 Engineering Overlay Design	7-7
7.5.1 Determine SN_{eff} From In-situ Destructive Testing.....	7-9
7.5.2 Determining SN_{eff} from NDT information	7-9
7.5.3 Completing the Widening Section Design.....	7-12
7.5.4 Spreadsheet Solution for Calculating SN_{eff} , SN_{dgn} , and SN_{ol}	7-12
7.6 References	7-15



Chapter 7

Engineered Overlays

7.1 INTRODUCTION

An engineered overlay returns the pavement to a high serviceability level and provides the strength for the pavement design life. It is designed to mitigate existing pavement distress and material defects. Engineering overlays can be done for minor and major rehabilitation projects.

7.2 ENGINEERED OVERLAYS FOR MINOR AND MAJOR REHABILITATION

For a minor rehabilitation project (Work Type 160), a minimum of 10 years for the design life is required. The need for milling is determined by the designer based on the existing pavement condition. The overlay should provide additional pavement structure needed for the pavement design life, and correct existing pavement distresses and/or pavement material problems so that those issues do not affect performance of the engineered overlay. A grade raise can be accommodated (~0.2 ft. to 0.3 ft.).

An engineered overlay should be considered on portions of major rehabilitation projects in which the following conditions are met:

- The horizontal and vertical alignment are not going to change along most of the project length.
- A grade raise can be accommodated (~0.2 ft. to 0.5 ft.).
- A pavement design life of 20 years can be achieved.
- The existing pavement, and in particular the PMS layer, is in good condition.
- The existing plant mix does not have excessive cracking.
- Overhead clearance at grade separations needs to be considered on thick overlay projects.

Engineered overlays can be a cost effective and relatively fast method for rehabilitating an existing pavement. An engineered overlay is also particularly useful for pavement widening projects since the existing pavement can be used to carry traffic while the widening section(s) are built. Exhibit 7-1 illustrates an engineered overlay design with deep pavement milling, and Exhibit 7-2 illustrates engineered overlay with widening section.

Exhibit 7-1 Engineered Overlay Design with Deep Pavement Milling

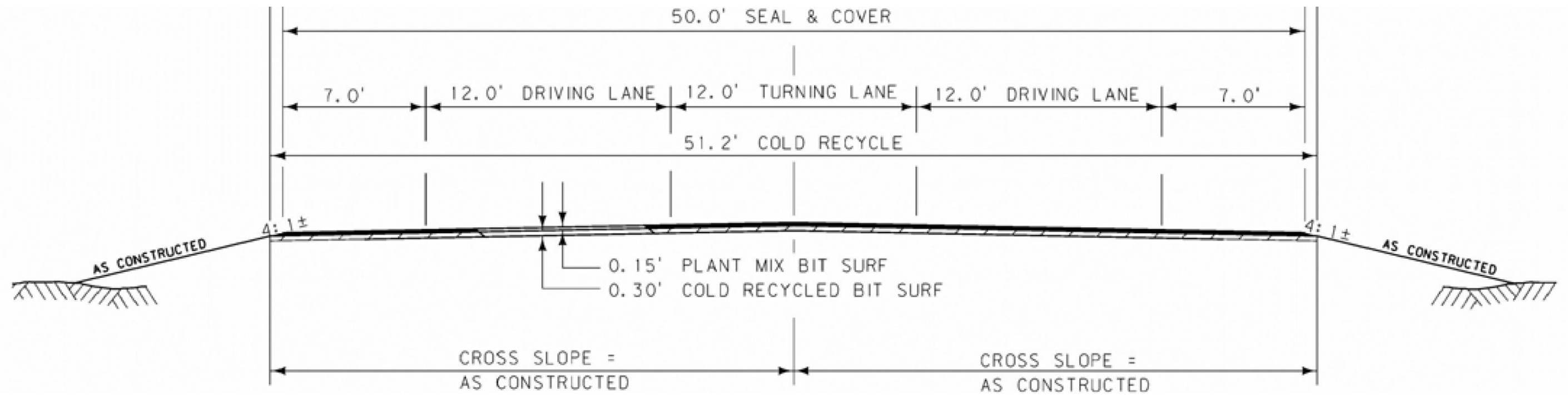
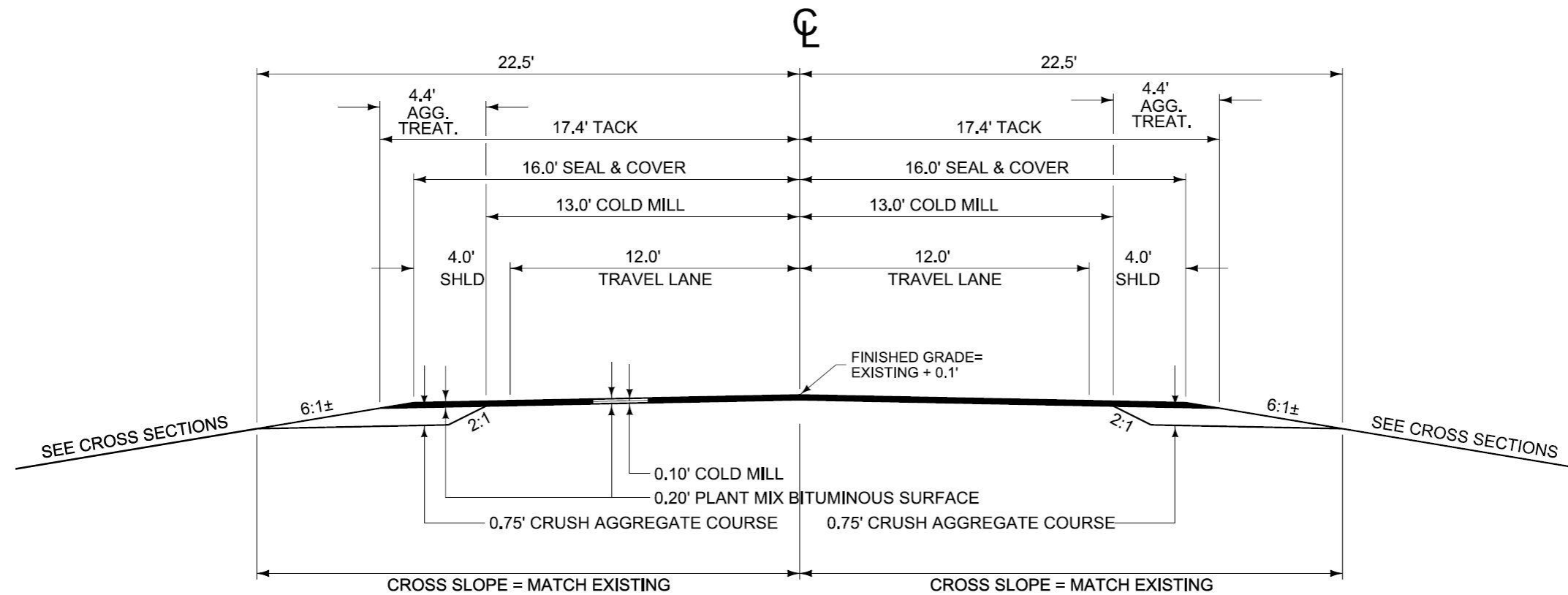

Exhibit 7-2 Engineered Overlay with Widening Section



This page intentionally left blank.

7.3 ENGINEERED OVERLAYS ON HIGH VS. LOW VOLUME ROADS

As discussed in the previous section and shown in Chapter 6, Exhibit 6-8, engineered overlays should not be done on pavement with structural distress in most cases. This approach holds true in most cases, but may not be the case on low volume roads. On low volume roads, a thick, engineered overlay may be able to “bridge over” and protect the underlying, distressed pavement.

An example of this is overlaying stripped PMS on a low volume road. Normally, overlaying stripped PMS is not advised because it moves the critical tensile stress upwards as shown in Chapter 4, Exhibit 4-1. Moving the critical strain higher in the pavement increases its magnitude and may result in a tensile crack.

The phenomenon above results in alligator cracking on high volume roads where repeated loadings cause a tensile crack to initiate at the PMS bottom. However, on low volume roads where the pavement is loaded relatively few times, a crack may not start. This lends itself to using thick overlays on low-volume roads to bridge structurally deficient pavement. Also, Grade S PMS is a high quality product with superior modulus, tensile strength, and durability, which allows it to bridge structurally deficient pavements more effectively.

7.4 ISOLATION AND LEVELING LIFTS

Isolation and leveling lifts can be utilized with engineered or routing PMS overlays to address ride, rutting, and/or crack sealant “bumping” issues.

7.4.1 Isolation Lifts

Crack sealant expands when overlaid with hot PMS. The expansion results in a noticeable bump on the overlay surface. An isolation lift can be used to mitigate this problem. An isolation lift is an additional 0.07 ft. PMS lift placed before the overlay. It is placed only within the travel lanes. Another benefit of an isolation lift is that it acts as a leveling course and results in a smoother post-construction ride.

On overlay projects greater than 0.15 ft., it may be desirable to reduce the overlay thickness to 0.15 ft. and to place the remaining thickness as an isolation lift. For example, for a 0.20 ft. overlay, the plans should specify a 0.15 ft. overlay and a 0.07 ft. isolation lift. This results in a total thickness of 0.22 ft. In this case, the isolation lift will provide extra structure and a better post-construction ride.

On engineered overlays where multiple lifts will be placed, isolation lifts are not necessary since the bottom lift will serve as an isolation lift. In addition, isolation lifts are 0.07 ft. which is thinner than the recommended lift thickness for $\frac{3}{4}$ in. plant mix (this is 2 to 3 times the nominal maximum aggregate size). Because of this, MDT requires a pneumatic rubber tire roller on the isolation lift to achieve compaction. Currently, there is a special provision that must be inserted in the plans package to outline the requirements and ensure adequate compaction is achieved.

An isolation lift is not required when paving directly over mastic. Mastic is a hot poured polymer modified asphalt binder with engineered aggregate used as a

Leveling is almost always necessary on single-lift overlay projects.

crack sealant. Mastic is typically identified by its relative flexibility even in cold temperatures and the aggregate in the sealant.

7.4.2 PMS Leveling Quantity

Leveling is almost always necessary on single-lift overlay projects. Leveling serves two purposes. First, it corrects surface defects such as dips, rutting, and otherwise out-of-section pavements. Second, it provides a smoother surface to place the overlay upon, resulting in a better post-construction ride.

Review of prior projects has shown that projects with adequate leveling quantities result in smoother overlays. The determination of the proper quantity should be made based on the condition of the existing roadway, discussions with District design and construction personnel, and guidance given in Exhibit 7-3.

Exhibit 7-3 shows the leveling quantities for post-construction rides that meet or exceed MDT's ride specification. If a decision is made to provide significantly less leveling than shown in Exhibit 7-3, ensure that the ride specification is excluded from that contract.

There are projects in which leveling is needed to address a specific defect, such as a dip or frost heave. On these projects, the defect location and its leveling quantity should be included in the plans. This ensures that the contractor places leveling in the correct location.

**Exhibit 7-3
Leveling Quantity Selection
Per 2 Lane Mile**

Crack Sealant & Rut Index Ride Index ²	Crack Sealant Present ¹		No Crack Sealant Present ¹	
	Rut ≥ 55 (0.25")	Rut < 55(0.25")	Rut ≥ 55(0.25")	Rut < 55(0.25")
Ride ≥ 76 ³	Isolation Lift	Isolation Lift	50 tons/mile	125 tons/mile
70 ≤ Ride < 76			50 -250 tons/mile ³	125-325 tons/mile ³
62 ≤ Ride < 70			250 -400 tons/mile ³	325-475 tons/mile ³
55 ≤ Ride < 62			Isolation Lift +75 tons/mile	Isolation Lift + 75 tons/mile
Ride < 55	Isolation Lift + 150 tons/mile	Isolation Lift + 225 tons/mile	Isolation Lift + 150 tons/mile	Isolation Lift + 225 tons/mile

¹ Include additional leveling to address any significant deformations on all roadways.

² Ride and Rut index is found in MDT's Annual Pavement Conditions and Treatments Report on the MDT Intranet, or contact the Pavement Management Unit.
Ride Index=100-(0.2667 X IRI)

³ Use Interpolation based on the ride index to determine leveling quantity.

7.5 ENGINEERING OVERLAY DESIGN

MDT's pavement rehabilitation design is based on the method presented in the 1993 Guide Part III, with modifications presented in this Pavement Design Manual. ((1), AASHTO, 1993)

Engineered overlays are designed using the following equation:

$$SN_{dgn} - SN_{eff} = SN_{ol}$$

Where:

SN_{dgn} = The structural number required for future traffic loading. Also known as SN_f (Structural number to carry future traffic) in the 1993 AASHTO Guide.

SN_{eff} = Existing pavement structural number.

SN_{ol} = The structural number deficiency between the existing pavement and that needed for the future pavement design. This is the amount of pavement structure that needs to be added with an overlay.

Generally, pavement rehabilitation design includes the following steps:

1. Determine if engineered overlay is feasible.
2. Determine existing pavement structural capacity (SN_{eff}).
3. Determine future pavement structural capacity (SN_{dgn}).
4. Determine additional pavement structure needed for design life (SN_{ol}).
5. Specify construction methods and materials.
6. Send pavement design and materials memorandum.

Step 1: Determine if engineered overlay is feasible

Choosing an engineered overlay project is heavily based on engineering judgment. Each pavement is unique, and there are usually a number of ways to rehabilitate a given pavement. The best method is one that meets the needs of the pavement designer, road designer, planning personnel, traveling public, safety, and the project budget. The designer should communicate with the road designer to ensure that the chosen rehabilitation method will fit within the broader project constraints.

Visually evaluating the pavement condition is the single most important input to making this decision. By evaluating the pavement distress, as well as the distress mechanisms that cause the distress, the designer determines whether the pavement distresses are functional or structural:

- **Functional distresses** are distresses that affect the traveling public, such as rough ride or low pavement friction. Those distresses, although a nuisance, can happen on a pavement that is structurally sufficient.

Pavements with functional distress tend to need less expensive surface treatments to restore the pavement serviceability and extend its design life. These projects are often referred to as pavement preservation.

- **Structural distresses** are an indication of inadequate pavement, such as deep pavement rutting and alligator cracking. Structural distress often needs deeper, more expensive rehabilitation in order to meet the desired design life.

Engineered overlays are the preferred method to rehabilitate pavements with functional distress, while pulverization should be utilized to treat structural distresses. Chapter 6, Exhibit 6-12 shows a flowchart to serve as a starting point for choosing a rehabilitation method. In addition to the issues defined in the flowchart, other issues that influence this decision include:

- **Traffic Volume.** There are times when heavy traffic volumes will influence the rehabilitation treatment decision and the design team may want a more conservative treatment than shown in the flowchart.

Conversely, on low volume roads, there may be a desire to be less conservative in the pavement design. This may mean an engineered solution that effectively “bridges” over a problem pavement rather than treats its structural distress directly.

- **Pavement Grade Raise:** Engineering overlays require pavement grade raise, usually on the order of 0.2 ft. to 0.5 ft. This needs to be considered since it may require roadside work and/or right-of-way take to accommodate the grade raise. Engineered overlays will also reduce the top width and should be discussed accordingly as sometimes this may not be a feasible option.

Other design issues that should be considered for engineered overlays include:

- The existing pavement has to be characterized using GPR, FWD, soil survey, and PMS cores since these designs rely on the underlying pavement structure.
- Reflection cracking and rutting need to be mitigated so that it does not reoccur on the finished pavement surface. Deep or unstable rutting should be addressed by removing and replacing the unstable PMS layer. Cold in-place recycling should be considered to reduce or delay the onset of reflection cracking. CIR material has a high air void content (~11-14%). The high air void level may retard reflective crack propagation.
- Do not expose base gravel.
- Ensure that milling is feasible. At least an inch of PMS should remain in place after milling to carry traffic during construction.
- Ensure that milling is not occurring on overly stripped PM: milling into stripped PMS may result in a rough milled surface. Generally, milling should only be done in material with an average stripping test grade greater than or equal to 1.2.
- Ensure that an overlay is not being placed directly on overly stripped PMS: placing PMS overlays on stripped plant mix (stripping grade less than or equal to 1) is not recommended. The underlying PMS may not have adequate strength to support the new overlay. *This may not hold*

**On low volume roads
overlaying stripped
plant mix may be
possible due to low
truck loading.**

true on low volume roads where overlaying stripped plant mix may be possible due to low truck loading.

- For overlay and widening projects, the widening sections CAC layer should extend to at least the depth of the existing roadway base course. This facilitates lateral pavement drainage and prevents “bathtub” pavement sections.

If milling and overlays are not recommended because of poor stripping analysis results, the project is likely a good candidate for pulverization.

Step 2: Determine existing pavement structural capacity (SN_{eff})

There are two different procedures for determining SN_{eff} : 1) Determine SN_{eff} from in-situ destructive testing results, and 2) Determine SN_{eff} from non-destructive testing results. These procedures are discussed further in the following sections.

7.5.1 Determine SN_{eff} From In-situ Destructive Testing

In the past, MDT has usually determined SN_{eff} using destructive methods to evaluate the existing pavement. Destructive methods refer to methods that damage the pavement, such as soil survey boring and PMS coring. The destructive testing information will help to characterize each pavement layer. SN_{eff} is calculated by summarizing the SN of each existing pavement layer.

7.5.2 Determining SN_{eff} from NDT information

This method of determining SN_{eff} is based on the information presented in 1993 AASHTO, Chapter 5.4 (pg. III-94 to III-102) (AASHTO, 1993), with adjustments that consider MDT experience. ((1), AASHTO, 1993)

In practice, the SN_{eff} should be calculated at each FWD testing location along the project length using a spreadsheet.

This method relies on NDT testing information only to determine SN_{eff} . NDT testing refers to FWD and GPR, which are discussed more thoroughly in **Error! Reference source not found.**14 of this Pavement Design Manual.

Additional information on NDT is provided in Chapter 14 and in the MDT Non-Destructive Testing Manual.

The first step in calculating SN_{eff} is to determine the E_p/M_R by using the nomograph in Exhibit 7-4. The nomograph requires the following variables:

$M_R * d_o / P$ and D

Where:

M_R = Uncorrected FWD back-calculated subgrade M_R . Uncorrected refers to not converting the back-calculated M_R to laboratory M_R (psi).

d_o = The FWD deflection directly under the load plate (mil).

P = The actual FWD load taken from FWD deflection data. Usually ranges from 8,500 to 9,500 lbs.

D = The total thickness of all pavement layers above the subgrade. This information should be determined as follows, in order of decreasing accuracy (in):

- GPR PMS depth and soil survey base course depth.
- Soil survey / core PMS depth and base course depth.
- TIS Roadlog PMS and base course depth.

Exhibit 7-4
Ep / Mr Nomograph

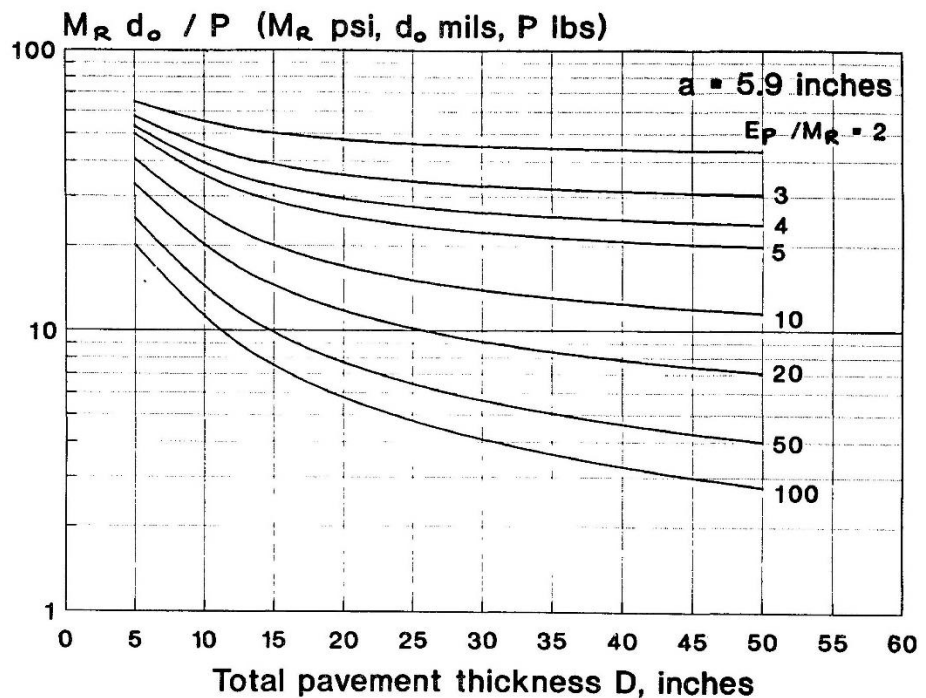

Figure 5.5. Determination of E_p/M_R

Source: From *The Guide for the Design of Pavement Structures*, Copyright 1993, by the American Association of State Highway and Transportation Officials, Washington, DC. Used by permission.

The second step is to calculate E_p (modulus of elasticity of the pavement):

$$E_p = E_p / M_R * M_R * C$$

Where:

E_p = Effective modulus of the pavement layers above the subgrade (psi).

C = Conversion factor to convert FWD back-calculated subgrade modulus to laboratory subgrade modulus. $C = 0.5$ for use in this equation (dimensionless).

SN_{eff} is calculated as follows:

$$SN_{eff} = 0.0045 * D * E_p^{(1/3)}$$

Where:

SN_{eff} = The structural number of the existing pavement

Step 3: Determine future pavement structural capacity (SN_{dgn})

Determine SN_{dgn} using the same procedure for new or reconstructed pavements outlined in Chapter 5.

Step 4: Determine additional pavement structure needed (SN_{ol})

Determine the pavement structure that needs to be added to the existing pavement to perform well over its anticipated design life. This is done using the following equation:

$$SN_{dgn} - SN_{eff} = SN_{ol}$$

Where:

SN_{dgn} = The structural number required for future traffic loading determined during Step #3.

SN_{eff} = The structural number of the existing pavement determined during Step #2.

SN_{ol} = The Structural Number deficiency between the existing pavement and that needed for the future pavement design. This is the amount of pavement structure that needs to be added during pavement rehabilitation.

Additional pavement structure, SN_{ol} , is accomplished by either adding a supplementary pavement lift thereby thickening the existing plant mix, or improving the integrity of the existing plant mix. Additional plant mix thickness is typically achieved with a plant mix surfacing overlay. Plant mix integrity improvement is accomplished by either removing the poor performing material

with a milling operation and placing new plant mix or, improving the existing plant mix with an in-place recycling operation.

7.5.3 Completing the Widening Section Design

The pavement widening section design is usually designed similarly to a new pavement. Follow the steps in Chapter 5 subsection *Error! Reference source not found.* to design the widening section.

Also, consider the following when designing widening sections:

- Consider using the material from the rehabilitation section within the widening section. For example, pavement millings can be blended with virgin CAC to provide CAC for the widening section.
- The widening sections base course should extend to or below the depth of the existing gravel section. This facilitates drainage and avoids designing a “bathtub” pavement section.
- The designer should approach widening sections with caution. If the widening section will be a pavement shoulder with little or no traffic, consider using a thinner PMS layer upon the widening section. Consider the following guidelines:
 - The minimum shoulder thickness should be 0.30 ft. PMS in order to provide depth for future milling operations. (Shoulder less than 0.30 ft. may be considered on very narrow widening sections or low-volume roads.)
 - The designer should not do this on Interstate pavements, pavements where future traffic lanes may be placed on the shoulder, or shoulders that may become traveled upon if turning lanes are installed in the future.
 - Consider constructability when designing widening section PMS thickness. Usually, the engineered overlay is placed over the entire road surface after the widening CAC is placed (
 - Exhibit 7-2).

Where more than one PMS lift is placed on the widening section, the bottom lifts are placed flush with the existing surface.

7.5.4 Spreadsheet Solution for Calculating SN_{eff} , SN_{dgn} , and SN_{ol}

MDT has developed a spreadsheet for use in calculating the structural numbers needed for engineered overlay design. Exhibit 7-5 shows the spreadsheet with details on its use. The spreadsheet can be found in the Surfacing Design Share Drive.

Exhibit 7-5 Spreadsheet for calculating SN_{eff} , SN_{des} , SN_{ol} , and Engineered Overlay Thickness

20-year design ESAL 313,900 Average 20-year Daily ESAL 43																						50% Reliability			95% reliability				
ADAP_ROUTE	ADAP_DATE	ADAP_KM	ADAP_LOAD	ADAP_DEFL1	DEF_L2	DEF_L3	DEF_L4	DEF_L5	DEF_L6	ADAP_DEFL7	ADAP_SURF_THICK	ADAP_SURF_MOD	ADAP_BASE_THICK	ADAP_BASE_MOD	ADAP_SBGR_MOD	$Mr = (.24 * P) / (dr * R)$	ADAP Subgrade lab mod	$Mr * do / P$	Total pvmt thickness (in)	E_p / M_r	E_p (psi)	S_{neff}	S_{ndes}	SN dif	Overlay thick (in)	S_{ndes}	SN dif	Overlay thick (in)	RP
28	ADAP_DATE	114.8	11.33	14	12.2	10.7	8.3	6.9	4.1	2.6	5.3	1,171,783	12	42,900	9,600	21,540	4,800	15	17	18.5	88,800	3.47	2.3	-1.17	-2.86	3.4	-0.07	-0.18	71.29
28	9/21/20 09 0:00	114.9	11.55	14.3	12.5	11	8.8	7.4	5	3.5	5.3	910,651	12	64,600	10,900	16,453	5,450	17	17	12.5	68,125	3.18	2.3	-0.88	-2.15	3.26	0.08	0.2	71.35
28	9/21/20 09 0:00	115	11.77	17.1	14	11.7	8.9	7.1	4.6	3.2	5.3	518,831	12	48,800	12,000	18,565	6,000	23	17	8	48,000	2.83	2.1	-0.73	-1.78	3.04	0.21	0.51	71.42
28	9/21/20 09 0:00	115.1	11.84	14.6	12.3	10.4	7.9	6.2	3.5	2.3	5.3	869,624	12	43,400	10,900	26,195	5,450	18	17	12.5	68,125	3.18	2.3	-0.88	-2.15	3.26	0.08	0.2	71.48

Blue Text refers to items input by the spreadsheet user, Black text refers to variables calculated by the spreadsheet. Note that ADAP inputs are put into the spreadsheet by cut and pasting NDT data from the project spreadsheets provided by the NDT unit.

20-year design ESAL: 20-year design ESAL provided by the Traffic Data Unit for the subject project
 Average 20-year Daily ESAL: Calculated based upon 20-year design ESAL / (365 days/year * 20 years)
 ADAP_ROUTE, ADAP_DATE, ADAP_KM – The Department Route, Date, and Location (Kilometer Post) where FWD test was done

ADAP_Load – FWD load magnitude (kips)
 ADAP_DEFL1 = The deflection directly under the load plate (d_o)
 DEFL2, DEFL3, DEFL4, DEFL5, DEFL6, DEFL7 – FWD deflections for information only
 ADAP_SURF_THICK, ADAP_BASE_THICK – Usually GPR calculated PMS thickness and TIS Roadlog CAC Thickness
 ADAP_SURF_MOD, ADAP_BASE_MOD, ADAP_SBGR_MOD- FWD back-calculated layer moduli
 $Mr = (.24 * P) / (dr * R)$ = For information only – 1993 AASHTO equation 5.23. This is subgrade M_R calculated based on FWD parameters only. P = FWD load (lbs), dr = DEFL7 (in), R= distance from load to DEFL7 (48")

ADAP Subgrade lab mod = Uncorrected FWD back-calculated subgrade $M_R * 0.5$
 $Mr * do / P$ = Used in nomograph (Exhibit 7-4) to calculate $(E_p / M_r)_{Nomograph}$ Where $M_r = ADAP_SBGR_MOD$ (psi), $do = ADAP_DEFL1$ (mils), and $P = ADAP_Load$ (lbs)
 Total pvmt thickness: $ADAP_SURF_THICK + ADAP_BASE_THICK$
 E_p / M_r : $(E_p / M_r)_{Nomograph}$ calculated based on Exhibit 7-4 and $Mr * do / P$ and Total pvmt thickness
 E_p (psi): $E_p / M_r * ADAP_Subgrade\ lab\ mod$
 $S_{neff} = 0.0045 * (Total\ pvmt\ thickness) * E_p^{1/3}$
 50% Reliability and 90% Reliability S_{ndes} , SN dif, Overlay thick (in): 50% and 90% reliability refers to using 50% and 90% reliability in the AASHTO pavement design equation, respectively. $S_{ndes} = SN_{des}$ calculated from 20-year design ESAL and ADAP Subgrade lab mod, SN dif = $SN_{ol} = SN_{des} - S_{neff}$, Overlay thick = $SN_{ol} / 0.41$ where 0.41 is the structural coefficient for new PMS
RP: is the RP that the FWD test was done at. Converted by $ADAP_KM * 0.621$

This page intentionally left blank.

Step 5: Specify construction methods and materials

The materials for the designed pavement need to be specified by using the same procedure for new or reconstructed pavements. This process is outlined in **Error! Reference source not found.***Error! Reference source not found.*

Step 6: Send pavement design and materials memorandum

A surfacing design memorandum should be developed and sent to the appropriate staff as described in Chapter 5 and Appendix B.

Verify that the correct distribution list has been used. After completing the surfacing design memorandum in Microsoft Word, save the .docx file to the Surfacing Design Unit shared drive. Also save the file as *.*.pdf file to be uploaded to the document management system. Appendix C outlines the steps to name the file and upload the document. Projects designed by a consultant will be handled within the corresponding activity in the appropriate flowchart.

Once the memorandum has been submitted for distribution and saved, the EPS activity may be carded off.

7.6 REFERENCES

1. AASHTO. *Guide for Design of Pavement Structures*. AASHTO, Washington D.C., 1993.

MONTANA DEPARTMENT OF TRANSPORTATION

PAVEMENT DESIGN MANUAL

Chapter 8

Gravel Road Design

November 2018



Contents

CHAPTER 8 GRAVEL ROAD DESIGN.....	8-1
8.1 Introduction.....	8-1
8.2 Gravel Road Design.....	8-1
8.2.1 Detour Design.....	8-2
8.3 References.....	8-2



Chapter 8

Gravel Road Design

8.1 INTRODUCTION

Some MDT roadways are gravel and require specific design procedures associated with gravel road design. This chapter provides an overview of the gravel road thickness design and information on design detours.

8.2 GRAVEL ROAD DESIGN

MDT typically uses Type B Grade 3 Crushed Top Surfacing for gravel roads. This material is described in Table 701-11 of the 2014 Standard Specifications (1). Exhibit 8-1 should be used to determine gravel road thickness.

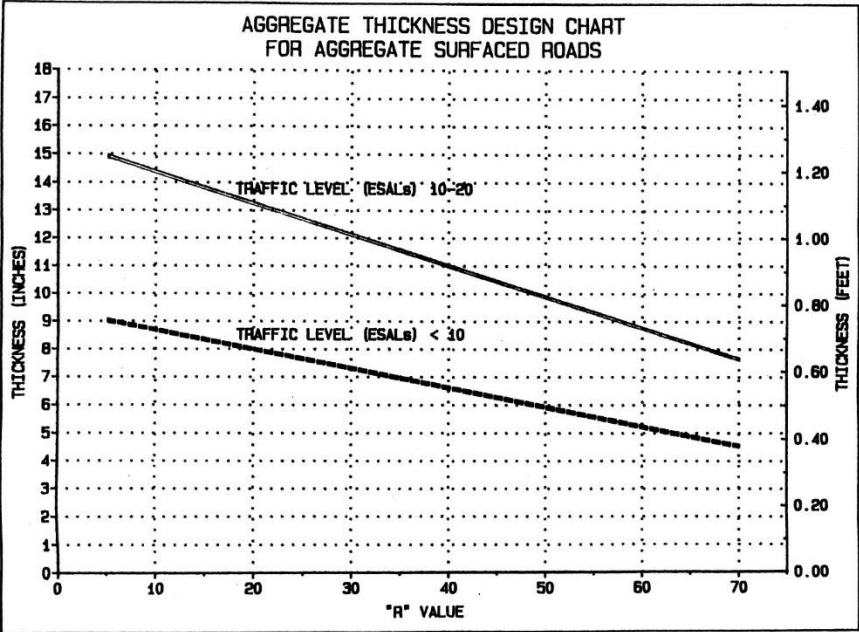

Exhibit 8-1
Gravel Road Thickness Design
Graph

8.2.1 Detour Design

Exhibit 8-2 is from the 2016 *MDT Road Design Manual* and is intended as a guide for appropriate surfacing design for a detour (2).

**Exhibit 8-2
Guidelines for Selection of
Detour Surfacing**

Current ADT	Duration of Detour Operation			
	< 5 Days	5 - 30 Days	31 Days - 3 Months	> 3 Months
< 500	Gravel	Gravel	Treated Gravel	Treated Gravel
500 - 1499	Gravel	Treated Gravel	Treated Gravel	Plant Mix Surfacing (PMS)
1500 - 6000	Treated Gravel	Treated Gravel	PMS	PMS
> 6000	Treated Gravel	PMS	PMS	PMS

Notes:

Gravel is untreated crushed aggregate course (CAC).

Treated gravel is CAC that has an aggregate treatment applied to the riding surface to help to control dust and add durability.

Plant Mix Surfacing (PMS) is a paved surface on top of a CAC base.

8.3 REFERENCES

1. MDT. *Standard Specifications for Road and Bridge Construction" 2014 Edition, Adopted by the Montana Department of Transportation and the Montana Transportation Commission*. MDT, Helena, MT, 2014.
2. MDT. *Road Design Manual*. MDT, Helena, MT, 2016.

MONTANA DEPARTMENT OF TRANSPORTATION

PAVEMENT DESIGN MANUAL

Chapter 9

New and Reconstructed Rigid
Pavement Design

November 2018



Contents

CHAPTER 9 NEW AND RECONSTRUCTED RIGID PAVEMENT DESIGN.....	9-1
9.1 Introduction.....	9-1
9.2 Concrete Pavement Design Details.....	9-1
9.3 References.....	9-2



Chapter 9

New and Reconstructed Rigid Pavement Design

9.1 INTRODUCTION

MDT encourages the use of Portland Cement Concrete Pavement (PCCP) where it is cost effective. Usually, PCCP has a higher initial construction cost than asphalt pavements. However, PCCP life cycle cost is usually less due to its longer design life and decreased future maintenance. This is particularly true on roadways with relatively thick PMS sections. PCCP should also be considered on urban roadways and intersections where reoccurring asphalt treatments will be a nuisance to the traveling public.

9.2 CONCRETE PAVEMENT DESIGN DETAILS

MDT uses jointed plain concrete pavement (JPCP) exclusively. Typically, MDT uses a two-layer concrete pavement consisting of doweled JPCP underlaid with a crushed aggregate course subbase. The details for jointed plain concrete are now available in MDT's Detailed Drawings at the [following website \(1\)](#):

[MDT Detailed Drawings](#)

Additional details and joint plans will be required in non-standard configurations such as roundabouts.

MDT has used continuously reinforced concrete pavement (CRCP) under railroad overpasses to minimize future maintenance near the railroad structure. In these cases, the highway was in a wet environment and consisted of a vertical sag curve under the railroad overpass. Exhibit 9-1 shows MDT's preferred design parameters.

**Exhibit 9-1
Concrete Pavement
Design Parameters**

Design Parameter	Criteria
Design Life	30 years minimum, 40 years where appropriate
Pavement Design Method	1993 AASHTO, PCAPave, Darwin ME. Consider designing based on an average of these methods. The AASHTO method is often overly conservative.
Rigid Design ESALs	Request Rigid ESALs from the Traffic Section. Normally, Flexible ESALs are provided by the Traffic Section because most projects incorporate bituminous pavements. Rigid ESALs are typically 40% higher than Flexible ESALs because rigid pavements are much stiffer than bituminous pavements. Base layers under rigid pavements do not experience high levels of stress or strain as base layers under flexible pavements and are not subject to as much of the load.
PCCP Thickness	0.65' minimum
Subbase Thickness	0.50' minimum
Concrete Type*	Class PAVE
Transverse Joints	Non-skewed joints reinforced with corrosion resistant dowel bars. Joints consist of 1/8" saw cuts with crack sealant.
Surface Texture	As per MDT Standard Specifications
Slab Length	12' minimum
Longitudinal joints	Reinforced with deformed rebar joints - 1/8" saw cuts with crack sealant or construction joint
Shoulders	Urban sections – Concrete Rural sections – PMS with 1' widened concrete slab along driving lane. PMS shoulders tend to have significant maintenance issues over time. Settlement and cracking occur frequently. Consider using concrete to construct shoulders whenever possible.

9.3 REFERENCES

1. MDT. MDT Detailed Drawings. Website:
http://www.mdt.mt.gov/business/contracting/detailed_drawings.shtml

MONTANA DEPARTMENT OF TRANSPORTATION

PAVEMENT DESIGN MANUAL

Chapter 10

Rigid Pavement Rehabilitation

November 2018



Contents

CHAPTER 10 RIGID PAVEMENT REHABILITATION...10-1

10.1 Introduction.....	10-1
10.2 Minor Rehabilitation	10-1
10.3 Major Rehabilitation.....	10-1
10.4 Other Rehabilitation Treatments.....	10-2
10.5 References	10-2



Chapter 10

Rigid Pavement Rehabilitation

10.1 INTRODUCTION

Chapter 10 provides an overview of rigid pavement rehabilitation. This includes guidance for minor rehabilitation and major rehabilitation. Information on other rehabilitation treatments is also provided.

10.2 MINOR REHABILITATION

The first post-construction treatment for concrete pavements is to perform a minor rehabilitation, which typically consists of minor slab replacement, diamond grind, and joint resealing. Depending on concrete thickness, a concrete pavement may allow for multiple minor rehabilitations within its overall life span.

Another minor rehabilitation treatment for concrete pavements is to perform a diamond grind and then to place a plant mix seal on the concrete.

A diamond grind with a plant mix seal on the concrete was an effective method used in the Glendive District.

10.3 MAJOR REHABILITATION

The next level of post-construction treatment for concrete pavements is to perform a major rehabilitation, which typically consists of slab replacement, dowel bar retrofit, diamond grind and joint resealing. Many of the concrete pavements in Montana were initially constructed during the 1960s using aggregate interlock between slabs and therefore, do not have dowel bars or reinforcement. An effective rehabilitation strategy is to saw cut in dowel bars and grout them in place. Faulting is also corrected with the diamond grinding.

The final level of major rehabilitation treatment for concrete pavements is to perform a crack and seat and then to apply a Hot Mix Asphalt (HMA) overlay. The Portland Cement Concrete Pavement (PCCP) should be cracked and seated prior to placing an HMA in order to minimize reflective cracking by reducing the size of the PCCP slab. When cracked and seated properly, reflective cracking is essentially eliminated.

The PCCP should be cracked at 24 in. intervals to create a uniform pattern of cracking. Once the PCCP is cracked, it should be seated with a rubber tired roller weighing at least 35 tons. The seating by the roller pushes down the PCCP pieces and provides an excellent base for the asphalt overlay to be placed directly on. The procedure for the crack and seat should be:

1. Crack the PCCP slabs.
2. Seat the cracked pieces.
3. Remove and repair any soft spots.
4. Sweep the project clean.
5. Apply a tack coat.
6. Place an asphalt leveling course.
7. Place the asphalt overlay.

Crack and seat is a treatment more suitable for the rural environment. When used on the east coast in the urban environment, the process of cracking the existing PCCP broke old water mains and cracked windows and walls in homes adjacent to the roadway.

10.4 OTHER REHABILITATION TREATMENTS

White topping can be used effectively on both existing plant mix and concrete pavements. In the past, MDT has successfully used this in urban areas with existing thick pavement sections. This was primarily done on high average annual daily traffic (AADT) routes with bad rutting. This would be considered a major rehabilitation treatment. When placed on concrete, overlays are divided into two categories, bonded or un-bonded. The American Concrete Paving Association (ACPA) may be a helpful resource that delineates the different overlay types and can provide other detailed information relevant to this section.

10.5 REFERENCES

No references were identified for this chapter.

MONTANA DEPARTMENT OF TRANSPORTATION

PAVEMENT DESIGN MANUAL

Chapter 11

Pavement Preservation & Scheduled Treatments

November 2018



Contents

CHAPTER 11 PAVEMENT PRESERVATION & SCHEDULED TREATMENTS	11-1
11.1 Introduction	11-1
11.2 Surface Treatments.....	11-1
11.2.1 Diamond Grinding	11-5
11.2.2 Micro Milling	11-5
11.2.3 Fog Seal	11-5
11.2.4 Seal and Cover (Chip Seal).....	11-6
11.2.5 Scrub Seal.....	11-6
11.2.6 Texas Underseal.....	11-7
11.2.7 Paving Fabric (Geosynthetic).....	11-7
11.2.8 Slurry Seal.....	11-7
11.2.9 Micro Surfacing.....	11-8
11.2.10 Plant Mix Seal.....	11-8
11.2.11 3/8 In. Grade S Plant Mix Surfacing	11-9
11.2.12 Cape Seal.....	11-9
11.2.13 Inverted Cape Seal.....	11-9
11.2.14 Fiber Reinforced Plant Mix	11-10
11.2.15 Hot-In-Place Recycling (HIR).....	11-10
11.2.16 Cold-In-Place Recycling (CIR)	11-10
11.2.17 Concrete Overlays (White-topping).....	11-11
11.3 Resources.....	11-11
11.4 References	11-12



Chapter 11

Pavement Preservation & Scheduled Treatments

11.1 INTRODUCTION

The intent of pavement preservation projects is to extend the useful life of pavements based on an observed pavement distress rather than on a scheduled basis. The surfacing designer should prepare for the Preliminary Field Review prior to the review by examining the project's ride and rut data. In addition, the designer should have a knowledge of the existing typical section thickness and the time and type of the last treatment. The designer can review historical project files and as-built plans, and consult with the District Materials Labs to obtain existing mix and source information.

11.2 SURFACE TREATMENTS

MDT uses several types of surfacing treatments for pavement preservation and new construction. This document is focused on lighter surface treatments which are usually identified as 'pavement preservation,' and fall under maintenance, pavement preservation or minor rehabilitation for the MDT. The intent of pavement preservation is to keep good pavement sections in good conditions. This is done by sealing the pavement from moisture intrusion, improving surface smoothness, crack mitigating, and rut correction. New construction projects often incorporate the same surfacing treatments over the top of new plant mix surfacing (PMS). The most common example of this is a seal and cover (chip seal) over plant mix surfacing. This is intended to seal the dense graded Grade S plant mix surfacing. Grade S is typically more resistant to rutting than mixes of the past, such as Grade B or D Marshall mixes; however, it is more susceptible to stripping because of the lower relative oil content. Though not all of the treatments noted in this document are frequently used in Montana, there are applications where each will provide a viable, cost effective surface treatment. The treatments are generally

listed in order from light to heavy. This typically corresponds to a traditional pavement condition curve as shown below in Exhibit 11-1 from LA County (1). As you move right and down on the curve, the treatment types go from lighter to heavier.

**Exhibit 11-1
Pavement Condition
Chart (1)**

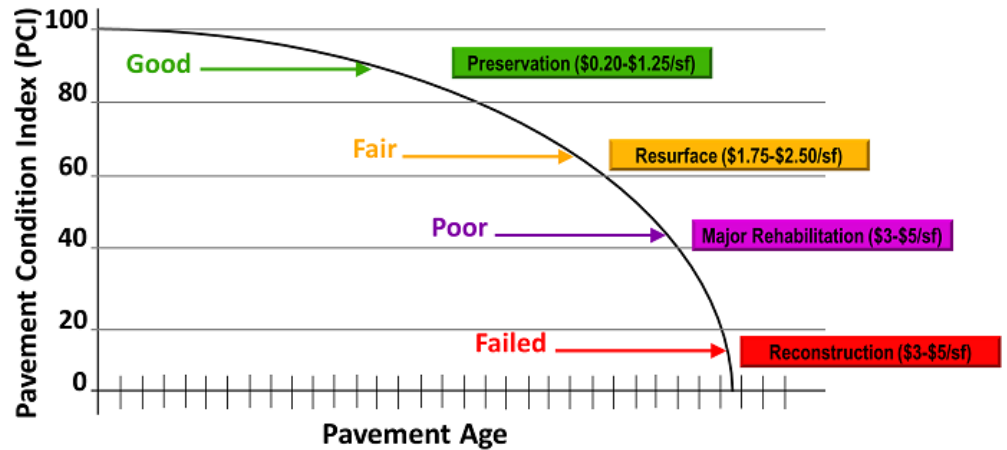

Exhibit 11-2 gives additional guidance on surfacing treatment selection.

Exhibit 11-2 PMS Surface Treatment Selection Guidelines

Surface Treatment	Treatment Thickness	Traffic Level	Stop-and-go traffic	High Traffic Speed (>55mph)	Heavy Snow-plowing	Other Considerations
Type I Chip Seal³	3/8" ^{1, 2}	<10,000 ADT	No	Yes	No	A chip seal should not be placed on rutted roadways with ruts greater than 0.25".
Type II Chip Seal³	3/8-1/2" ^{1, 2}	>10,000 ADT	Yes	Yes	Yes	This treatment can be considered on roads with <10,000 ADT where previous chip seals have performed poorly (i.e. wear within wheel paths.). This treatment should not be placed on rutted roadways with ruts greater than 0.25".
3/8" Grade S	0.10'	N/A	Yes	No ⁴	Yes	Placement of this treatment on existing curb & gutter sections requires taper milling and ADA upgrades. Consider where past chip seals have not performed well (i.e. wear within wheel paths). This treatment can be used to correct rutted pavement.
Plant Mix Seal	0.06' ²	N/A	No	No ⁴	No	Placement of this treatment on existing curb & gutter sections does not require taper milling and ADA upgrades. This treatment should be used where pavement noise is an issue. This treatment should not be placed on rutted pavement.
Micro surfacing	3/8" ^{1, 2}	N/A	No	Yes	No	This treatment is not normally placed on new PMS. This treatment can be used to correct rutting on pavements in good condition. This treatment can be used to fill stable ruts up to 3/4" deep. Ride quality and index should be considered when selecting micro surfacing. For lower ride values (less than 75 IRI), micro surfacing may not improve the ride quality and may not be the best treatment if ride is the primary consideration. After the micro surfacing is placed, the PvMS Condition Report may still trigger a thin overlay as a recommended treatment.

¹ For information only, treatment thickness is not shown in Plans.

² Does provide structure to pavement, do not include as part of PMS structural layer.

³ Type I and Type II chips are Grade 4A and Grade 2A materials, respectively, described in Table 701-12 of the 2006 Standard Specifications.

⁴ Consideration can be given to using 3/8" Grade S and Plant Mix Seals on high traffic speed roadways if project specific circumstances warrant their use.

This page intentionally left blank.

11.2.1 Diamond Grinding

Diamond grinding is generally used as a pavement preservation treatment on concrete pavements. With bituminous surfacing, grinding is typically used by contractors to correct isolated smoothness issues or eliminate bumps at bridge ends. In Montana, diamond grinding is not specified as a pavement preservation technique for asphaltic concrete. Diamond grinding is typically feasible with faulting up to ½ in. Ride improvement is the typical reason to perform a diamond grind. However, ride is less of an issue on lower speed urban routes where road noise may be more of a nuisance. Diamond grinding will reduce road noise and improve friction. It also eliminates ruts caused by abrasion and studded tire wear.

11.2.2 Micro Milling

Micro milling removes a top portion of the pavement surface to eliminate ruts and improve ride. It is done using a milling machine, which uses a large drum with carbide or diamond teeth to remove the asphalt. Micro milling uses more cutting teeth than conventional cold milling. This process does not seal the existing pavement and should be used with another surface treatment intended to prevent moisture intrusion. MDT has used this process sparingly in the past in conjunction with a chip seal. Contractors have used this process on existing pavements prior to micro surfacing and overlays to improve ride and increase incentives. On high speed facilities with lofty expectations for surface smoothness, this process should be used in conjunction with micro surfacing or an asphalt overlay, rather than with a chip seal alone. This process has been used successfully on MDT low speed urban routes with no overlay.

Micro milling has been used successfully on MDT low speed urban routes with no overlay.

11.2.3 Fog Seal

Fog seals are a surface treatment typically applied to a new chip seal or plant mix surfacing. MDT allows the use of SS-1, SS-1h, CSS-1 and CSS-1h emulsions. At one time, MDT applied fog seals to new plant mix to seal the “dry” Grade S plant mix and prevent overabsorption of the chip oil, CRS-2P. The fog seal also creates a more uniform application rate for chip seals applied to surfaces with variable characteristics. Bike and pedestrian paths are often fog sealed as a preservation technique when a pavement preservation project is being constructed on an adjacent roadway. 3/8 in. Grade S surfacing courses with no planned chip seal are generally not fog sealed. Rumble strips are usually cut near pavement joints with lower density. A fog seal will help but not eliminate the vulnerability of the plant mix in these areas.

In recent years, MDT has been experimenting with fog seals over new chips seals. The overall goal is to improve chip retention. The fog seal membrane is quickly worn through at the surface. However, the lower lying emulsion forms a matrix which is thought to reduce chip loss. They do eliminate early fly rock and chip loss, which can be a significant nuisance to the public. Contractors prefer applying fog seals because they help a marginal chip seal survive past the chip seal warranty period (early December). The black surface absorbs more heat which aids in the curing of the chip seal. Warmer curing is advantageous to chip seals placed later in the summer when temperatures are lower. The black surface also

provides a good contrast to striping. MDT Maintenance often uses fog seals on chip seals. However, the use varies widely across the state. There is no cost/benefit information for fog seals available currently. Shaded corridors, mountain passes, and roads with heavy snow plowing are expected to benefit from a fog seal placed over the chip seal.

11.2.4 Seal and Cover (Chip Seal)

Chip seals are MDT's preferred surface treatment for new plant mix surfacing and pavement preservation. Chip seals have helped MDT roads combat moisture infiltration, one of the worst problems that pavements face. Super-pave plant mix is particularly susceptible to stripping and benefits greatly from being chip sealed soon after construction. MDT generally specifies Type 1 cover material, reserving Type 2 chips for high volume roads or urban applications. Type 2 chips are cleaner and often need to be washed during crushing, which leads to a higher cost. MDT modified the gradation bands in around 2016, creating cover Type 3. Type 3 is a ½ in. chip which is also cleaner with less intermediate sized rock. These chips generally have a higher oil demand. This type has been used sparingly, typically reserved for mountain passes and areas with softer rock (higher LA wear) where traffic wears through the chip seals more quickly. The oil specified is CRS-2P, which may be 2% latex or polymer modified. CRS-2P is flexible even after curing. The oil tends to soften and reactivate the first couple of seasons, which is highly effective at keeping surfaces and cracking sealed for multiple seasons. MDT has been experimenting with the more expensive CHFERS-2P. (HF designates "High Float.") CHFERS-2P is marketed to have better early chip retention and which can shorten the need for traffic control and reduce fly rock and early chip loss. Maintenance forces have also been using CHFERS-2P with some success. There is no cost/benefit information for CHFERS-2P available currently. A chip seal will increase the surface roughness initially until the aggregate is polished by traffic over time. Chip seals are best reserved for roads with a Rut Index > 60 or rut depths < 0.20 in. (classified as "Good") by MDT's pavement management system. When rutting becomes more pronounced, other treatments can be selected to improve rutting, though usually at a significantly higher cost.

11.2.5 Scrub Seal

A scrub seal is similar to a chip seal with a few minor differences. The scrub seal draws its name from an apparatus towed behind the emulsion distributor called the "broom." The "broom" has a series of broom heads which push a wave of emulsion, allowing more emulsion to fill cracks. The cracks are cleaned out in advance of the process. Although CRS-2P or other oils may be used, a proprietary "rejuvenating" emulsion called PASS-CR is marketed by suppliers for this process. This emulsion is marketed to soften and bond to the walls of the cleaned cracks; and the process is marketed to compete with a standard crack seal/seal and cover project.

MDT has nominated a few scrub seal projects to evaluate the cost and benefit. With a higher application rate, scrub seals should not be used where steep grades, cross-slopes, heavy rutting, or tricky geometric constraints can cause the emulsion to run out of the cracks before the chip spreader can cover the surface. Scrub seals

usually would not be utilized on MDT's Interstate, National Highway or Primary routes because a mill/fill will likely occur before enough cracking develops to make the road a scrub seal candidate. The Surfacing Design Unit is evaluating scrub seals primarily for the Urban Pavement Preservation program where funding is much more limited, and roads have deteriorated beyond the ideal time for a chip seal.

11.2.6 Texas Underseal

Texas underseal is an application of a chip seal followed by an asphalt overlay. The primary goal is to seal up the underlying pavement and base. The more flexible interlayer has been thought to delay reflective cracking as well. If the top lift of the pavement is milled off, stripped plant mix may be rejuvenated by the fresh CRS-2P. MDT has scoped a few projects utilizing Texas underseals. "Under Scrub Seals" have also been nominated on Urban Pavement Preservation projects limited to a 0.20 ft. HMA mill and fill where significant cracking may provide a reduced service life. In addition to the underseal, the surfacing can consist of $\frac{3}{4}$ in. Grade S and a chip seal over the top of the overlay, or $\frac{3}{8}$ in. Grade S (with no chip seal). Bleeding through the plant mix and rutting can occur when too much oil is used in the system, which makes the mix design and placement critical. Additional information can be found in the FHWA/TxDOT *Guidelines for the Use of Underseals as a Pavement Moisture Barrier* (2).

11.2.7 Paving Fabric (Geosynthetic)

Similar to a Texas underseal, nonwoven and woven geosynthetics have been used as an interlayer in the bituminous pavement to enhance the properties of the plant mix surfacing. The fabric is placed immediately over an emulsion or asphalt binder, and then paved over. The primary functions are to provide tensile reinforcement and to create a moisture barrier near the top of the pavement structure. They have also been touted to mitigate reflective cracking. The industry also markets geosynthetics as a method to thin asphalt lifts. One concern with paving fabrics is the effect on milling operations and the reuse of the pavement millings as recycled asphalt pavement (RAP) in future mixes. MDT has constructed a few pavements with paving fabrics, and the City of Great Falls has used it on numerous occasions.

11.2.8 Slurry Seal

A slurry seal is described by the International Slurry Surfacing Association's (ISSA) performance guideline A105 as a mixture of emulsified asphalt, mineral aggregate, water, and additives applied as a homogeneous mat which adheres firmly to the prepared surface and provides a skid resistant texture (3). Similar to micro surfacing in nature with one exception, slurry seal emulsions are not typically polymer modified. Slurry seals are often used on parking lots and would be appropriate for rest areas. They have been used in Montana; however, their use is rare. Slurry seals usually can incorporate ISSA Type I (#8 mesh), Type II (#4 mesh), or Type III ($\frac{3}{8}$ in. mesh) aggregate. For highways, micro surfacing is the preferred surface treatment. Placed in thin, stiff, brittle lifts, any cracking will reflect through within the first year.

11.2.9 Micro Surfacing

ISSA A143 describes micro surfacing as a mixture of polymer-modified emulsified asphalt, mineral aggregate, water, and additives capable of performing in variable thickness cross-sections, such as ruts, scratch courses and milled surfaces (4). After curing and initial traffic consolidation, it should resist further compaction and provide a skid resistant texture. MDT typically specifies Type III aggregate (a 3/8 in. dense graded aggregate). This aggregate has a similar gradation band to 3/8 in. plant mix, or the crushed fine aggregate often used in 3/4 in. Grade S plant mix. Ruts are typically filled with a rut box (half a travel lane wide), a scratch course (full travel lane wide), or both. A finish course is applied after the lower courses. Unlike the softer CRS-2P used with chip seals, micro surfacing uses CQS-1h. This results in a stiff, brittle surfacing which does provide added pavement structure. Any added structure is not used to satisfy any pavement structural design requirements. Though micro surfacing provides a quiet, smooth driving surface, achieving significant ride improvement is difficult. MDT has incorporated a ride specification primarily to ensure the existing ride quality is maintained. One of the primary reasons that micro surfacing is specified is for the improvement of rutting on roads. Past micro surfacing projects have typically reduced the rutting by 50-70%. Using an emulsion consisting of about 1/3 of water, the initial volume loss during the break of the mix and the initial trafficking in the wheel paths limits the amount of rut improvement. Micro surfacing has roughly 10-12% voids, which is 2-3 times higher than plant mix surfacing. MDT has specified rut filling, in addition to scratch and surface courses, to attempt to increase the rut improvement. Micro surfacing has also been used as an economical way to fill in rumble strips. Past projects have held up well to snow plow activity. Crack sealing may be performed either prior to or after micro surfacing. Crack sealant placed prior to micro surfacing can cause construction related problems when tack is used (sticking to equipment, pickup, etc.). Crack sealing prior to micro surfacing provides a more effective method of sealing the pavement structure. Crack sealing after micro surfacing may be preferred; however, it must be postponed until the following construction season.

11.2.10 Plant Mix Seal

Plant Mix Seals are often referred to as Open Graded Friction Course (OGFC). As the name implies, the compacted mix uses low fines (0-5% minus-200 mesh) to create a more permeable pavement to allow moisture to flow through the pavement. They are typically quieter than dense graded mixes such as 3/8 in. Grade S which is now used more commonly on MDT facilities. However, these have had mixed reviews from Department staff. The relatively high oil content (~6%) results in an expensive surface treatment. Some delamination problems have been reported in freeze-thaw climates such as MDT. The Glendive District used a plant mix seal over PCCP on I-94, which has performed remarkably well. Urban areas are likely the most appropriate candidates for a plant mix seal. If used in curb and gutter typical sections, the plant mix seal should lie above the flow line of the pavement. Pavement Interactive provides an additional description of OGFCs (5).

The Glendive District used a plant mix seal over PCCP on I-94, which has performed remarkably well.

11.2.11 3/8 In. Grade S Plant Mix Surfacing

3/8 in. Grade S with no chip seal is often used on MDT facilities in lieu of 3/4 in. PMS and a chip seal. Depending on project specifics, the overall cost of the two 3/8 in. Grade S (or 3/8" PMS) is structurally interchangeable with other super-pave mixes. 3/8 in. mix has similar aggregate consensus properties and Hamburg rut test performance requirements. [3/8 in. refers to the nominal maximum aggregate size (NMAS).] The asphalt content is generally higher as the NMAS goes down, so 3/8 in. mix is more expensive than the 3/4 in. mix predominantly used on MDT highways. Even though considered structurally equivalent, mixes with higher oil content can be more prone to rutting if not designed, crushed, or constructed correctly. Finer mixes usually result in better longitudinal joint construction. In Billings, 3/8 in. mix is used frequently on high volume urban roads as the smooth quiet riding surface is preferred by commuters, motorcycle riders, and bicyclists. 3/8 in. plant mix has the same LA Wear requirement of 30% max that is required of chip seals, compared to 40% for 1/2 in. and 3/4 in. Grade S mixes. This can lead to higher costs as some sources which produce good 3/4 in. mix cannot be used for 3/8 in. PMS. 3/8 in. PMS has good skid resistance and has been used successfully on high speed rural roads. Lift thickness of 0.10-0.20 ft. are usually specified.

11.2.12 Cape Seal

A cape seal incorporates micro surfacing over the top of a chip seal. For a reduced cost, a cape seal combines the benefits of both systems. This has proved to be a very economical treatment for low volume road in some states that cannot afford the higher price of asphalt overlays. While the more flexible CRS-2P seals the existing pavement well, the durable chip seal is then covered with the pleasant riding surface provided by the micro surfacing. The flexible chip seal is thought to act as a buffer with the more rigid micro surfacing to help delay reflective cracking. Ride quality of the existing surfacing should be expected to be maintained except for improvement where thermal cracks are mitigated. Rutting can be improved, particularly if more than one course of micro surfacing is used. This combination of surfacing provides an increased thickness of the wearing surface and should have a longer service life in areas where traffic wears quickly through the wheel paths of the surfacing course. The Surfacing Design Unit is actively seeking additional cape seal candidates.

11.2.13 Inverted Cape Seal

As the name implies, an inverted cape seal includes micro surfacing placed on the existing pavement followed by a chip seal. The rationale for this treatment is to correct rutting of the pavement and then add a chip seal to avoid immediate reflective cracking on the pavement surface. The micro surfacing will crack soon after placement, while the chip seal will tend to mask cracking and heal over these reflective cracks. The relatively soft CRS-2P tends to reactivate in hot summer temperatures and can delay the need to crack seal the pavement for a couple of years.

11.2.14 Fiber Reinforced Plant Mix

Fibers have been used to improve the performance characteristics of Hot Mix Asphalt (HMA). Similar to fiber mesh used in concrete slabs, the fibers provide added tensile reinforcement beyond what is provided by the asphalt binder. Testing has shown improved cracking and rut resistance. Various materials have been used in the past, but all must withstand the high temperatures that mix is subjected to in asphalt plants. Proper and uniform distribution into the mix is also critical. A variety of lengths are available as well. As with any technology, the benefits must be evaluated to determine if the additional cost is worth the performance enhancement. MDT is evaluating this technology for urban pavement preservation projects, which are limited to a 0.20 ft. mill and fill. Often these roads are selected for preservation by a municipality but may be poor candidates for preservation. Industry markets fibers as a way to reduce asphalt overlay thickness.

11.2.15 Hot-In-Place Recycling (HIR)

The Basics in Asphalt Recycling Manual (BARM) defines HIR as “*..An on-site, in-place maintenance/rehabilitation method which consists of heating, softening, scarifying, mixing, placing and compacting the existing pavement. Rejuvenating agents (rejuvenation oil, rejuvenating emulsion or in some cases a soft binder) and additives such as admixture, consisting of the new plant-mixed hot or warm mix asphalt(HMA/WMA), or new aggregates can be integrated into HIR mixtures to improve the characteristics of the recycled pavement. There are three sub-disciplines of HIR, Surface Recycling, Remixing and Repaving. There are many variations within the sub-disciplines of HIR based on heating and mixing methods, admixture addition and the use of integral overlays but they all fall within one of the three HIR sub-disciplines.*”(6)

MDT constructed initial HIR projects in the 1990s with mixed results. The industry has made progress through advancements in additives, technology, and equipment automation. HIR should be sealed within the same construction season with a HMA overlay or chip seal. HIR is marketed to save around 25% over the cost of a traditional mill and fill. Candidate projects should be around 5 miles or longer. Areas that lack aggregate sources or where long hauls are common are often viable candidates. HIR trains cannot mill directly adjacent to bridge decks, and therefore some virgin HMA may be required. HIR equipment is heavy, and the trains are fairly long, so sharp winding roads or those with no place to park the train at night may be less desirable candidates.

11.2.16 Cold-In-Place Recycling (CIR)

The Basics in Asphalt Recycling Manual (BARM) provides this description of CIR: “*CIR consists of recycling asphalt pavement without the application of heat during the recycling process to produce a rehabilitated pavement. The CIR process uses a number of pieces of equipment including tanker trucks, milling machines, crushing and screening units, mixers, pavers, and rollers. Like HIR, the combined equipment spreads out over a considerable distance and therefore, is commonly referred to as a “train.” CIR is undertaken on site and generally uses 100 percent of the RAP generated during the process. The CIR treatment depth is typically within the 2 to 4 inches (50 to 100 mm) range when the recycling agent is only an asphalt emulsion or an emulsified recycling agent. Treatment*

depths of 5 to 6 inches (125 to 150 mm) are possible when chemical additives, such as Portland cement, lime, kiln dust or fly ash are used to improve the early strength gain and resistance to moisture damage. If lime or Portland cement is added to the recycled mix, they can be added in dry form or as slurry. The slurry method eliminates potential dust problems and permits greater control of the amount of recycling modifier being added.”(6)

MDT has constructed several CIR projects over the years. Historically, lime slurry was used as the mineral filler with many successful outcomes. At times, there were difficulties with curing the surfacing prior to placement of the chip seal or overlay. Allowing dry cement provides advantages because less moisture is introduced into the system. It is important to seal CIR projects prior to winter shutdown. Candidate projects should be around 5 miles or longer. The engineered emulsion used in CIR requires heat to cure, so projects located in narrow shaded canyons, for example, are not good candidates for CIR. Areas that lack aggregate sources or where long hauls are common are often viable candidates. CIR trains are fairly long, so sharp winding roads or those with no place to park the train at night may be less desirable candidates. CIR will restore the roadway by eliminating ruts and cracking. It is thought that the high void content helps to slow reflective cracking from the underlying surfacing. A comprehensive report evaluating on MDT’s CIR projects is available at the following MDT website:

[MDT CIR Project Report](#)

11.2.17 Concrete Overlays (White-topping)

MDT has trended toward mostly flexible pavements because of good performance, low traffic volumes, and a strong asphalt supplier and contractor presence. Some flexible pavements in urban areas are troublesome because of repeated rutting. Composite pavements have proved to be a viable solution, providing excellent performance for over longer than expected service lives. White topping involves placing a relatively thin concrete pavement over an asphalt pavement. Both components are relied upon to meet the structural demand. Design advancements and a growing list of successful projects have provided momentum for concrete overlays. Ultra-thin white topping down to 2-3 in. thick has successfully performed in many states. Macro-fibers have also improved fatigue performance. Joints are spaced closer than conventional PCCP, down to 3 ft. spacing. White-topping should be considered in many of Montana’s urban areas where traffic volumes are growing significantly. It is also viable for many line pavements, particularly where studded tires and poor aggregates cause shorter than normal service lives in flexible pavements.

11.3 RESOURCES

This document provides limited detail on several commonly available surfacing treatments. Many resources exist which provide more specific details on each of these processes. Additionally, there are unique processes which are specific to contractors, some of which are proprietary. Material suppliers and contractors are a useful source of information despite having a vested interest in promoting their specific product.

The following resources can provide more information on many of the processes identified in this document.

- MDT Pavement Management Manual
- Pavement Interactive www.pavementinteractive.org
- National Center for Pavement Preservation (NCPPI) www.pavementpreservation.org
- FHWA Pocket Guides and Publications <https://www.pavementpreservation.org/technical-resources/fhwa-preservation-brochures/>
- International Grooving and Grinding Association (IGGA) www.igga.org
- International Slurry Surfacing Association (ISSA) www.slurry.org
- National Concrete Pavement Technology Center (NCPTC) www.cptechcenter.org
- http://www.cptechcenter.org/technical-library/documents/preservation_guide_2nd_ed_508_final.pdf
- Asphalt Recycling and Reclaiming Association (ARRA) www.arra.org
- Basic Asphalt Recycling Manual (BARM) 6)
- Asphalt Institute www.asphaltinstitute.org
- American Concrete Paving Association www.acpa.org

11.4 REFERENCES

1. LA County. Pavement Condition Chart. Website: <http://dpw.lacounty.gov/gmed/lacroads/Aboutroad.aspx>.
2. FHWA/TxDOT. *Guidelines for the Use of Underseals as a Pavement Moisture Barrier*. Website: <http://tti.tamu.edu/documents/0-4391-1.pdf>.
3. International Slurry Surfacing Association's (ISSA). *Recommended Performance Guidelines for Emulsified Asphalt Slurry Seal, A105*. 2001.
4. International Slurry Surfacing Association's (ISSA). *Recommended Performance Guidelines for Micro-Surfacing, A143*. 2001.
5. Pavement Interactive Website: www.pavementinteractive.org.
6. FHWA. *Basic Asphalt Recycling Manual*. FHWA, Washington, D.C., 2015.

MONTANA DEPARTMENT OF TRANSPORTATION

PAVEMENT DESIGN MANUAL

Chapter 12

Bridge End Pavement Design

November 2018



Contents

CHAPTER 12 BRIDGE END PAVEMENT DESIGN	12-1
12.1 Introduction.....	12-1
12.2 The Bridge End Pavement Problem	12-1
12.3 General Bridge End Pavement Design Process.....	12-4
12.4 30-year Bridge End Pavement Design Overview	12-7
12.4.1 New Bridge and/or Road Reconstruction	12-7
12.4.2 Pavement Major Rehabilitation	12-11
12.5 Reinforced Bridge End Pavement Design Overview	12-11
12.5.1 Reinforced Bridge End Pavement Design Example.....	12-12
12.5.2 Reinforced Bridge End Pavement Designs – Chip Seal Projects	12-13
12.5.3 Reinforced Bridge End Pavement Designs – Thin Overlay and Minor Rehabilitation Projects	12-13
12.6 References	12-14



Chapter 12

Bridge End Pavement Design

12.1 INTRODUCTION

The following guidelines are to assist MDT designers in scoping and designing 30-year and reinforced bridge end pavements. This refers to the pavement section that is adjacent to bridge ends or other fixed objects and often deteriorates faster than the mainline pavement.

There are two types of bridge end pavement treatments: 30-year and reinforced bridge end pavements. The 30-year bridge end pavement is usually designed on reconstruction and major rehabilitation projects. The reinforced bridge end pavement refers to bridge end treatments done on minor rehabilitation and thin overlay projects.

The following outline shows how these guidelines are organized:

- **Section 12.2:** Explains the bridge end pavement problem and why it occurs.
- **Section 12.3:** Begins with a general overview of the bridge end pavement design process, as well as Exhibit 12-4 which outlines the design processes for different types of construction projects.
- **Sections 12.4 and 12.5:** Include detailed design processes for 30-year and reinforced bridge end pavements, respectively.

12.2 THE BRIDGE END PAVEMENT PROBLEM

Often, the pavement located adjacent to bridge ends has more pavement distress than the mainline pavement. This is because the pavement within about 200 ft. of bridge ends is usually thinner than the mainline pavement.

It is MDT's policy to use a 20-year design life when designing new pavements. The 20-year pavement design life refers to a pavement that lasts for 20 years from initial construction to the point in time where the pavement has deteriorated and

has an unacceptably rough ride. The 20-year design life assumes that there is no preventative maintenance applied to the pavement during its design life.

In practice, it is MDT's policy to apply preventative maintenance treatments to pavements so that the ride stays smooth. Often the preventative maintenance treatment is an asphalt overlay, which adds pavement thickness to the original pavement. Usually, as a result of asphalt overlays, pavements with 20-year pavement design lives last for 30 years or longer.

This generally presents a problem for the pavement located adjacent to a fixed structure, such as a bridge end. In these locations, asphalt thickness cannot be increased since asphalt overlays are taper milled flush with the bridge end. Due to this, the pavement adjacent to the bridge does not receive additional pavement structure, and theoretically should last only 20 years. An example of this is shown in Exhibit 12-1.

Exhibit 12-1
Example of Multiple
Overlays Tapering into
Bridge End

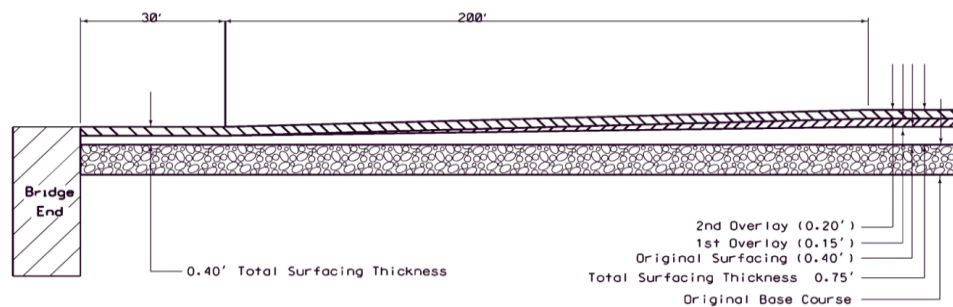

Since the bridge end pavement only lasts 20 years while the mainline pavement usually lasts 30 or more years, bridge end pavement deteriorates sooner than the mainline pavement.

Bridge end pavement is also subjected to increased truck loadings. Trucks tend to "bounce" when approaching and departing bridges. The bouncing applies additional dynamic forces upon the bridge end pavement as well as the bridge itself. These additional forces can double the amount of pavement damage caused by a normal truck.

This problem is most prevalent on the Interstate system. The majority of MDT's Interstate pavements were paved with 0.35 ft. PMS when originally constructed. Often, these bridge ends exhibit pavement distress since 0.35 ft. PMS is too thin for today's traffic loadings. Exhibit 12-2 and Exhibit 12-3 show examples of Interstate bridge end pavement distress.

The opposite is true on low to moderate traffic roadways which often perform fine, and there is no need to reinforce the bridge end pavement section. A few reasons why these bridge ends perform fine are:

- In the past, many of these pavements were overdesigned.
- Periodic taper mill/filling has added enough pavement structure to refresh the pavement surfaces.
- Many bridges on these roadways are paved over during asphalt overlay projects, so there is no need for taper milling at the bridge ends.
- Fewer truck loadings.



Photo Source: MDT

**Exhibit 12-2
Interstate Bridge Approach
Pavement Distress**



Photo Source: MDT

**Exhibit 12-3
Interstate Bridge Departure
Pavement Distress**

12.3 GENERAL BRIDGE END PAVEMENT DESIGN PROCESS

Bridge end pavements will often need a heavier, thicker pavement treatment than the mainline pavement. This will either restore the pavement structure on pavement maintenance projects or provide a 30-year pavement life in the case of major rehabilitation and road/bridge reconstruction projects.

For design purposes, there are two types of bridge end pavement treatments that are used by MDT:

- **30-Year Bridge End Pavement Design** - For bridge and/or road reconstruction and road major rehabilitation projects, bridge end pavements should be designed for a 30-year pavement life utilizing a *30-year Bridge End Pavement Design*. The purpose of this is to design the bridge end pavement section to last as long as the mainline pavement section.
- **Reinforced Bridge End Pavement Design** - For existing pavements that are receiving a pavement maintenance treatment, the bridge end pavement should be treated with a *Reinforced Bridge End Pavement Design* when necessary. Reinforced Bridge End Pavement Designs refer to designing bridge end pavements so that they perform similarly to the existing mainline pavement section.

The intent of the bridge end pavement treatment is to address pavement issues only. It does not address the common bump caused by bridge end pavement settlement. This refers to the bump located at the bridge/pavement interface, caused by the pavement settling lower than the top of the bridge deck. Usually, this settlement is rooted beneath the pavement section. It may be caused by inadequate embankment compaction, further densification and consolidation of embankment, and/or embankment foundation materials occurring after initial construction.

Often in the case of bridge end pavement settlement, settlement occurs shortly after construction and then stops sometime after construction. The settlement stops after the embankment materials have reached equilibrium and their maximum density. In cases when bridge end pavement settlement has either stopped or is not an issue, **care should be taken to not excavate more than is necessary to provide for either the 30-year or Reinforced Bridge End Pavement Section.** Excavating deeper than needed may disturb otherwise stable soils and may result in a new settlement problem when the virgin materials settle after construction.

Exhibit 12-4 provides an overview of bridge end pavement design.

Care should be taken to not excavate more than is necessary to provide for either the 30-year or Reinforced Bridge End Pavement Section.

Exhibit 12-4 Bridge End Pavement Design Overview

Project Type	Bridge End Pavement Design Type (Design Life)	Recommended Treatment and How to Choose Bridge End Treatment Locations	Design Method and Reporting	Field Testing
Road and Bridge Reconstruction	30-year Bridge End Design (30 Years)	Construct 30 year Bridge End Design at all Bridge Ends	The surfacing design unit will provide Bridge End Pavement Designs. These designs will be provided as part of the preliminary and final surfacing design memorandums (Activity 600 and 604), or by email when needed.	Road Construction with Existing Bridge – During District Soil Survey add Soil Borings at Bridge Ends Road Construction with New Bridges – Use Soil Survey Borings for Pavement Design, no Additional Borings Needed at Bridge Ends
Major Rehabilitation	30-year Bridge End Design (30 Years)	Deep mill/fill exposing base course Construct 30-year Bridge End Pavements at all Bridge Ends	The surfacing design unit will provide Bridge End Pavement Designs with input from the Geotechnical Section as part of the preliminary and final surfacing design memorandums (Activity 600 and 604), or by email.	Pavement Major rehabilitation with Existing Bridge - During District Soil Survey add Soil Borings at Bridge Ends Pavement Major Rehabilitation with New Bridges – Use Soil Survey Borings for Pavement Design, no Additional Borings Needed at Bridge Ends
Minor Rehabilitation and Thin Overlay	Reinforced Bridge End Design	Deep mill/fill not exposing base course Bridge End Pavements that have more Load-Associated Pavement Distress than the Mainline Pavement.	If there are bridge ends that are severely distressed and need to be rebuilt or major rehabilitated, follow the guidelines for Major Rehabilitation projects (above). The locations will be determined and “field designed” during the Preliminary Field Review (PFR). The Design Project Manager (DPM) will make the formal request to the District to take bridge end pavement cores at those locations. After core testing is completed, the surfacing design unit will review test results and send final recommendations to the DPM for inclusion into the Scope of Work Report.	Deep mill/fill – Take pavement core at bridge end for thickness measurement and stripping analysis
Surface Seal (Chip Seal, Micro surfacing, etc.)	Do not treat bridge end pavements differently from mainline. However, there may be chip seal projects where bridge end pavements need to be treated with more than a chip seal. Those locations should be identified during the preliminary field review, and designed using the guidance for Major Rehabilitation (for severely distressed pavement) or Minor Rehabilitation/Thin Overlay located in above within this table.			

This page intentionally left blank.

12.4 30-YEAR BRIDGE END PAVEMENT DESIGN OVERVIEW

30-year bridge end designs should be included on bridge end pavements where the existing pavement is treated in a manner that provides a 20-year pavement design life. These projects include bridge/road reconstruction, major rehabilitation, and engineered overlay projects.

The purpose of designing bridge end pavements with 30-year design lives is so that the resulting pavement performs similarly to the mainline pavement. This should result in more uniform pavement performance between the bridge end and mainline pavements.

30-year bridge end pavements should be designed at all bridge ends as well as other fixed objects that will limit future grade raises such as railroad tracks or cattle guards, but not where the fixed object is an adjacent asphalt pavement.

The surfacing design unit will be responsible for providing the 30-year end pavement section pavement thicknesses, treatment length, and other pavement related issues. The Surfacing Design Unit will also work with the Geotechnical Section regarding use of special borrow and bridge end backfill. The Surfacing Design Unit will verify that the 30-year bridge end is incorporated into the plan set at the appropriate time.

12.4.1 New Bridge and/or Road Reconstruction

These projects provide the greatest opportunity to design a 30-year bridge end since the pavement will be built new or removed and replaced within its entirety.

Exhibit 12-5 and Exhibit 12-6 should be used as a starting point for the 30-year pavement design. These figures are based on the 20-year pavement design designed for the mainline pavement. Previous analysis has shown that the additional plant mix thickness shown within the figures will provide a 30-year design life in most situations. Note that the subgrade elevation is the same beneath the bridge end and mainline pavement sections to enhance constructability.

For projects in which both the bridges and adjacent pavement are to be reconstructed, a conventional soil survey should be adequate for bridge end pavement design; additional soil survey and geotechnical borings should not be needed at bridge ends. The Surfacing Design Unit should use the same subgrade R-Value for designing both the bridge end and mainline pavement sections.

For projects in which the pavement will be reconstructed next to an existing bridge, additional soil survey borings should be taken at the bridge ends. The Surfacing Design Unit will communicate with the District Materials lab to let them know which bridge ends will need borings done. This communication will occur after the preliminary field review.

This page intentionally left blank.

Exhibit 12-5 Example 30-year Bridge End Pavement Detail for Low to Moderate Truck Traffic

DETAIL

LOW/MODERATE TRAFFIC 30-YEAR BRIDGE END DESIGN FOR ROAD RECONSTRUCTION PROJECTS* (ROADWAYS WITH < 500 DAILY ESALS)
NO SCALE

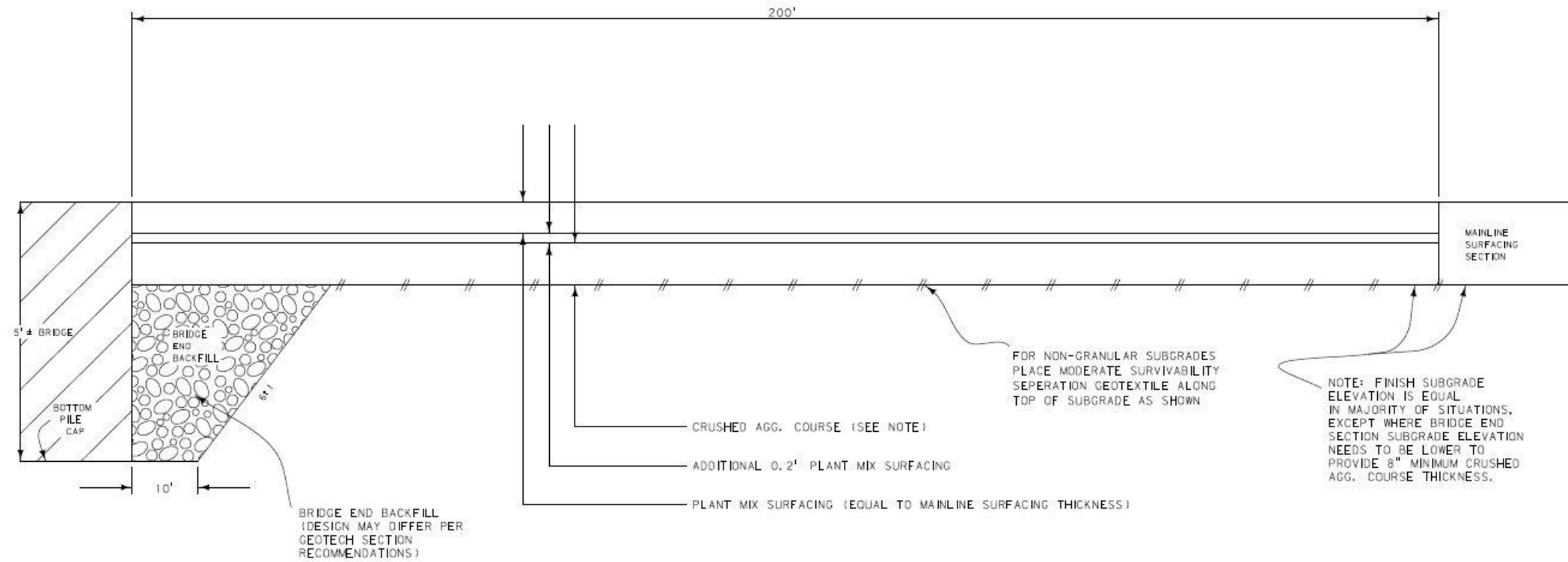

NOTE: CONSIDER USING SPECIAL BORROW EXTENDING 80' FROM BRIDGE WHEN SUBGRADE IS A-4/A-6/A-7 OR ON LOCATIONS WHERE BRIDGE END DISTRESS HAS OCCURED PREVIOUSLY.

* THIS DETAIL IS FOR ROAD RECONSTRUCTION PROJECTS. FOR OTHER PROJECT TYPES, ALL DIMENSIONS ARE THE SAME EXCEPT FOR PMS AND CAC THICKNESSES. CONTACT MDT SURFACING DESIGN UNIT AND PMS AND CAC THICKNESSES WILL BE PROVIDED.

Exhibit 12-6 30-year Bridge End Pavement Detail for Interstates and Roadways with High Truck Traffic

DETAIL

INTERSTATE/HIGH TRAFFIC 30-YEAR BRIDGE END DESIGN FOR ROAD RECONSTRUCTION PROJECTS* (ROADWAYS WITH ≥ 500 DAILY ESALS)
NO SCALE

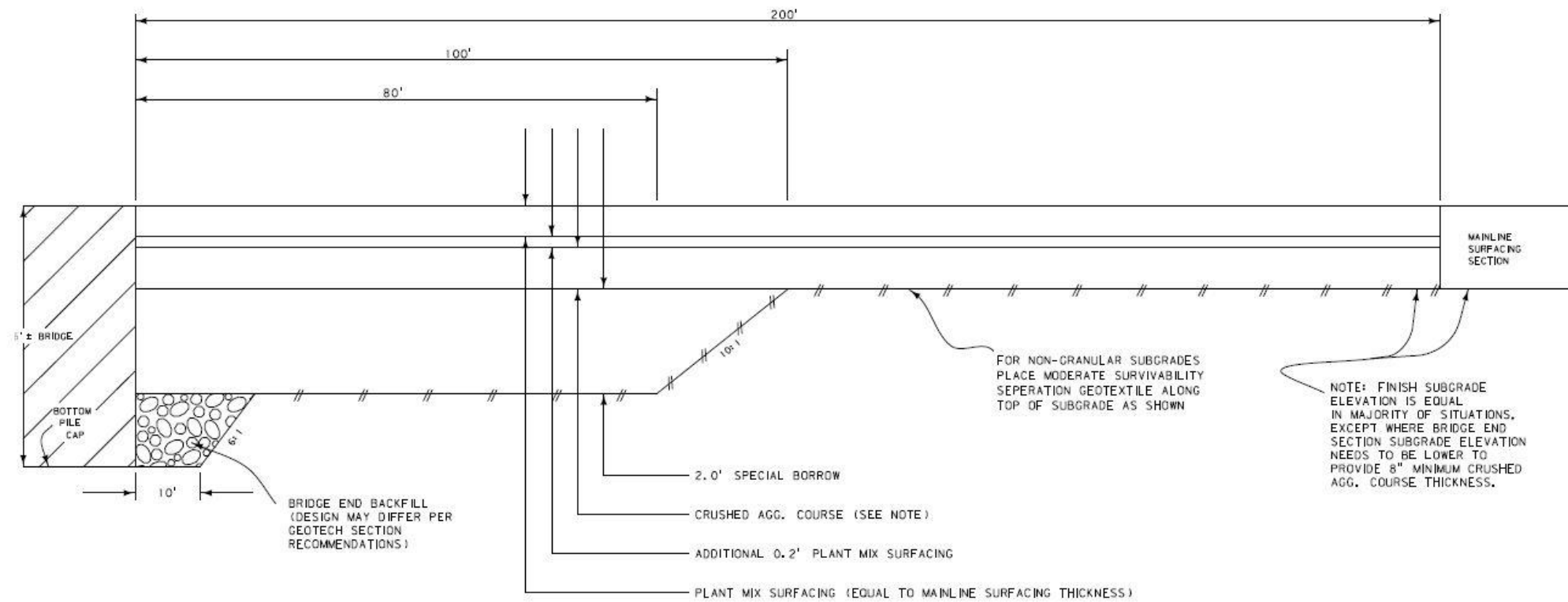

* THIS DETAIL IS FOR ROAD RECONSTRUCTION PROJECTS. FOR OTHER PROJECT TYPES, ALL DIMENSIONS ARE THE SAME EXCEPT FOR PMS AND CAC THICKNESSES. CONTACT MDT SURFACING DESIGN UNIT AND PMS AND CAC THICKNESSES WILL BE PROVIDED.

For projects in which the pavement will be reconstructed next to an existing bridge and there is severe pavement distress and/or embankment settlement at the existing bridge end pavement sections, a more thorough geotechnical investigation should be considered. The intent of the investigation will be to identify embankment and foundation soil problems beneath the pavement section, and to design a deeper solution to address these problems. These locations will be identified at the preliminary field review by the Surfacing Design Unit and/or Geotechnical Section. Additional borings and evaluation will be done as determined necessary by the Geotechnical Section.

When necessary, the Geotechnical Section will provide both bridge end backfill and special borrow type, thickness, and extent. If pavement drainage problems are determined to be the cause of bridge end pavement distress in these locations, the Geotechnical Section will provide drainage details.

12.4.2 Pavement Major Rehabilitation

On major rehabilitation projects, often the existing PMS is removed in its entirety or pulverized into the existing base. The mainline pavement is normally designed for a 20-year design life, and the bridge end pavement should be designed with a 30-year design life.

Ideally, the 30-year bridge end should be designed by thickening the PMS section while utilizing the existing base course by leaving it in place. For example, if the mainline pavement is milled, pulverized, and overlaid with 0.4 ft. PMS, the 30-year bridge end pavement may consist of deep milling, pulverizing, and placing a 0.6 ft. PMS overlay.

In locations where the existing bridges will remain in place during the pavement major rehabilitation, all bridge ends should be examined during the Preliminary Field Review. In locations where the bridge end pavement appears structurally sound, with no evidence of subgrade failure, the 30-year bridge end pavement should be designed using additional PMS thickness as described above. In locations with moderate to severe pavement distress, pavement subgrade problems, or indications of embankment problems, a deeper 30-year bridge end pavement should be designed.

All bridge end pavements should be bored during the District Material's lab soil survey to provide information for the bridge end pavement design. Bridge end borings should be characterized using the laboratory tests normally done during a soil survey.

12.5 REINFORCED BRIDGE END PAVEMENT DESIGN OVERVIEW

For pavement maintenance/preservation projects, the pavement treatment is not designed for a 20-year design life. Instead the pavement treatment that is selected will provide the most cost-effective design life for the particular pavement. Pavement maintenance projects refer to minor rehabilitation, thin asphalt overlay, chip seal, or other treatments that typically do not expose base course during pavement construction.

On these projects, a reinforced bridge end pavement section that will provide pavement performance similar to the mainline pavement should be used. The resulting treatment will reduce bridge end pavement maintenance and will place both the bridge end and mainline pavement on a similar pavement maintenance cycle. This is explained more thoroughly in the following example.

12.5.1 Reinforced Bridge End Pavement Design Example

During a preliminary field review of a thin overlay project, it is determined that the bridge end pavements have more fatigue cracking than the mainline pavement. It is probable that if the bridge ends are not treated differently than the mainline pavement, the bridge ends pavements will degrade faster than the mainline pavement and will need reactive maintenance before the mainline pavement.

During their discussion, the Preliminary Field Review (PFR) attendees agree that the 0.20 ft. thin overlay project is expected to last 15 years before another pavement treatment is needed.

In this example, the bridge end pavement should be designed so that it deteriorates at a similar rate as the mainline pavement which has a 15-year design life. Based on the pavement condition and engineering judgment, the PFR attendees estimate that a mill/fill 0.40 ft. deep within 200 ft. of the bridge ends should result in the bridge end pavements performing similarly to the mainline pavement.

As a general rule of thumb, bridge end pavements that are in similar condition as the mainline pavement should not receive a reinforced bridge end pavement treatment. In other words, if there is nothing wrong with the bridge end pavement, it should be treated the same as the mainline pavement. However, there will be projects in which no bridge end distress is present but an increase in truck traffic is predicted. In these locations, the District may decide to preemptively reinforce the bridge end pavements in anticipation of the future traffic increase. A few examples include: roadways within developing oil field or in the vicinity of future gravel pits, mines, or agricultural infrastructure.

Generally, pavement maintenance and preservation projects are usually fast track designs that may not provide adequate time for thorough geotechnical and pavement investigations for designing reinforced bridge end pavements. Project letting dates on these projects should not be pushed out into the future as a result of designing reinforced bridge end sections. **Therefore, in the interest of time, non-engineered designs based on engineering judgment should be used whenever possible.**

Locations and types of reinforced bridge end treatments should be determined during the PFR. During the PFR, the attendees should examine all bridge ends and identify locations where reinforced bridge end treatments are needed. The surfacing representative should field design a *preliminary* reinforced bridge end treatment for inclusion into the PFR report. This will require a surfacing design representative to be present at these PFRs. The Geotechnical Functional Manager will normally not need to be present, but may be called upon in the event that bridge end pavements are showing distress due to poor subgrade support.

As a general rule of thumb, bridge end pavements that are in similar condition as the mainline pavement should not receive a reinforced bridge end pavement treatment.

Non-engineered designs based on engineering judgment should be used whenever possible.

12.5.2 Reinforced Bridge End Pavement Designs – Chip Seal Projects

The intent of a chip seal project is to seal the existing pavement. Often there is no equipment available on these projects to perform anything beyond a chip seal on the bridge end pavement. Therefore, the design team should not provide a reinforced bridge end pavement design unless significant pavement distress is observed during the project nomination and preliminary field reviews. However, that should be the exception to the rule.

If bridge end pavement distress is observed and/or is a reoccurring pavement maintenance issue, the design team should coordinate with the District to decide whether reinforced bridge end pavements should be built. If it is decided to reinforce the bridge end pavements, care should be taken to provide a treatment that does not expose base gravel. Also, it should be recognized that adding a reinforced bridge end pavement will significantly increase the overall project cost.

A starting point for reinforced bridge end pavement design on these projects is a mill/fill extending 200 ft. from the bridge end within the travel lanes. Both the mill/fill length and thickness should be designed during the PFR based upon field observation.

Reinforced bridge end pavement designs that expose base course should not be done on chip seal projects unless the District makes a special request.

The Geotechnical Section will usually not be involved in the bridge end pavement design on these projects. Construction input should be minimal since these treatments usually do not inconvenience the travelling public very much, and constructability issues should be infrequent due to the simplicity of these treatments.

12.5.3 Reinforced Bridge End Pavement Designs – Thin Overlay and Minor Rehabilitation Projects

Reinforced bridge end pavement should be considered on all bridge ends and fixed objects where the bridge end pavement shows load-associated pavement distress or has reoccurring maintenance issues. It is not necessary to provide reinforced bridge end pavements in locations where the fixed object is an asphalt pavement, or in locations where the bridge end pavement is in good structural condition and/or in similar condition as the mainline pavement.

The design life of the reinforced bridge end pavement should match the assumed design life of the overlay. This means that if an overlay is anticipated to last 12 years before the next pavement treatment (excluding surface seals), then the bridge end pavement should be designed to last the same amount of time without maintenance patching and/or alligator crack sealing. Determining design life is subjective and should be done during the PFR using engineering judgment based on past performance of the mainline pavement.

The decision point on whether reinforced bridge end pavement designs will be built is during the PFR. A surfacing design representative must be present to participate in the review. At the PFR, each bridge end should be evaluated by the design team. If possible, the bridge end pavements should be preliminarily designed at the PFR. Pavement cores should be collected and tested for stripping

and thickness to design the mill/fill depth. Care should be taken to provide a treatment that does not expose base gravel. However, Reinforced Bridge End Pavement Designs that expose base course can be done on a thin overlay if needed to address significant pavement deterioration and/or attain the desired design life.

The standard reinforced bridge end pavement design on these projects should be a deep mill/fill extending 200 ft. from the bridge end within the travel lanes. Both the mill/fill length and thickness should be designed based upon field observation. A “deep” mill/fill is a mill/fill that is thicker than the asphalt overlay. For example, on a 0.20 ft. asphalt overlay project, the reinforced pavement bridge end section may consist of increasing the mill depth to 0.4 ft. depth extending 200 ft. from the bridge end.

The Geotechnical Section will usually not be involved in the bridge end design on these projects. Construction input should be minimal since these treatments usually do not inconvenience the travelling public very much, and constructability issues should be infrequent due to the simplicity of these treatments.

12.6 REFERENCES

No references were identified for this chapter.

MONTANA DEPARTMENT OF TRANSPORTATION

PAVEMENT DESIGN MANUAL

Chapter 13

Traffic Estimation – Special Cases

November 2018



Contents

CHAPTER 13 TRAFFIC ESTIMATION SPECIAL CASES ...13-1

13.1 Rest Areas.....	13-1
13.2 Sugar Beet Truck Routes	13-2
13.3 Wheat Truck Routes	13-2
13.4 Oil Production and Exploration	13-2
13.5 References	13-4



Chapter 13

Traffic Estimation – Special Cases

Pavements are often designed in areas where the Traffic Data Collection Unit's traffic estimates are unavailable or unable to capture future traffic generators. Some examples of this are interstate rest areas, energy sectors such as the Bakken Oil Field, and commodity haul routes near grain elevators. For these situations, the designer should work with the District traffic engineer and estimate the daily Equivalent Single Axle Load (ESAL). For special situations such as the Bakken Oil Patch, a report outlining traffic impacts may be available.

Agricultural commodities are a large industry, and a generator of heavy trucks during harvest times. Traffic data may not include commodity hauls in their traffic estimates since traffic counts may have not been done during harvest time. On roadways with commodity hauls, the designer should estimate the increased daily ESALs due to commodity hauls and add those ESALs to the daily ESALs provided by the Traffic Data Collection Unit. This is discussed further in the following sections.

13.1 REST AREAS

Use the following equation to estimate ESALs for rest area pavements, including approaches and entrance and exit ramps:

$$\text{Adjacent Mainline Pavement ESALs} \times 0.25 = \text{Rest Area ESALs}$$

For example, for an interstate pavement with 600 daily ESALs, the designer should use 150 ESALs for rest area pavement design.

13.2 SUGAR BEET TRUCK ROUTES

Sugar beets are grown abundantly in Montana, particularly in the Billings and Glendive Districts. There are two beet processing facilities, with one located near Hardin and the other near Sydney. There are also a number of storage facilities.

Sugar beets are a heavy commodity, similar to potatoes. Sometimes harvest takes place during late fall and winter. Transfer of the beets to the processing facility occurs over the winter and into spring. Spring thaws mark the time when pavements are in their weakest state. The designer should consider beet traffic when designing pavements in beet producing areas.

13.3 WHEAT TRUCK ROUTES

Wheat is grown abundantly in Montana. At harvest time, wheat is hauled via truck to large silos where it stored in grain elevators to be loaded onto trains. Recently, these grain elevators have been consolidating into very large facilities. **Error! Reference source not found.** These facilities generate a large amount of truck traffic, approximately 60 daily ESALs.

13.4 OIL PRODUCTION AND EXPLORATION

There are a number of areas in Montana with oil and gas reserves, but the area where pavements are most currently affected is within the Bakken formation in Northeastern Montana. Truck traffic increased tremendously within the Bakken Oil Field from 2010 to 2015. Designers should consider recommendations in Exhibit 13-4 **Error! Reference source not found.** when designing pavements within the Bakken Oil Field Area. The Upper Great Plains Transportation Institute (UGPTI) traffic predictions are located at the following website:

[UGPTI Traffic Predictions](#)

The Surfacing Design Unit can provide calculated design ESALs for consultant design projects. The report does not provide specific ESAL estimates. Exhibit 13-1 provides pavement design recommendations for the Bakken Oil Field Area.

**Exhibit 13-1
Bakken Oil Field Area
Pavement Design
Recommendations**

Project Type	Recommendation
Pavement Preservation	Use the Traffic Data Unit's traffic predictions for pavement design. Do not use UGPTI Traffic Predictions. Consider adding pavement structure utilizing thicker or stronger pavement treatments while still working with pavement preservation guidelines as outlined in the joint agreement.
Minor Rehabilitation	10-year design life using 20-rig UGPTI Traffic Predictions
Major Rehabilitation, Reconstruction and New Construction	20-year design life using 20-rig UGPTI Traffic Predictions

Research to predict future traffic growth within the Bakken Oil Field has been completed, and an overview of these predictions is shown in Exhibit 13-2 (1). The reference to “20-Rig Scenario” shown in the exhibit **Error! Reference source not found.** refers to 20 oil drilling rigs operating continuously within Montana. The “20-rig” assumption is thought to be reasonable and should be used for pavement design. Impacts have been seen in surrounding counties not included in the report and as such, care should be taken when estimating ESALs.

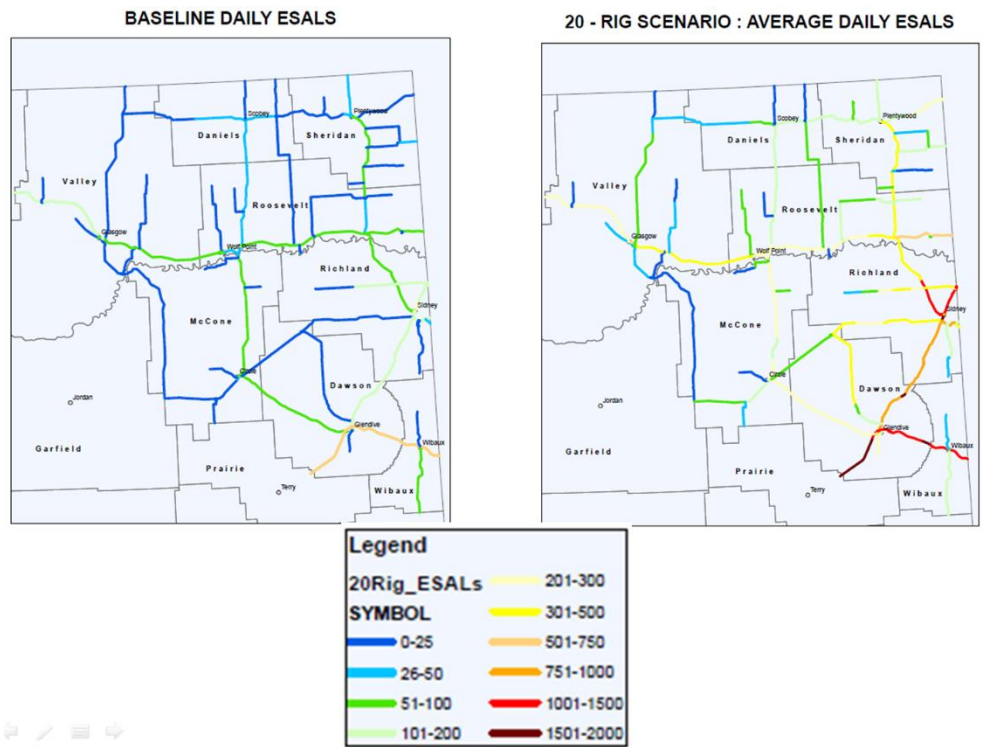

**Exhibit 13-2
Bakken Area Traffic
Increases (1)**

Most Bakken Oil Field drilling is within North Dakota, but many oil drilling supplies are hauled from Montana to North Dakota. The traffic generators for drilling supplies are shown in **Error! Reference source not found.**

Exhibit 13-3 Bakken Oil Traffic Generators (1)

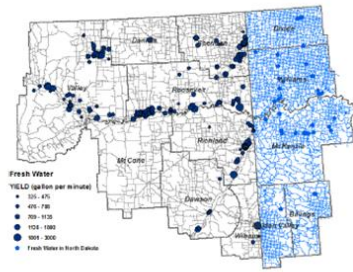

Freshwater

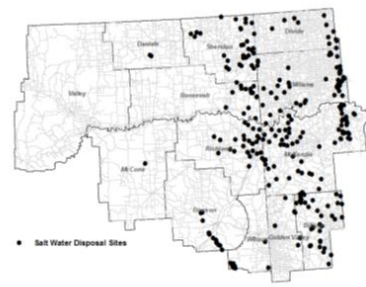

Saltwater Disposal

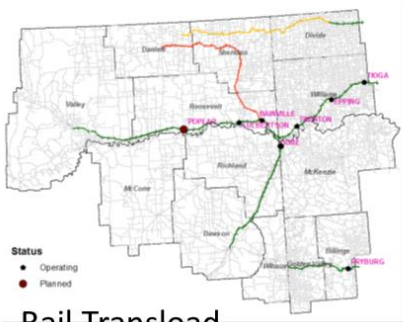

Rail Transload



Pipe Transload

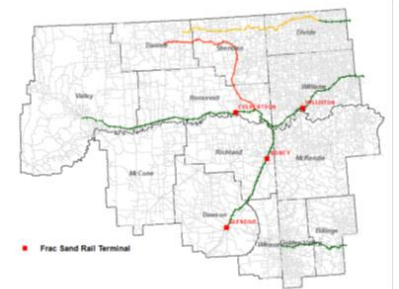

Frac Sand Rail Offload

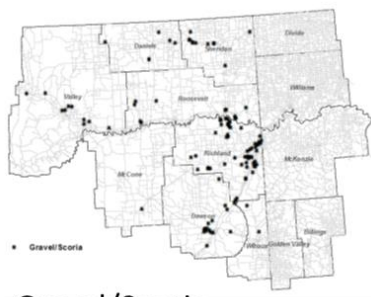

Gravel/Scoria



Oil Towns

13.5 REFERENCES

1. UGPTI. Impacts to Montana State Highways Due to Bakken Oil Development. MDT, Helena, MT, 2013.

MONTANA DEPARTMENT OF TRANSPORTATION

PAVEMENT DESIGN MANUAL

Chapter 14

Tools for Pavement Analysis

November 2018



Contents

CHAPTER 14 TOOLS FOR PAVEMENT ANALYSIS14-1

14.1 Introduction.....	14-1
14.2 Non-Destructive Testing.....	14-1
14.2.1 Falling Weight Deflectometer (FWD)	14-2
14.2.2 Ground Penetrating Radar Evaluation.....	14-5
14.2.3 Existing Pavement Sampling and Testing	14-7
14.3 Additional Pavement Analysis Tools	14-14
14.4 References	14-15



Chapter 14

Tools for Pavement Analysis

14.1 INTRODUCTION

Chapter 14 provides an overview of non-destructive testing (NDT) and additional pavement analysis tools. NDT includes information on conducting falling weight deflectometer (FWD) and ground penetrating radar (GPR) testing on MDT facilities. The additional tools used in pavement analysis include PathWeb, ride and rut information, a comprehensive pavement management tool and Path View.

14.2 NON-DESTRUCTIVE TESTING

The NDT Unit is responsible for conducting FWD and GPR testing on the state highway network on an ongoing basis. FWD and GPR testing can only occur on bound pavement surfaces. NDT provides analyzed data to both internal and external customers. Testing is done as follows:

- **Network level FWD/GPR:** This type of testing is conducted on all state roadways on a five-year rotation, meaning that there should be available FWD and GPR information that was collected in the last five years for all pavements. Network level FWD testing is done at 820 ft. increments within the outside wheel path of the driving lane in one direction only on two-lane roads. For Interstate and multi-lane facilities, excluding turning lanes, both directions are tested. GPR is collected continuously.
- **Project level FWD/GPR:** This type of testing is conducted prior to road construction projects. Project level FWD testing is done at 330 ft. increments within the outside wheel path of the driving lane in one direction only (or in both directions of Interstate pavements). GPR testing is **done** continuously. This testing is done before the Surfacing Design Unit's preliminary surfacing design activity (Activity 600). The following paragraphs summarize the testing and reporting of different types of projects.

Additional information on NDT can be found in the MDT Non-Destructive Testing Manual (1).

- **Reconstruction:** The NDT Unit analyzes this data and back-calculates the in-situ pavement structure M_R , which includes subgrade, base and pavement surfacing. The existing pavement and base layer M_R is not needed in the calculations for new pavement structure as it will be eliminated because of a new surfacing section. The Surfacing Design Unit receives the data summarizing the subgrade M_R in an Excel spreadsheet.
- **Major Rehabilitation:** The NDT Unit analyzes this data and determines the M_R of the in-situ subgrade, base course, and surfacing materials. GPR is also used to calculate PMS thickness continuously along the project length. Both GPR and FWD information are analyzed, graphed, and provided to the Surfacing Design Unit in an Excel spreadsheet.
- **Minor Rehabilitation:** The NDT Unit also tests minor rehabilitation projects for both FWD and GPR. The NDT Unit then provides the in-situ pavement structure M_R to the Surfacing Design Unit. GPR is analyzed for existing pavement section thicknesses used for back calculation. The analyzed GPR depths may also be used to determine appropriate milling depths.
- **Pavement Preservation:** GPR testing is conducted on lower traffic volume projects to report PMS thickness and to ensure that there is adequate PMS thickness for milling operations. GPR testing is not done for pavement preservation projects on the Interstate System due to the known structural integrity of the road. For seal and cover type projects only, GPR testing is not needed. The GPR information is analyzed, graphed, and provided to the Surfacing Design Unit in an Excel spreadsheet.

14.2.1 Falling Weight Deflectometer (FWD)

A FWD is a testing device used by civil engineers to evaluate the physical properties of pavements. FWD data is primarily used to estimate pavement structural capacity 1) for overlay design and 2) to determine if a pavement is being overloaded. Usage includes (but is not limited to) highways, local roads, airport pavements, and railway tracks.

The FWD is designed to impart a load pulse to the pavement surface which simulates the load produced by a rolling vehicle wheel. The load is produced by dropping a large weight and is transmitted to the pavement through a circular load plate – typically 12 in. in diameter. A load cell mounted on top of the load plate measures the load imparted to the pavement surface. The load plate can be solid or segmented. The advantage of a segmented load plate is that it adapts to the shape of the pavement, giving an even distribution of the load on uneven surfaces. MDT's NDT Unit also incorporates a swiveling knuckle to ensure proper surface contact.

There are two different types of load impact systems: single-mass and double-mass. In a single-mass system, which MDT utilizes, a weight is dropped onto a single buffer connected to a load plate, which rests on the surface being tested. The load force is transferred through the plate, and the plate creates a deflection that

simulates a wheel load. In the double-mass system, typically used for very thick sections such as airport runways, the weight drops onto a double-buffer system, which includes a first buffer, a second weight, and a second buffer.

Deflection sensors (geophones; force-balance seismometers) mounted radially from the center of the load plate measure the deformation of the pavement in response to the load. MDT's sensor placements are 0 in., 8 in., 12 in., 18 in., 24 in., 36 in., 48 in., and 60 in.

FWD data is most often used to calculate stiffness-related parameters of a pavement structure. The process of calculating the elastic moduli of individual layers in a multi-layer system (e.g., asphalt concrete on top of a base course on top of the subgrade) based on surface deflections is known as "back calculation," as there is no closed-form solution. Instead, initial moduli are assumed, surface deflections calculated, and then the moduli are adjusted in an iterative fashion to converge on the measured deflections. This process is computationally intensive although quick on modern computers. It can give quite misleading results and requires an experienced analyst.

The FWD process consists of first lowering the mass of weight and the rack of sensors called "geophones" that measure deflections to the roadway surface. The weight and rack of sensors are located in the back of the truck, just behind the rear axle (Exhibit 14-1). Next, a large weight is dropped to mimic a heavy truck tire and measures how much the pavement deflects beneath the weight. The weight is approximately 9,000 lbs. which is meant to represent an 18,000 lb. (18-kip) ESAL.

The deflection is measured in eight locations by geophones located in the following distances from the center of the load plate; $D_1 = 0$ in., $D_2 = 8$ in., $D_3 = 12$ in., $D_4 = 18$ in., $D_5 = 24$ in., $D_6 = 36$ in., $D_7 = 48$ in., and $D_8 = 60$ in. All deflections measure the deflection basin as shown in Exhibit 14-2.

Exhibit 14-1 shows one of the two NDT vehicles with both GPR and FWD equipment mounted on it.

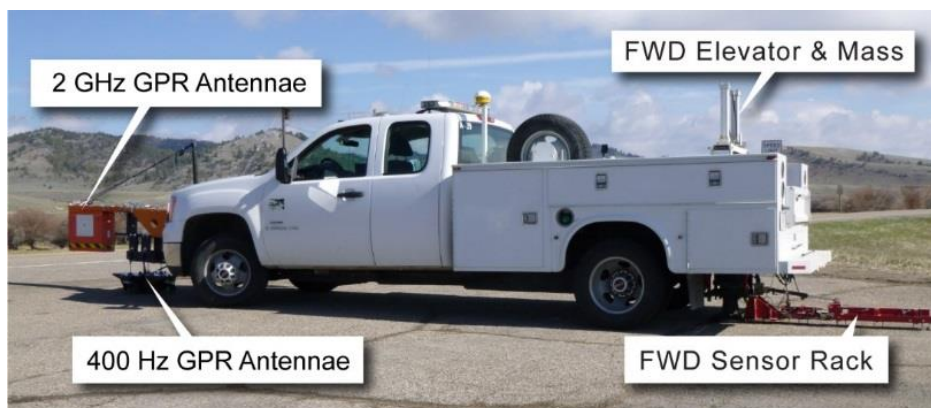
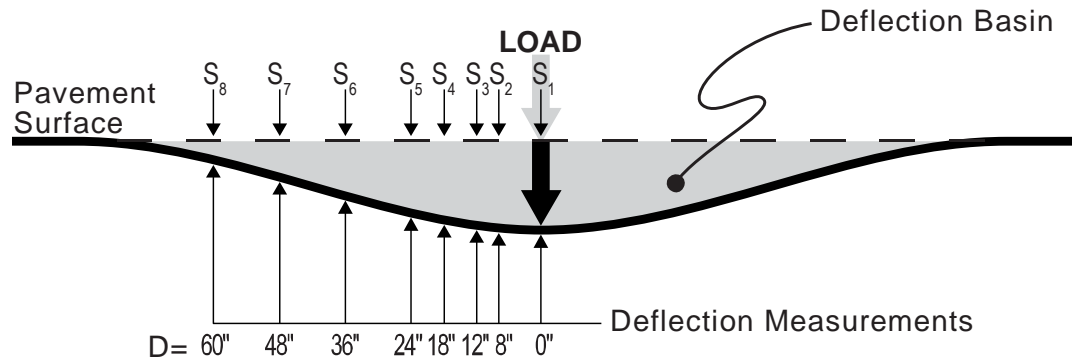

Exhibit 14-1
NDT Vehicle with GPR
and FWD

Exhibit 14-2
Example Deflection
Basin



Analysis of FWD Deflection Basins

The deflection basin and individual deflections are used to make inferences of overall pavement conditions. Here are a few parameters to look at when analyzing deflection basins, although there are others:

- As a rule of thumb, the radial distance from the load center to the geophone represents the depth underground to the material that that geophone is measuring. For example, D7 is 48 in. from the load center, and its deflection represents the stiffness of the material that is 48 in. below the pavement surface.
 - By this rule, the D7 deflection is often used to characterize the subgrade, where larger deflections (>4 mils) often correspond to weak and/or moisture related issues subgrades
 - D1 is sometimes used to make inferences to the PMS condition, where larger deflections may indicate weak and/or stripped PMS (> 20 mils).

D1/D7: This ratio can be used to make inferences of the pavement vs. subgrade conditions. For example, a high ratio would indicate a weak pavement on a stiff subgrade, while a low ratio may indicate that a pavement and subgrade are both in good condition.

Other FWD analysis parameters are shown in Exhibit 14-4.

FWD Back-Calculated Pavement Layer Resilient Modulus

The FWD property that is most useful to the pavement designer is the back-calculated layer moduli of each pavement layer and subgrade. Back calculation is a process in which FWD deflections are used to estimate the in-situ *elastic* modulus (E) of each pavement layer. Back calculation is beyond the scope of this manual, but the computational method is available from the NDT Unit.

Note that back calculation estimates the elastic (Young's) Modulus (E), while MDT's and AASHTO's pavement design methods are based upon resilient modulus (M_R). E and M_R are fundamentally different properties, but it is generally

believed that E is correlated to M_R for pavement design purposes. Therefore, back-calculated E needs to be converted to M_R using the following conversion:

$$M_R = E_{FWD} * C$$

Where:

M_R = Resilient modulus for any pavement layer or subgrade to be used for pavement design

E_{FWD} = Pavement layer or subgrade elastic modulus back-calculated from FWD data

C = Conversion factor (Exhibit 14-4)

14.2.2 Ground Penetrating Radar Evaluation

GPR is used to measure in-place PMS thickness. MDT research has concluded that GPR can accurately measure PMS thickness to within 95% accuracy, making it a useful tool for project evaluation (2). See example GPR test results in Exhibit 14-3.

How GPR works: GPR works by sending a tiny pulse of energy into pavement and recording both the time required for the pulse to reflect out of the pavement and the strength of the reflection. These pulses are collected from a vehicle traveling down a road, and the series of pulses over a road produces a scan. The scan can be interpreted to determine the thickness of existing pavement layers and soil layers, and can detect most non-soil objects (utilities, culverts, etc.) below the ground surface within its depth range. The GPR scan can be processed to determine PMS layer thickness, and those thicknesses are often graphed in a Microsoft Excel format (Exhibit 14-3).

MDT's current GPR equipment: The NDT Unit has two pavement testing vehicles (Exhibit 14-1). Each truck is equipped with a 2-GHz and a 400 MHz GPR antennae. These antennas are controlled by a SIR 30 control unit which is connected to a laptop. The 2 GHz antennae are designed to only reach 1 ft. to 1 ½ ft. beneath the pavement surface.

The 400 MHz GPR antennae is able to measure deeper into the pavement section and measure the existing base course thickness.

GPR can be particularly useful for optimizing milling depths and pulverization depth on MDT projects or for any other instance when PMS thickness is needed.

**Exhibit 14-3
Sample GPR Pavement
Thickness Data**

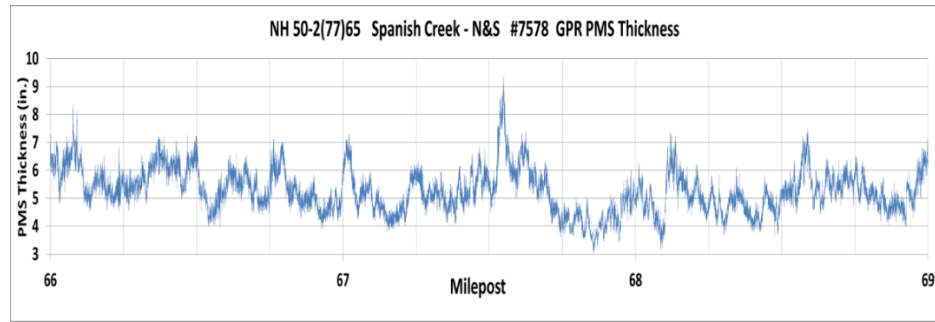

Determining PMS, CAC, CTB, and Subbase Structural Coefficient Based On FWD Elastic Modulus

Guidance within this section can be used to estimate pavement layer structural coefficients based on FWD back-calculated elastic modulus (E), as well as other test results as shown within the following figures.

Back-calculated E must be converted to M_R before using it for pavement design purposes. The designer performs conversion using the conversion factors presented in Exhibit 14-4.

As noted above back-calculated E must be converted to M_R before using it for pavement design purposes. The designer performs conversion using the conversion factors presented in Exhibit 14-4. Structural coefficients and resilient modulus can be related based on the charts provided on pages II-18, II-19, II-21, and II-23 of the 1993 Guide (4, 1993 AASHTO).

It is MDT's policy to use a maximum of 0.33/in for existing PMS surfacing, but the designer should know that this is probably very conservative for polymer modified PMS.

Layer & Material Type	Layer Description	Adjustment Factor, C_{FWD} (M_R/E_{FWD})	
		FHWA Pamphlet	Montana Sites
Aggregate Base Layers	Granular base under a PCC surface	1.32	---
	Granular baes under a CMA layer; semi-rigid pavement	---	0.75
	Granular base above a stabilized material (a Sandwich Section)	1.43	---
	Granular baes under an HMA surface or base	0.62	0.60
Subgrade Soil/Foundation	Soil under a CAM layer; no granular base	---	1.00
	Soil under a semi-rigid pavement with a granular base/subbase	---	0.50
	Soil under a stabilized subgrade	0.75	---
	Soil under a full-depth HMA pavement	0.52	---
	Soil under flexible pavement with a granular base/subbase	0.35	0.50
Cement Aggregate Base Layer	Cement stabilized or treated aggregate layers	---	1.50
HMA Mixtures	HMA surface and base layers; 41°F	1.00	0.90
	HMA surface and base layers; 77°F	0.35	0.60
	HMA surface and base layers; 104°F	0.25	0.50

¹CAM = Cement Aggregate Mix = Cement Treated Base

**Exhibit 14-4
Conversion Factors
for Converting
Back-calculated
Layer Modulus to
Laboratory Equivalent
Resilient Modulus (3)².**

Using GPR to determine existing PMS depths

GPR results such as those shown in Exhibit 14-3 should be used in conjunction with soil survey and core stripping results to determine existing PMS depth for rehabilitation projects. The designer should use the **average** GPR PMS depth for rehabilitation design. The designer should be aware of thinner locations that may warrant further investigation to ensure there is adequate structural integrity to support construction equipment. In situations when GPR data indicates a significant PMS depth change (such as the difference between MP 66.0 and 67.7 and MP 67.8 and 69.0 in Exhibit 14-3), the designer should consult the project manager to consider designing separate rehabilitation typical sections for the differing sections. This may not always be practical and rarely occurs because of the increased complexity of design.

14.2.3 Existing Pavement Sampling and Testing

This section describes how soil survey and PMS curves can be used to estimate pavement layer thickness and condition.

Estimating PMS Structural Coefficient from Core Evaluation

PMS Core evaluation is done in accordance with MT 331, *Method of Sampling and Evaluating Stripping Pavements*. This consists of coring the PMS at 1/2 mile intervals in alternating lanes on two-lanes roads (also 1/2 mile intervals on four-lane roads), measuring the cores, and splitting the cores under indirect tension. The split surface is visually characterized for stripping and scored from 0 to 4 as described

in Exhibit 14-5. The control pictures used for the stripping score test are shown in Exhibit 14-6. Sample results from a past project are shown in Exhibit 14-8. Stripping reports may be distributed in an Excel spreadsheet but are typically always available within Site Manager. Site Manager data may be obtained at the Transport Icon on the Intranet. Using the project UPN, the stripping report (if available) may be found at the following website:

[Project Stripping Report](#)

**Exhibit 14-5
PMS Core Evaluation**

Core Rating	Description
4) Good:	Face shiny, black, all aggregate particles are coated.
3) Moisture Damaged:	Loss of sheen, dull appearance some smaller (-10m) aggregate is uncoated.
2) Stripping:	In addition to moisture damage, some large aggregate is not coated.
1) Severely Stripped:	Most of the aggregate is so clean, the colors of the rock are easily seen.
0) No Core:	Asphalt is mostly gone from all sizes of aggregate. The core has disintegrated.

**Exhibit 14-6
Stripping Score Core Pictures**



(4) Good Core

(3) Moisture Damaged



(2) Stripping

(1) Severely Stripped

(0) Rubble (No Core)

Photo Source: MDT Asphalt Testing Laboratory

Stripping analysis results are useful as explained below:

- Both the total thickness and individual lift thicknesses are provided. This is helpful for determining PMS thickness for structural calculations, or for designing milling and pulverization depths.
- The stripping scores for each lift are useful for determining structural coefficients to calculate SN_{eff} .
- Stripping scores are useful for designing milling depths. Stripping tests can identify poor PMS lifts that should be milled and removed, or ensure that milling operations end in competent plant mix. Past MDT experience has shown that PMS with average stripping scores greater than 1.2 are competent enough to mill into, leaving a stable surface. Milling into PMS with stripping scores less than 1.2 may result in the milled surface being soft, pitted, and too unstable to place new plant mix upon.

Exhibit 14-7 shows guidelines for reducing PMS structural coefficients based on stripping scores. Use the **average** PMS thickness and condition along the project length for rehabilitation design.

Average Stripping Score	Structural Coefficient in. (ft.)
3.0 – 4.0	0.33 (4.0)
1.5 – 3.0	0.27 (3.2)
0 – 1.5	0.20 (2.4)

**Exhibit 14-7
Guidelines for
Adjusting PMS
Structural Coefficients
Based Upon Stripping
Test Scores**

Project: IM 90-2(121)94		Lab#: u35211191153538		10/5/2011					
Termini: Missoula - West		Evaluated By: EP/BW							
Sample #	Description	Core Length (1/10 Ft.)	Rating			Rating			
			Overall	Chip	Top	2nd	3rd	Top	2nd
1	Reserve St. EB on Ramp	0.58	0.02	0.35	0.21		2	1	
2	103.9 EBDL RWP	0.41	0.00	0.18	0.22		2	2	
3	104.4 EBDL RWP	0.42	0.00	0.16	0.26		2	2	
4	104.9 EBDL RWP	0.37	0.00	0.17	0.2		2	2	
5	105.63 EBDL RWP	0.33	0.00	0.16	0.17		2	2	
6	104.15 EBPL LWP	0.46	0.00	0.17	0.29		2	2	
7	10407 EBPL LWP	0.47	0.02	0.18	0.27		2	2	
8	105.36 EBPL LWP	0.49	0.01	0.18	0.3		2	2	

**Exhibit 14-8
Sample Stripping
Analysis Results**

Estimating Base and Subbase Structural Coefficients from Pavement Soil Survey Results

Pavement soil survey results are useful to the pavement designer as follows:

- **Pavement Layer Thicknesses:** Use the average pavement layer thicknesses along the project length for rehabilitation design.
- **Base Course Properties:**
 - **Soil Classification:** Can be used to estimate the amount of subgrade fines that have contaminated the base. MDT has generally used A-1-a(0) crushed gravel for base course, but roads built by other agencies may have used lower quality material. In the past, MDT used base course with up to 12% passing the No. 200 sieve (fines). Since about 2000, the amount of fines has been reduced to 8%. Levels of fines above 12% may indicate base course contamination from the underlying subgrade.
 - **Gradation and Atterburg Limits:** The amount of fines and plasticity index can be used to estimate the resilient modulus and structural coefficient as shown later in this section. As fines increases, the base course weakens and may begin to hold more water.
 - **Natural and Optimum Moisture Content:** The moisture content can indicate the amount of contamination that has occurred. Generally, new base course (CAC) has optimum moisture content from about 5-7%. Optimum moisture contents below 5% and above 8% may indicate a very clean base course or a contaminated base course, respectively.
- **Subgrade Properties**
 - **Soil Classification, Gradation and Atterburg Limits:** This may be the best available indicator of subgrade quality. Appendix D, Exhibit D-7 shows an example of a soil survey. The AASHTO Soil Classification was originally designed to characterize soils for road building, as shown in Exhibit 14-9. Generally, as the amount of fines increases, the moisture sensitivity and strength characteristics of the subgrade increase and decrease respectively. As the Plasticity Limits and Liquid Limit increase, its ability to hold moisture increases while constructability decreases.

Exhibit 14-9 AASHTO Soil Classification System

TABLE 1-8 AASHTO SOIL CLASSIFICATION SYSTEM

General Classification	Granular Materials (35 % or less passing No. 200)							Silt-Clay Materials (More than 35 % passing No. 200)			
	A-1		A-3	A-2				A-4	A-5	A-6	A-7
	A-1-a	A-1-b		A-2-4	A-2-5	A-2-6	A-2-7				A-7-5, A-7-6
Sieve analysis, percent passing:											
No. 10 (2.00 mm)	50 max
No. 40 (425 μm)	30 max	50 max	51 min
No. 200 (75 μm)	15 max	25 max	10 max	35 max	35 max	35 max	35 max	36 min	36 min	36 min	36 min
Characteristics of fraction passing No. 40 (425 μm):											
Liquid limit	40 max	41 min	40 max	41 min	40 max	41 min	40 max	41 min
Plasticity index	6 max	N.P.	N.P.	10 max	10 max	11 min	11 min	10 max	10 max	11 min	11 min ^A
Usual types of significant constituent materials	Stone fragments, gravel and sand		Fine sand	Silty or Clayey Gravel and Sand				Silty Soils		Clayey Soils	
General rating as subgrade	Excellent to good							Fair to poor			

^APlasticity index of A-7-5 subgroup is equal to or less than *LL* minus 30. Plasticity index of A-7-6 subgroup is greater than *LL* minus 30.

Reprinted with permission of American Association of State Highway and Transportation Officials.

This page intentionally left blank.

- **Natural and Optimum Moisture Content:** The designer should evaluate whether the natural water content is greater than the optimum water content. When this occurs, it indicates that the subgrade is soft and may not support construction equipment, and that fines may pump into the base course.
- **Maximum Dry Density:** Generally, as this amount increases, the soil quality for roadbuilding increases. This property ranges from 80 – 145 lbs./cubic ft., where 80 lbs. indicates plastic clay that will hold water and 145 lbs. indicates very dense, drainable gravel.

The existing base or subbase structural coefficient can be estimated using the following equation from NCHRP 1-37a (5):

$$M_{R(\text{Base})} = 2555 * (75 / (1 + 0.00728 * \text{PI} * \text{P200}))^{0.64}$$

Where:

Maximum $M_{R(\text{Base})}$ = 29,000 psi

$M_{R(\text{Base})}$ = Resilient Modulus of the unbound base or subbase course (psi)

PI = Plasticity Index (%)

P200 = Percent Passing the No. 200 Sieve (%)

Use the **average** $M_{R(\text{Base})}$ along the project length to determine the structural coefficient for pavement design using Exhibit 14-6. The structural coefficients provided in **Error! Reference source not found.** should be used unless otherwise approved by the pavement analysis engineer.

Estimating CTB Structural Coefficient

Estimating the structural coefficient of existing CTB is difficult, particularly on thinner pavements. To separate the PMS and CTB layers for back calculation is difficult: laboratory testing requires removing an intact CTB core for unconfined compression testing, which MDT does not do.

Fortunately, testing data from prior CTB projects is available to assist designers. Exhibit 14-10 shows historical CTB compressive testing results. The figure shows that the average CTB is about 550 psi, which corresponds to a structural coefficient ~0.18. Based on this, 0.18 is considered to be a good starting point for estimating a CTB structural coefficient. The designer can reduce or increase the coefficient if he/she has better information regarding CTB quality and strength on a given project. The current specification requires CTB to achieve a 7-day compressive strength between 500-1500 psi. The structural coefficients provided in **Error! Reference source not found.** should be used unless otherwise approved by the pavement analysis engineer.

**Exhibit 14-10
CTB 7-day Compressive
Strength Test Records
2001-2011**

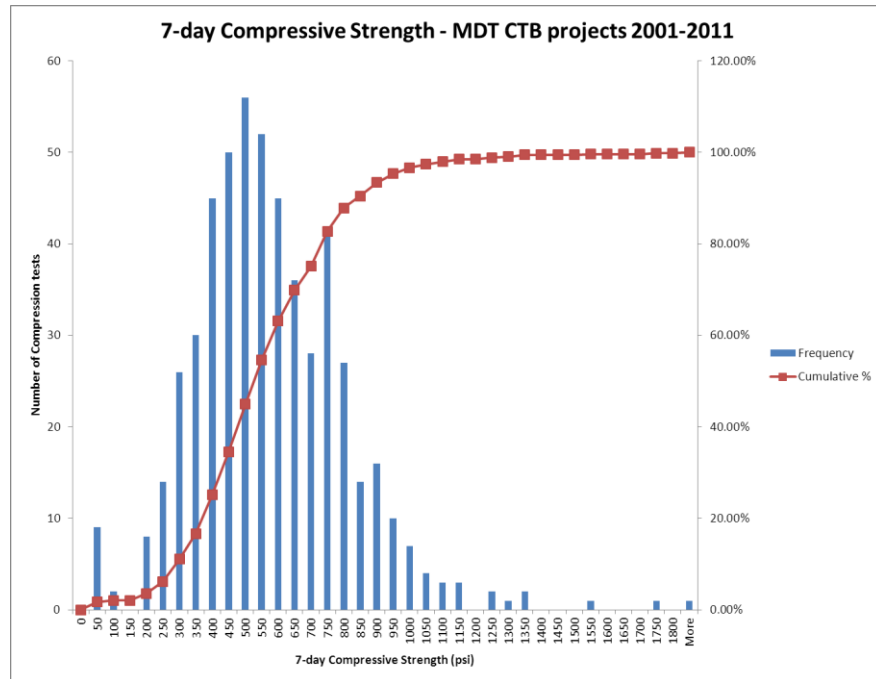

14.3 ADDITIONAL PAVEMENT ANALYSIS TOOLS

PathWeb is the current version of the road image viewer. This viewer contains information such as image data, rut, ride, surface rendering, GPS map and transverse profile for all Interstate, National Highway System (NHS), Primary, Secondary and some urban routes. PathWeb may not be available without MDT Network access or to external design consultants. PathWeb is available at the following website:

[PathWeb](#)

The ride and rut links annual treatment and condition reports are available at the following website:

[Ride and Rut Information](#)

Agile Assets is the comprehensive pavement management tool used by the Pavement Management Unit. Contact the pavement management supervisor at (406) 444-6149 for more information.

Path View is an image viewer that is similar to PathWeb and accesses data from a share drive. This viewer provides additional information such as:

- Actual mile posts
- Cross slope
- Rut depth
- GPS coordinates

Contact the pavement management supervisor at (406) 444-6149 for more information.

For more information can be found at the following website for the MDT Pavement Analysis Section:

[MDT's Pavement Analysis Section](#)

Additional resources regarding surfacing options can be found at the following website:

[Additional Resources](#)

Also, additional resources for surfacing options can be found at the following website:

[Research Link](#)

14.4 REFERENCES

1. MDT. Non-Destructive Testing Manual. MDT, Helena, MT, 2018.
2. Maser, Keneth R. Ground Penetrating Radar (GPR) Analysis: Phase II Field Evaluation. MDT, Helena, MT 2011.
3. VonQuitus. Mechanistic-Empirical Pavement Design Guide Flexible Pavement Performance Prediction Models for Montana. MDT, Helena, MT, 2007.
4. AASHTO. Guide for Design of Pavement Structures. AASHTO, Washington D.C., 1993.
5. TRB, ARA, Inc., ERES Consultants Division. NCHRP 1-37A, Guide for Mechanistic-Empirical Design of New and Rehabilitated Pavement Structures. TRB, Washington, D.C., 2004.

MONTANA DEPARTMENT OF TRANSPORTATION

PAVEMENT DESIGN MANUAL

Chapter 15

Pavement Economic Analysis

November 2018



Contents

CHAPTER 15 PAVEMENT ECONOMIC ANALYSIS.....15-1

15.1 Introduction.....	15-1
15.2 Project Selection	15-1
15.3 LCCA Terminology.....	15-2
15.3.1 LCCA Process:	15-3
15.3.2 Additional Resources:.....	15-4
15.4 References	15-4



Chapter 15

Pavement Economic Analysis

15.1 INTRODUCTION

A life cycle cost analysis (LCCA) consists of calculating initial construction costs, future maintenance costs over the LCCA analysis period, and remaining life or salvage value at the end of the analysis period. Based on these calculations, the relative value of each option is determined based on their net present value. MDT does not currently factor user costs in the analysis.

When deemed necessary to perform an LCCA, a copy should be distributed with the surfacing design memorandum created under Activity 600 (Prepare Preliminary Surfacing Typical Section).

LCCAs are typically performed when comparing concrete to plant mix. Currently, MDT uses a design life of 30 years for concrete and 20 years for plant mix. A 30-year design life for plant mix should be considered with an adjusted maintenance cycle. A 40-year design life for concrete should be considered in the instances when the minimum typical section will provide that life. The design life is the length of time for which a pavement structure is being designed based on structural distresses and traffic loadings.

MDT currently uses the Net Present Value (NPV) method for LCCA.

15.2 PROJECT SELECTION

A life cycle cost analysis (LCCA) comparing different pavement alternatives should be performed any time there might be economic savings for a project when considering long-term construction cycles. In practice, it is typically only necessary to do a LCCA on a project that meets all of the following characteristics (or by request from the District or Road Design):

- Project Scope of Major Rehabilitation or Reconstruction
- High Daily ESALs (plant mix thickness \geq 0.40 ft.)
- Substantial Project Length
- Width \geq 40 ft.

15.3 LCCA TERMINOLOGY

Analysis Period is the service life of the pavement considered in the economic analysis. An analysis period of 40 years or more should be used.

Initial Design Period is the service life of the reconstructed pavement that does not include subsequent pavement preservation or rehabilitation.

The outputs of this analysis include:

Initial Pavement Construction Cost is the cost of initial construction of the pavement. This cost includes pavement related bid items, mobilization, traffic control, and construction engineering. Similar items required in all design options (e.g., striping) are not considered since the cost differences are insignificant.

Maintenance Cycle and Costs includes both the predicted year and cost of future maintenance activities. These costs may be calculated using the cost/yard² prices within the PvMS Annual Report. The PvMS costs include both mobilization and traffic control. A 10% cost factor should be added to account for Construction Engineering (CE).

The PMS options may include:

- A chip seal scheduled for year 7
- An overlay or mill/fill scheduled for year 14
- A chip seal scheduled for year 21
- A minor rehabilitation (overlay or mill/fill) scheduled for year 28
- A chip seal scheduled for year 35
- A major rehabilitation at year 42
- A chip seal scheduled for year 49
- An overlay or mill/fill scheduled for year 56
- Salvage value at year 60 for the remaining service life

The concrete options may include:

- A diamond grind, joint seal, and slab replacement (~2%) at year 20
- A diamond grind, joint seal, and slab replacement (~2-5%) at year 40
- Salvage value at year 60 for the remaining service life

Net Present Value (NPV) is the discounted cost of initial construction, maintenance activities, and salvage value of the pavement option during the LCCA period. Future maintenance activities and salvage value are discounted to today's dollars using the discount rate. In simpler terms, NPV is the amount of money MDT would have to invest in treasury bonds today to pay for all construction activities within the pavement's life cycle analysis period minus the salvage value. The pavement option with the lowest NPV is considered the best value.

C-Factor is used to “level the playing field” between alternate pavement sections (most often PMS vs. PCCP). The C-Factor is a cost adjustment added to the least expensive option’s bid (usually PMS) to account for the decreased life cycle costs associated with pavement options with higher initial costs (usually PCCP). The C-Factor is calculated as follows:

$$\text{PCCP pavement NPV} - \text{PMS pavement NPV} = \text{C-Factor}$$

Some additional LCCA terminology is as follows:

Remaining Life/Salvage Value: For pavement LCCA, it is necessary to compare pavements with a different length of service life. In these cases, an additional cost is subtracted during the LCCA’s last year to account for either remaining service life or the pavement’s salvage value. An example of this is the salvage value of a failed concrete pavement which can still serve as a base for a crack & seat and overlay project.

Discount Rate is the real rate of return that can be expected on a conservative, long-term investment. For pavements, the discount rate is calculated as follows:

$$30\text{-year Treasury Bond Rate} - \text{Average Rate of Inflation} = \text{Discount Rate}$$

The official discount rate (real interest rate not nominal) published by the White House Office of Budget and Management (OBM circular A-94).

15.3.1 LCCA Process:

The Pavement Design Engineer will perform the LCCA process as follows:

1. Perform a pavement design for concrete and PMS options.
2. Establish project parameters including quantities, length, and width.
3. Work with the Road Design to identify unique project constraints such as grade limitations due to approaches, structures, curb and gutter, and hydraulic features. Project constraints will dictate the types of future rehabilitations that are possible.
4. Identify maintenance cycles associated with the analysis period for each option.
5. Quantify user costs if considered.
6. Determine materials cost based on project quantities and project location. Verify costs with the respective District construction personnel and the engineering cost analyst.
7. Calculate the Net Present Value of each option.

8. Summarize the LCCA in a brief report and distribute with the Activity 600 memorandum.

15.3.2 Additional Resources:

A more comprehensive description of LCCAs can be found in the following additional resources:

[NCHRP Report 703 - Guide for Pavement-Type Selection](#)

[FHWA Technical Advisory Use of Alternate Bidding for Pavement Type Selection](#)

[FHWA Transportation Performance Management](#)

15.4 REFERENCES

No references were identified for this chapter.

MONTANA DEPARTMENT OF TRANSPORTATION

PAVEMENT DESIGN MANUAL

Appendices

November 2018



Appendix A

Sample Traffic Memorandum

**Montana Department of Transportation
Helena, Montana 59620**

Memorandum

To: Bryce Hove
Great Falls Design

From:  Becky Duke, Supervisor
Traffic Data Collection & Analysis Section

Date: January 10, 2013

Subject: STPP 3-2(64)60
Pendroy – N & S
Control No. 4051003

Attached is the traffic information requested in an email dated December 21, 2012. There are no major traffic breaks within the project. Please note that the equivalency factors used to calculate ESAL values are determined using information from our weigh-in-motion sites and reflect a five-year average.

If you have any questions or need further assistance, please contact me at 6122.

CC: Ed Shea, Pavement Analysis and Research - Helena
Project File

RAIL TRANSIT AND PLANNING DIVISION
DATA COLLECTION SECTION
Worksheet for Engineering and Planning Purposes

Project Description: Minor Flexible
 STPP 3-2(64)60
 Pendroy - N & S
 Control No. 4051003
 S-219: West of US 89/P-3

*Truck Distribution**

Date: 10-Jan-13

<u>2012</u>	AADT= <u>260</u>	PRESENT		5	20.0 %	3.7 %
				6	12.0 %	2.2 %
				7	0.0 %	0.0 %
<u>2015</u>	AADT= <u>270</u>	LETTING YEAR		8	4.0 %	0.7 %
<u>2035</u>	AADT= <u>350</u>	DESIGN YEAR		9	34.0 %	6.3 %
	DHV= <u>50</u>			10	30.0 %	5.5 %
	D= _____			11	0.0 %	0.0 %
	T= <u>18.5%</u>			12	0.0 %	0.0 %
	EAL= <u>23</u>			13	0.0 %	0.0 %
	AGR= <u>1.3%</u>					
					100.0 %	18.5 %

2012

AADT*= <u>260</u>	
BUS= <u>0.4%</u>	1
COM= <u>18.5%</u>	48
FUT= <u>1.3%</u>	
DHV= <u>14.00%</u>	

* Distribution: Preliminary 2012 Vehicle Class Count (Site ID: 50-1-4)

* AADT and Growth Rate: Preliminary 2012 TYC

PROJECT DESCRIPTION: STPP 3-2(64)60 DATE: 10-Jan-13 RIGID: X
 Pendroy - N & S FLEXIBLE: X
 Control No. 4051003 PAVEMENT:

LETTING YEAR AADT: 270 LETTING YEAR 2015 LANE DESIGN FACTOR: 100 %
 DESIGN YEAR AADT: 350 DESIGN YEAR 2035

VEHICLE TYPE	% OF TYPE	LETTING YEAR ADT	DESIGN YEAR ADT	MEAN YEAR ADT	DIRECTIONAL ADT	DESIGN LANE ADT	18K EQUIV RATE FAC	MEAN YEAR ADL
CLASS 1 & 2	39.1	105.57	136.9	121.2	60.6	60.6	0.001	0.06
CLASS 3	42.1	113.67	147.4	130.5	65.3	65.3	0.007	0.46
CLASS 4	0.4	1.04	1.3	1.2	0.6	0.6	0.669	0.40
CLASS 5	3.7	9.97	12.9	11.4	5.7	5.7	0.143	0.82
CLASS 6	2.2	5.98	7.8	6.9	3.4	3.4	0.498	1.71
CLASS 7	0.0	0.00	0.0	0.0	0.0	0.0	0.829	0.00
CLASS 8	0.7	1.99	2.6	2.3	1.1	1.1	0.378	0.43
CLASS 9	6.3	16.95	22.0	19.5	9.7	9.7	1.115	10.85
CLASS 10	5.5	14.95	19.4	17.2	8.6	8.6	1.003	8.61
CLASS 11	0.0	0.00	0.0	0.0	0.0	0.0	0.777	0.00
CLASS 12	0.0	0.00	0.0	0.0	0.0	0.0	0.877	0.00
CLASS 13	0.0	0.00	0.0	0.0	0.0	0.0	1.492	0.00
CLASS 14	0.0	0.00	0.0	0.0	0.0	0.0	0.00	0.00
CLASS 15	0.0	0.00	0.0	0.0	0.0	0.0	0.00	0.00
CLASS 16	18.5	49.85	64.6	57.2	0.0	0.0	0.00	0.00
TOTAL VALUES	100.0							23.34

AVERAGE DAILY 18 KIP EQUIVALENT AXLE LOAD: 23.34
 20 YEAR EQUIVALENT AXLE LOAD: 170,351

2012 AADT = 260
 2015 AADT = 270
 2035 AADT = 350
 DHV = 50
 Direction =
 Com Trks = 18.5%
 ESAL = 23.34
 AGR = 1.260%

* Equivalency Factors: WIM Data (2007 to 2011)



Appendix B

Example Surfacing Design

Memorandum



Montana Department of Transportation
PO Box 201001
Helena, MT 59620-1001

Memorandum

To: Lesly Tribelhorn, PE
Highways Engineer

Thru: Jim Davies, PE *JJD*
Pavement Analysis Engineer

From: Greg Zeihen, PE *GZ*
Pavement Research Engineering Specialist

Date: September 5, 2018

Subject: HSIP 1033(2)
SF 149 Hillcrest Rt Turn
UPN 8904
Work Type – 310 roadway and Roadside Safety Improvements
Surfacing Design Activity 600

The PRELIMINARY surfacing section for this project is listed below. **This recommendation completes Surfacing Design Activity 600.**

Reconstruction/ Right Turn Lane

Surfacing Section No. 1

0.30' Plant Mix Bituminous Surfacing, Grade S

1.60' Crushed Aggregate Course

1.90'

Design R value = 5

Reconstruction/ Right Turn Lane

Surfacing Section No. 2

0.30' Plant Mix Bituminous Surfacing, Grade S

0.65' Crushed Aggregate Course

0.95'

Design R value = 30

2.00' Special Borrow

Recommendation surfacing section design life is 20 years, in accordance with AASHTO design procedures. Grade S ¾" plant mix surfacing with PG 64-28 binder and 5.3% asphalt content are recommended. PG Binder and grade were determined as per April 7, 2005 Materials Bureau policy memorandum. PG 70-28 may be substituted at the district's discretion.

Surfacing design is based on 112 ESALs as cited within the 3/22/18 MDT Traffic Memo. Design Resilient Modulus = 30,000 psi for placement of 2.00' of special borrow meeting or exceeding an R-value of 30, and 3,250 psi for subgrade. Other parameters are Delta PSI = 1.7, Standard Deviation = 0.45, and Reliability = 75%.

Surfacing Design Activity 600

SF169 S288 Curves, UPN 9380

Page 2 of 2

Separation geotextile should be placed between crushed aggregate base/special borrow and subgrade to prevent infiltration of fines into the base.

Please contact Greg Zeihen or Jim Davies with questions regarding this recommendation.

E-Distribution:

Stefan Streeter, District Administrator

James Combs, Highways Design Engineer

Damian Krings, Road Design Engineer

Kurtis Schnieber, Design Project Manager

Rod Nelson, District Preconstruction Engineer

Kurtis Schnieber, District Projects Engineer

Cameron Kloberdanz, District Geotechnical Manager



Appendix C

Memorandum Naming Convention & Saving Procedure

UPLOADING SURFACING DESIGN MEMOS TO DMS

\\mdthq\mdtshares\helena\PavementAnalysis\SurfacingDesign\Pavement_Design_Manual\Appendix 1-Upload memos to DMS.docx

After receiving the .pdf version of the memorandum, rename it according to the following convention:

9103000SDXXX00X.pdf

The first seven digits are the UPN number, including splits (i.e. 9103001), the next two digits represent Surfacing Design (SD), the next XXX indicates Surfacing activity (PSS, FSS, FSC), and the 00X represents revisions.

XXXXXXXXSDPSS001, 002, 003 etc. = Activity 600 memo and revisions

XXXXXXXXSDFSS001, 002, 003 etc. = Activity 604 memo and revisions

XXXXXXXXSDFSC001, 002, 003 etc. = Activity 610 memo and revisions

Place it in the C:DGN file.

Give yourself permission to upload the file to DMS.

Open DMS and you will see this page:

Document Management System - Gregory Zeihen(OPSSU0096)@E

[Add New Document\(s\)](#)

[Applications Search](#)

[Document Classes Search](#)

[DMS Directories Search](#)

[Document Information Search](#)

[Document Notifications Search](#)

[Document Type Search](#)

[Project Search](#)

[Reference Documents Search](#)

[Reference By Documents Search](#)

[Request Status Search](#)

[Server Documents Search](#)

[User Documents Search](#)

[Users Search](#)

[Workgroups Search](#)

[Workgroup Phases Search](#)

[DMS Directories vs Project Numbers](#)

Comments, questions, problems or concerns? Please email the [DMS Administrators](#) or a [DMS Contact](#).

[DMS Users Manual](#)

[DMS File Restore](#)

[DMS File Naming Standards](#)

[DMS Cross Reference Naming Standard](#)

[DMS Workgroup Security Officer Manual](#)

[DMS Contacts](#)

Click “User Search” in the left column and you will see this page:

Enter your User Id (UXXXX) in the upper right box. Change the Add Privilege(s) box to 1.

Click on the drop down arrow on the end of the DMS Directory box, and you will see this page:

Enter the UPN number in the Project box on the upper left (do not forget to include the 001 if it is a split) and press the search button, which will lead you to the next page. Select one of the projects, which will become highlighted, and press the retrieve button on the bottom.

Next, go to the Workgroup box dropdown arrows and select SD-SURFACE DESIGN, and your screen will look like this:

Press the search button on the bottom, and you will see the following screen:

User Name	User Id	Phone	Location	Termination Date	Active	Supervisor 01	Supervisor 02	Request Activity
DMS Directory	Workgroup	Privilege						Request Activity
New User DMS Directory Privileges								
DMS Directory	Workgroup	Privilege	User Name	Request Activity				
		Read						Insert

Using the drop-down arrows, fill in the DMS Directory, the Workgroup, and the User Name boxes, and change the Privilege box to write. Click the retrieve button at the bottom, and this screen will appear.

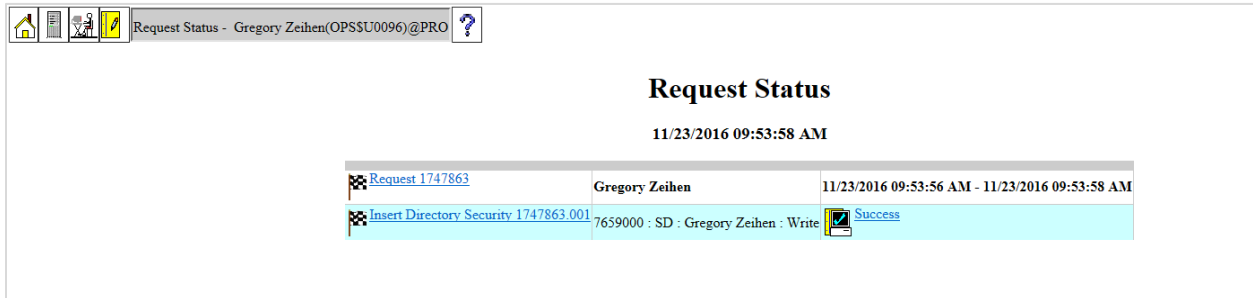

Click the home key at the upper left, and select “Add New Document” and you will see this screen:

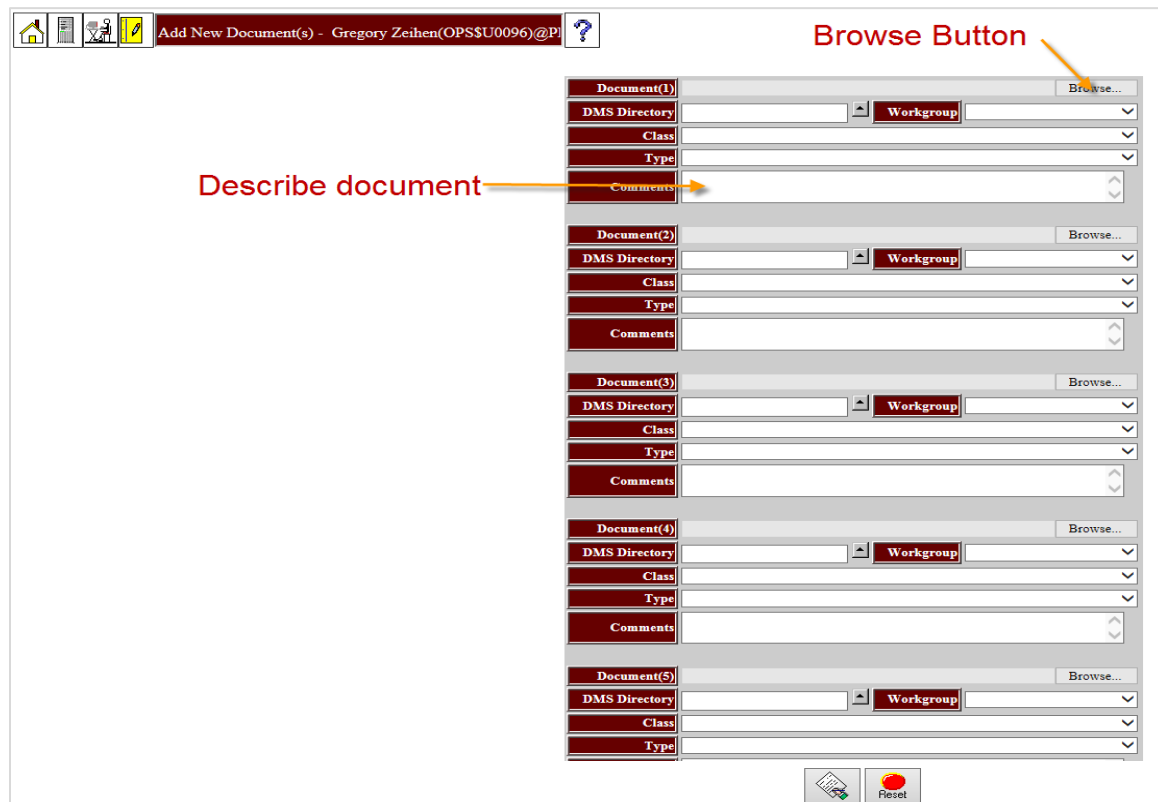

Load your memorandum from the DGN file using the Browse Button, and all the fields should automatically populate. Type in the description (e.g., Preliminary Surfacing Design Recommendation – 600 Activity), and click the retrieve button on the bottom. Your document should now be uploaded. Check by retrieving it.

Document Size	Request Activity	Include References	Request Notification	DMS Directory	Class
				Workgroup	Application Type
8790000GTGDM460.PDF 1,125.5 kb	<input type="radio"/> None <input type="radio"/> View		<input type="radio"/> None <input type="radio"/> Document	8790000 GT	Geotechnical Design Memo Acrobat: Portable Document Format Created on 11/03/2016 02:21:57 PM by Patrick Mccann(U0340) Activity 460 - Preliminary Geotechnical Evaluation Report
8790000RDPFR005.PDF 479.7 kb	<input type="radio"/> None <input type="radio"/> View		<input type="radio"/> None <input type="radio"/> Document	8790000 RD	Preliminary Field Review Acrobat: Portable Document Format Created on 04/29/2016 09:32:29 AM by Michael Degenstein(U4949) Signed PDF
8790000RDPLP001.PDF 7,813.2 kb	<input type="radio"/> None <input type="radio"/> View		<input type="radio"/> None <input type="radio"/> Document	8790000 RD	Plan & Profile Sheets Acrobat: Portable Document Format Checked In on 03/18/2016 06:53:40 AM by Michael Degenstein(U4949) Title, Plan & Profile for preliminary discussion
8790000RDPXS001.PDF 11,157.8 kb	<input type="radio"/> None <input type="radio"/> View		<input type="radio"/> None <input type="radio"/> Document	8790000 RD	Preliminary Cross Sections Acrobat: Portable Document Format Checked In on 03/18/2016 06:53:42 AM by Michael Degenstein(U4949) Proposed Cross Sections for preliminary discussion
8790000RDSRF001.PDF 2,350.8 kb	<input type="radio"/> None <input type="radio"/> View		<input type="radio"/> None <input type="radio"/> Document	8790000 RD	Surfacing Acrobat: Portable Document Format Checked In on 03/18/2016 06:53:43 AM by Michael Degenstein(U4949) Survey request sent 2-25-15
8790000ROPEO001.PDF 17,631.7 kb	<input type="radio"/> None <input type="radio"/> View		<input type="radio"/> None <input type="radio"/> Document	8790000 RO	Preliminary Engineering Ownership Report Acrobat: Portable Document Format Created on 08/02/2016 12:56:52 PM by Justin Crow(U2573) Ownership Study
8790000ROROE001.PDF 14,023.6 kb	<input type="radio"/> None <input type="radio"/> View		<input type="radio"/> None <input type="radio"/> Document	8790000 RO	Right of Entry Acrobat: Portable Document Format Created on 05/29/2015 07:11:02 AM by Justin Crow(U2573)
8790000SDSRF001.PDF 302.6 kb	<input type="radio"/> None <input type="radio"/> Check Out <input type="radio"/> Delete <input type="radio"/> View		<input type="radio"/> None <input type="radio"/> Document	8790000 SD	Surfacing Acrobat: Portable Document Format Voided on 11/28/2016 08:30:32 AM by Gregory Zeihen(U0096) Preliminary Surfacing Recommendation Act. 600
8790000SDSRF001.PDF	<input type="radio"/> None		<input type="radio"/> None	8790000	Control Survey

NOTE: When retrieving the document, be sure to check the “view” button and not the “check out” button or you will have checked out the document, and you will receive late notices from Workflow Mailer.

Additional information can be found by clicking the DMS Workgroup Security Officer Manual link on the home page:

Document Management System - Gregory Zeihen(OPSSU0096)@PR

[Add New Document\(s\)](#)
[Applications Search](#)
[Document Classes Search](#)
[DMS Directories Search](#)
[Document Information Search](#)
[Document Notifications Search](#)
[Document Type Search](#)
[Project Search](#)
[Reference Documents Search](#)
[Reference By Documents Search](#)
[Request Status Search](#)
[Server Documents Search](#)
[User Documents Search](#)
[Users Search](#)
[Workgroups Search](#)
[Workgroup Phases Search](#)

[DMS Users Manual](#)
[DMS File Restore](#)
[DMS File Naming Standards](#)
[DMS Cross Reference Naming Standard](#)

[DMS Directories vs Project Numbers](#)
 Comments, questions, problems or concerns? Please email the [DMS Administrators](#) or a [DMS Contact](#).

[DMS Workgroup Security Officer Manual](#)
[DMS Contacts](#)

When adding the link to DMS in the e-mail distribution, use the following address:

<\\astro\USR1\XXXX000\SD\XXXX000SDYYY00X.PDF>

Where the first two sets of Xs=the UPN number, the Ys represent either PSS, FSS, or FSC for the various 600 activities, and the last X represents the revision.



Appendix D

Flexible Pavement

Rehabilitation Design Example

The following design example summarizes the design of a major rehabilitation pavement section for the Alberton E. and W. project. This is a high-traffic Interstate, and the example summarizes a pavement design using the DARWin software. The following information presents a summary of items that may affect the pavement design:

Project Name:	Alberton E. and W.
Project Number:	IM 90-1(196)74
Construction Number (CN):	7523
Existing Surface:	0.2' PMS 0.15-0.30' Hot Recycled PMS 0.15-0.2' CTS 1.25'-1.50' CAC
Project Limits:	RP 74.4 – 84.0
Project Type:	Major Rehabilitation without Added Capacity
District:	Missoula
Geographic Province:	Rolling Terrain - Rural
Weather/Climate:	Moderate Precipitation, Multiple Freeze-Thaw During Spring and Fall, frozen during winter
Traffic information:	Daily ESALs = 1104
	Daily AADT (Average Annual Daily Traffic) = 7,090
Soils:	Mostly Gravel
	FWD Subgrade Lab M_R = 12,000 psi

Step 1: Determine Pavement Rehabilitation Method

This pavement is in poor condition. The District has decided that this pavement needs major rehabilitation because the Maintenance Division was spending a lot of time and money to maintain the roadway.

The road was reconstructed between 1963 and 1979 (projects I-90-1(17), I-90-1(70), I-90-2(51) and I-90-2(21)). In 1998, an overlay and chip seal was applied to the roadway under project IM 90-1(119)74. In 2006, another chip seal was applied under project SFCI 90-1(156)74.

A key design feature on this project is that the vertical grade cannot be raised.

Core samples have been obtained from the MDT Missoula District Materials. Exhibits D-1 and D-2 provide a summary of the existing surfacing depths.

I-90 Mainline

Location	Surfacing Depth Range	Surfacing Depth Average
Driving Lane	0.58' – 1.05'	0.77'
Passing Lane	0.55' – 0.99'	0.75'
Driving Lane Shoulder	0.34' – 0.94'	0.72'
Passing Lane Shoulder	0.55' – 0.99'	0.75'

**Exhibit D-1
Existing Surface
Depths on I-90
Mainline**

I-90 Interchange Ramps

Location	Surfacing Depth Range	Surfacing Depth Average
Exit 75 (Alberton)	0.56' – 0.76'	0.61'
Exit 77 (Petty Creek)	0.38' – 0.46'	0.42'
Exit 82 (Nine Mile)	0.60' – 0.65'	0.62'

**Exhibit D-2
Existing Surface
Depths on I-90
Interchange Ramps**

All of the cores exhibited stripping in both the top and bottom layers (65 of the 83 cores had a severely stripped top layer).

The first step is to determine what the pavement distress is and what is causing it. At the PFR, it is noted that there is potholing extending 2-4 in. into the PMS and raveling within the wheel paths. There does not appear to be rutting or alligator cracking. Based on that, the pavement appears to be structurally okay, and the problem may be within the PMS layer.

A PMS core evaluation was provided by the Helena Materials lab. A sample of the core report is shown in Exhibit D-3. The core report shows that there is moderate to severe PMS stripping occurring throughout the depth of the PMS.

Sample#	Description	Overall	Core Length (mm)						Rating:				
			Chip	Top	2nd	3rd	4th	5th	Top	2nd	3rd	4th	5th
61	RP 80 WB DL SH	0.62 BB	0.03	0.22	0.18				1	2	1		
62	RP 80.5 WB PL	0.96	0.03	0.20	0.20	0.20	0.13		1	2	2	2	2
63	RP 80.5 WB PL SH	0.93	0.02	0.20	0.20	0.15	0.14	0.22	1	2	1	1	1
64	RP 81 WB DL	0.88	0.02	0.26	0.20	0.28	0.12		1	2	1	2	
65	RP 81 WB DL SH	0.73	0.02	0.18	0.15	0.21	0.17		1	2	1	1	
66	RP 81.5 WB DL	0.85	0.02	0.30	0.17	0.36			1	3	2		
67	RP 81.5 WB DL SH	0.72	0.02	0.18	0.17	0.15	0.20		1	3	2	2	
68	RP 82 WB DL	0.60	0.01	0.30	0.15	0.14			1	2	1		
69	RP 82.25 WB PL	0.74	0.03	0.15	0.22	0.34			1	2	1		
70	RP 82.5 WB DL SH	0.60	0.03	0.28	0.15	0.14			2	2	1		
71	RP 83 WB PL	0.72	0.03	0.16	0.20	0.33			2	2	1		
72	RP 83.5 WB DL	0.58	0.02	0.14	0.23	0.19			1	3	1		
73	RP 84 WB PL	0.74	0.02	0.15	0.22	0.35			2	2	1		
74	RP 84 WB DL	0.72											
75	RP 84 WB DL SH	0.65	0.03	0.22	N/A	N/A			2	0	1		
76	RP 84 WB PL SH	0.67	0.01	0.17	0.33	0.16			2	2	1		
77	EX 75 EB ON RAMP	0.76	N/A	N/A	N/A	0.18			0	0	1		
78	EX 75 EB OFF RAMP	0.56	0.02	0.20	0.20	0.14			1	1	1		
79	EX 75 WB ON RAMP	0.56	0.02	0.28	0.26				1	1			
80	EX 75 WB OFF RAMP	0.56 BB	0.02	0.19	0.22	0.13			1	1	1		

**Exhibit D-3
Sample Core Report**

Code Rating 4 = Good 3 = Moisture Damaged 2 = Stripping 1 = Severely Stripped 0 = No Core

The NDT Unit provided GPR and FWD summarizing both the thickness and quality of the pavement layers, as shown in Exhibits D-4, D-5 and D-6.

**Exhibit D-4
Information from NDT
Unit**

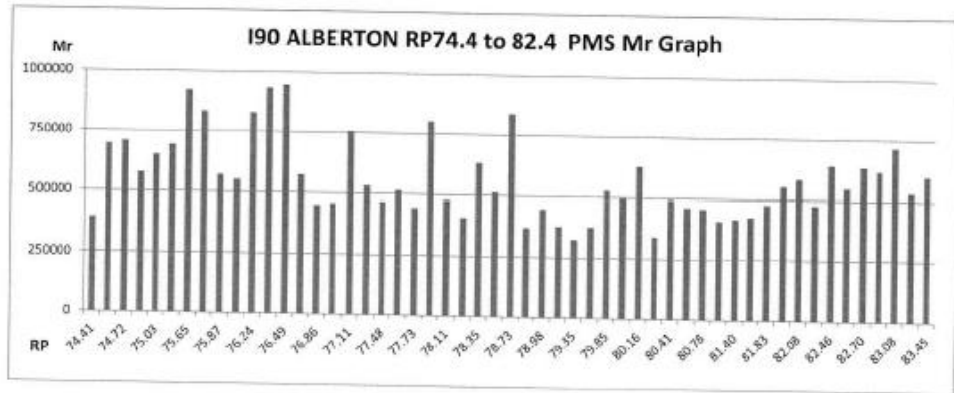

**Exhibit D-5
Information from NDT
Unit**

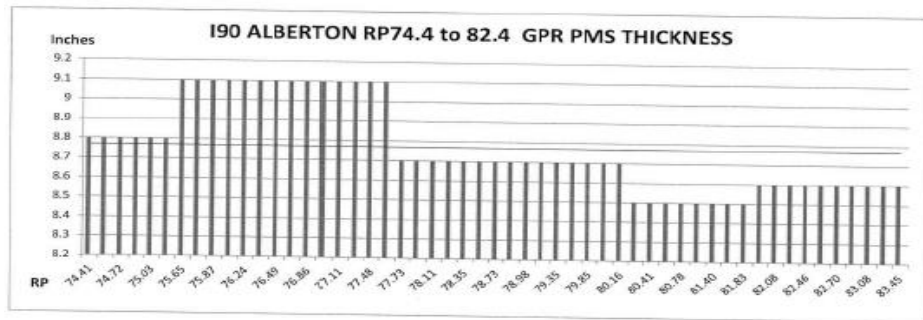

**Exhibit D-6
Information from NDT
Unit**

I90 Alberton RP 74.4 to 84.2

WB			
19-AUG-08	PMS	BASE	SUB
Average	568440	88370	26766
Std. Dev.	157352	29024	8423
Corrected	458294	68053	20870
Lab	255798	54789	13383
	8.77"	15.38"	

The FWD Moduli summaries above indicate that the PMS Mr is low. The PMS lab Mr is 255,798 psi, which is low for a heavily trafficked Interstate pavement. The GPR information shows the PMS thickness range from 8.5 to 9.1 in.

Soil Survey information was collected by the District for the base course to identify whether or not the base is in good condition. This information is shown in Exhibit D-7:

Exhibit D-7 Soil Survey

Lab Form No. 111/Q/MT-STD/F111.doc
Revised 2/10/2004

**Montana Department of Transportation
Preconstruction Soil Survey Data
and Special Recommendations Relative to Subgrade and Road Surface Design**

Project Number IM 15-4(137)222 [7617] Project Name Wolf Creek N&S Length 7.9 Miles County Lewis & Clark Date 10-1-12
Submitted by Stan Kuntz Title DMS Stan Kuntz Steve Prinzing
District Materials Supervisor District Eng. Svcs. Supervisor

Hole Number	Sample Number	Date	Reference to Centerline – Location of Boring	Depth	Representing Stationing	Soil Class (MT214)	LL	PI	10 Mesh (2.00 mm)	40 Mesh (.425 mm)	200 Mesh (.075 mm)	In Place Density	Specific Gravity	Density Maximum Dry	Moisture Percent Natural	Moisture Percent Optimum	Water Table Depth to	(AASHTO T190) "R" Value
9		9/27/12	10.0' RT SB	0.0-0.55'	MM 225.0	Oil Mat												44
9	1			0.55-1.65'	Base	A-1-b(0)	NP	NP	44	27	16.0							72
9	2			1.65-7.5'	Subgrade	A-1-a(0)	NP	NP	38	22	12.6			139.9	4.6	7.8		
10		9/27/12	10.0' RT SB	0.0-0.9'	MM 224.58	Oil Mat												37
10	1			0.9-2.0'	Base	A-1-a(0)	NP	NP	37	22	12.4							72
10	2			2.0-5.0'	Subgrade	A-1-a(0)	NP	NP	25	14	8.2			Too Rocky	2.7			
11		9/26/12	10.0' RT SB	0.0-0.9'	MM 224.19	Oil Mat												32
11	1			0.9-1.9'	Base	A-1-b(0)	NP	NP	42	27	15.3							72
11	2			1.9-6.5'	Subgrade	A-1-a(0)	NP	NP	27	16	9.2			Too Rocky	2.1			
12		9/26/12	10.0' RT SB	0.0-0.5'	MM 223.50	Oil Mat												43
12	1			0.5-1.9'	Base	A-2-4(0)	23	8	30	16	10.7							72
12	2			1.9-6.5'	Subgrade	A-1-a(0)	18	3	29	15	8.4			Too Rocky	1.7			
13		9/26/12	10.0' RT SB	0.0-0.75'	MM 223.0	Oil Mat												40
13	1			0.75-1.7'	Base	A-1-a(0)	NP	NP	42	15	10.1							57
13	2			1.7-6.0'	Subgrade	A-2-4(0)	24	9	30	17	11.1			Too Rocky	3.0			

Remarks:
Holes #10, #11, #12, and #13 stopped on hard surface

Distribution: Preconstruction Bureau; Geotech, Materials Bureau; Surfacing Design, Materials Bureau; District Lab; Area Lab, C. McOmber, GF Design
NDT Data Collection

This page intentionally left blank.

The base course appears to be in very good condition since it classified as A-1-a(0), is non-plastic, has about 8-9% fines, and has very high R-Values mostly in the upper 70s.

Based on this information, the designer decides that PMS stripping is the root cause of the pavement distress, and it should be removed and replaced.

The preliminary rehabilitation recommendation is to remove all PMS. This will be done by milling and removing the majority of the PMS, and pulverizing the remaining PMS into the existing base course. To reduce the project cost, the designer and the District have decided that the shoulders should be left in place as much as possible.

Step 2: Determine the existing pavement structure's structural capacity (SN_{eff})

Estimating existing structural capacity is done by estimating the average depth and condition of the PMS and base course, and calculating SN_{eff} with the following equation:

$$\begin{aligned} SN_{eff} &= SN_{PMS} + SN_{Base} + SN_{sub} \\ &= d_{PMS}a_{PMS} + d_{Base}a_{base} + d_{sub}a_{sub} \\ &= \sum_1^n d_{PMSn}a_{PMSn} + d_{Base}a_{base} + d_{sub}a_{sub} \end{aligned}$$

Where:

SN_{eff} = existing pavement structural number

$d_{PMS}, d_{Base}, d_{sub}$ = Average thicknesses of the existing PMS, Base Course, and Subbase Course (ft. or in.)

$a_{PMS}, a_{base}, a_{sub}$ = The average effective structural coefficient of the existing PMS, Base Course, and Subbase Course layers

n = Number of individual PMS lifts within the existing pavement. Often, each lift (layer) of PMS has different levels of degradation, so the SN of each lift is calculated separately.

It is decided to determine the PMS depth based on the core information due to the abundance of cores. Based upon the core summary, the average PMS depth is about 0.75 ft.

The core information is also used to determine the PMS condition as characterized to the structural coefficient. All lifts of the PMS are stripped and in about the same condition, so the entire PMS layer will be characterized with one structural coefficient rather than specifying a different structural coefficient for each lift. The average stripping score is about 1.5, which corresponds to a structural number 0.20/in. or 2.4/ft., as shown in Exhibit D-8 (see Chapter 14, Exhibit 14-6).

**Exhibit D-8
Average Stripping
Score and Structural
Coefficient**

Average Stripping Score	Structural Coefficient in. (ft.)
3.0 – 4.0	0.33 (4.0)
1.5 – 3.0	0.27 (3.2)
0 – 1.5	0.20 (2.4)

The structural number of the PMS layer is $0.75' * 2.4/\text{ft.} = 1.8$.

The base course depth and coefficient are found from the base course soils survey. The average base course depth from the soil survey is 1.77 ft. The base course condition is also taken from the soil survey. The gravel classifies as A-1-a(0), the fines average about 9% passing the No. 200 sieve and are non-plastic, and the R-Value average in the upper 70s, all indicating that the base course is in very good condition. The base course M_R is determined using the following equation:

$$M_{R(\text{Base})} = 2555 * (75 / (1 + 0.00728 * \text{PI} * \text{P200}))^{0.64}$$

Where:

Maximum $M_{R(\text{Base})} = 29,000$ psi

$M_{R(\text{Base})}$ = Resilient Modulus of the unbound base or subbase course (psi)

PI = Plasticity Index (%)

P200 = Percent Passing the No. 200 Sieve (%)

Inserting 8% passing the No. 200 and PI = 0, the estimate base course M_R is 40,500 psi. Based on exhibits in Chapter 14 (also shown below), 40,000 psi corresponds to structural coefficient = 0.18/in. However, it is MDT policy to use maximum 0.12/in. for existing base course. Exhibit D-9 provides an example.

**Exhibit D-9
Conversion Graph for
FWD M_R to CAC
Structural Coefficient**

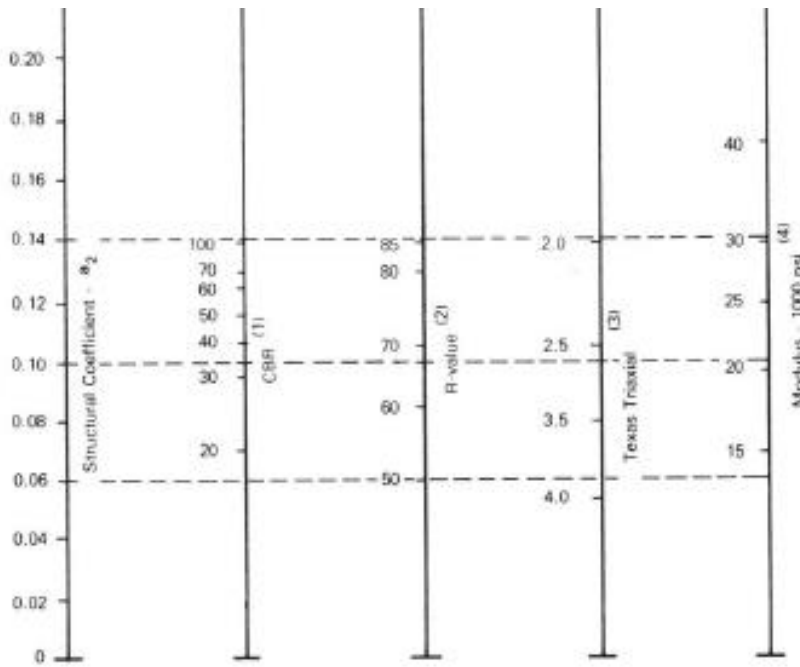

(Chapter 14, Error! Reference source not found.14-6)

The base course SN = $1.77' * 0.12/\text{in} * 12 \text{ in}/\text{ft} = 2.55$

The existing pavement structure is:

$$\begin{aligned}
 SN_{\text{eff}} &= SN_{\text{PMS}} + SN_{\text{Base}} + SN_{\text{sub}} \\
 &= 1.8 + 2.55 \\
 &= 3.35
 \end{aligned}$$

Step 3: Determine the structural capacity needed for the new pavement (SN_{dgn})

DARWin 3.1 will be used to find SN_{dgn} . This design is done in accordance with Chapter 1 and Chapter 5.

DARWin is opened by double clicking on the desktop icon labeled “DARWin 3.1.” Generally, an error message will occur, and the “OK” button must be clicked several times before the program opens. The opening screen is seen below in Exhibit D-10.

**Exhibit D-10
DARWin Project Screen**

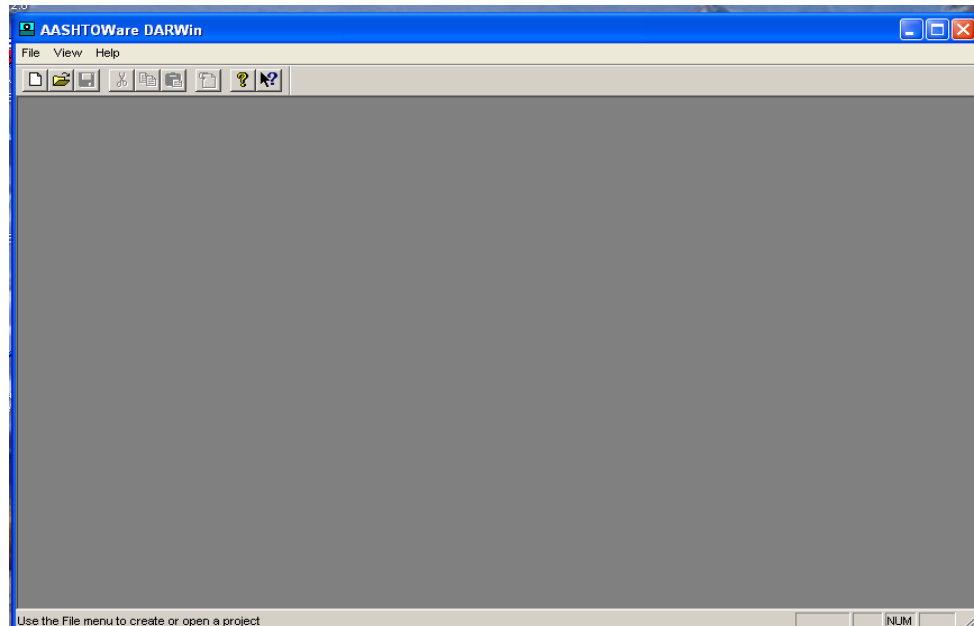

To create a new project, click on "File" at the upper left and select "New." The following screen will appear, as shown in Exhibit D-11. Type in the UPN/Control Number for the project in the space under "Project Name," and click "OK." Exhibit D-12 shows the new project screen template.

**Exhibit D-11
New Project Screen**

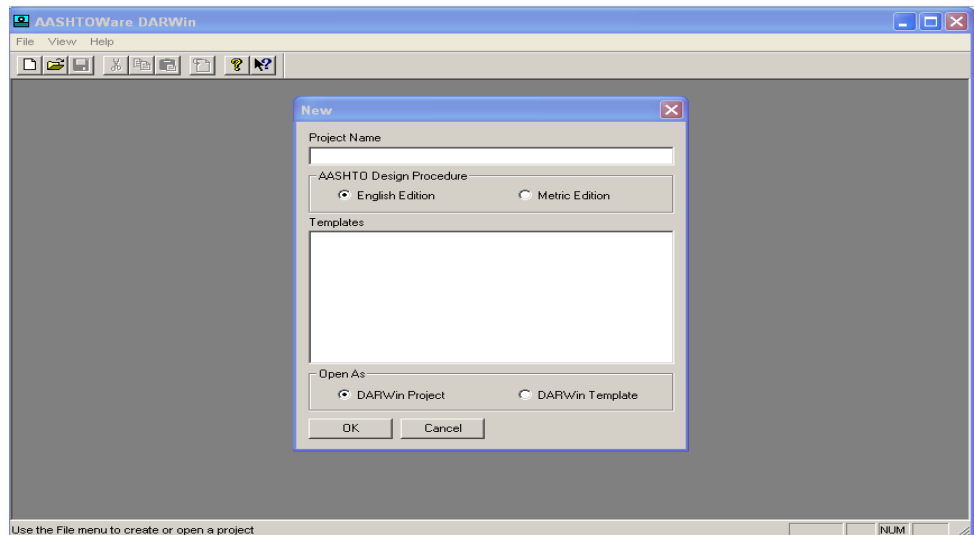

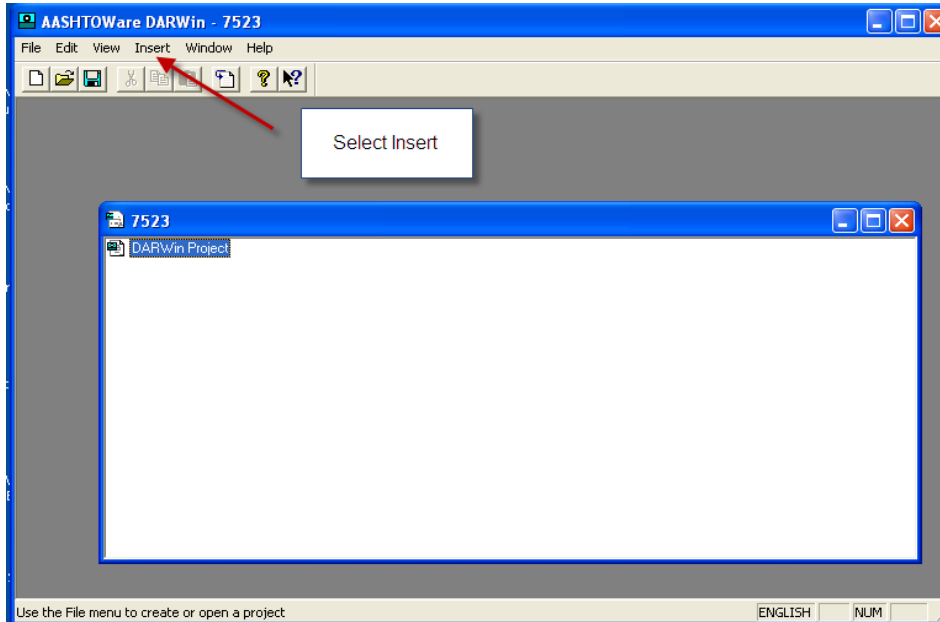

**Exhibit D-12
New Project Screen
Template**

Click on DARWin Project in the template, and then click on “Insert” in the header and select “New Module,” as shown in D-13.

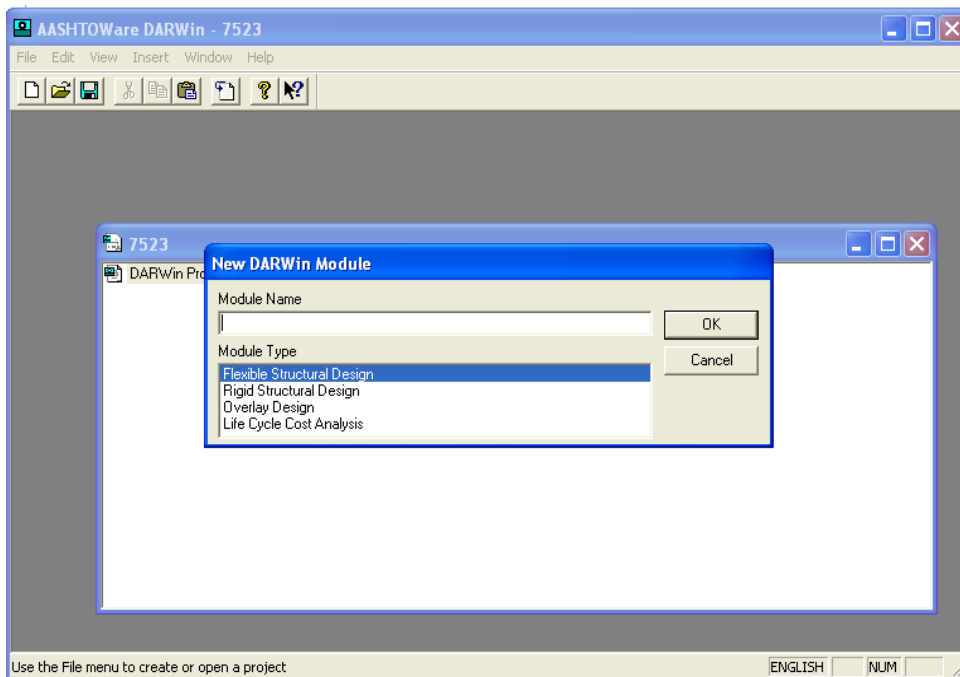

**Exhibit D-13
New DARWin Module
Template**

Enter the CN number as the module name and click OK: the module has automatically selected Flexible Structural Design. Under the Description, enter the project name and number, as well as any other relevant information. Exhibit D-14 shows the DARWin flexible design template.

Exhibit D-14
DARWin Project Screen

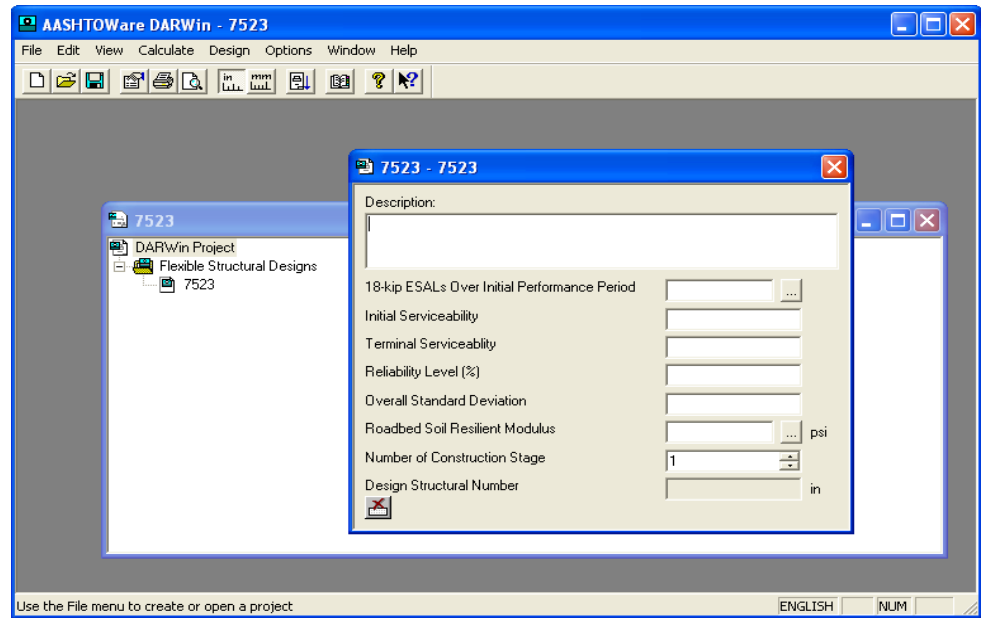

Enter the Pavement Design Inputs:

- **Traffic:** The traffic memorandum reports 1,104 daily ESALs. Lifetime ESALs are calculated by multiplying the daily ESALs by 365 days and 20 years design life.
 $1,104 \times 365 \times 20 = 8,059,200$ lifetime ESALs
- **Serviceability:** Enter 4.5 for Initial Serviceability, and 2.5 for Terminal Serviceability
- **Reliability:** Enter 95% as the Reliability Level
- **Overall Standard Deviation:** Use 0.45 as Overall Standard Deviation
- **Subgrade Modulus:** The average FWD Subgrade lab M_R is 13,383 psi. MDT typically uses 12,000 psi for subgrade soils with an R-Value of 30 (2 feet of special borrow). The designer in this example chose to use 12,000 psi for the design. No subgrade sampling was done on this project.

Now click the small button on the lower left with the red "X." A Design Structural Number of 4.10 will appear in the box below. Therefore, $SN_{dgn} = 4.10$. Exhibit D-15 shows a completed design template with DARWin-calculated design structural number.

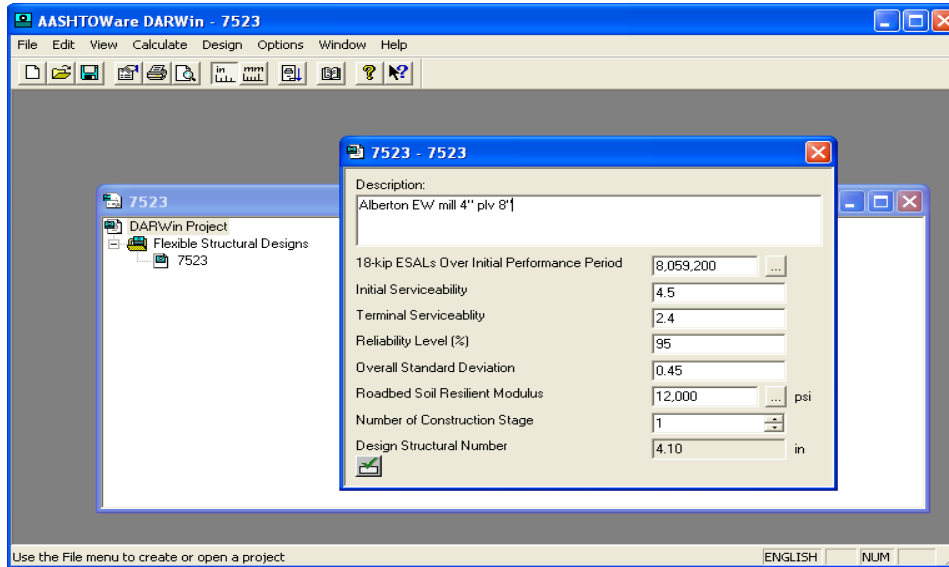

Exhibit D-15
Completed Design
Template

Step 4: Complete Pavement Rehabilitation Design

SN_{ol} is the amount of pavement structure that needs to be added to the existing pavement to meet the current demand. SN_{ol} is calculated as follows:

$$\begin{aligned} SN_{ol} &= SN_{dgn} - SN_{eff} \\ &= 4.10 - 3.35 \\ &= 0.75 \end{aligned}$$

SN_{ol} is greater than 0, indicating that the existing pavement is structurally inadequate to perform well over the 20-year design period. Recall from Step #1 that the pavement grade cannot be raised, so the existing pavement will need to be strengthened to make up for the structural deficiency. Also, recall from Step #1 that the existing PMS is stripped and needs to be removed or rehabilitated.

The rehabilitation design will be done using the DARWin 3.1 software. Click on "Design" on the header, and then select Thickness Design. The template will look like Exhibit D-16.

**Exhibit D-16
DARWin Thickness
Design Template**

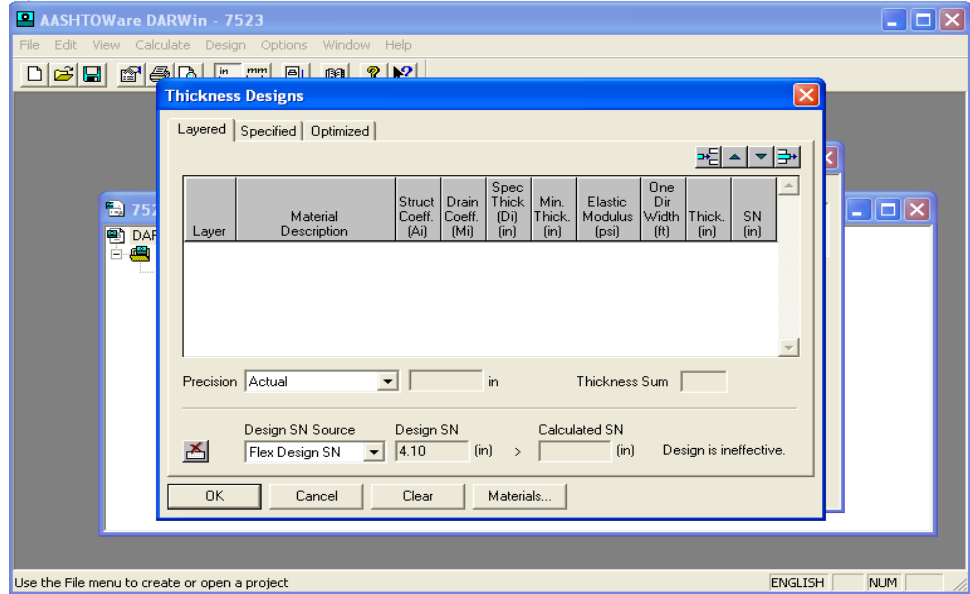

Click the Specified tab at the top, and click the insert layer three times to provide for the PMS, pulverized layer, and existing base layer as shown in Exhibit D-17.

Enter the material descriptions (i.e. PMS, CAC, existing CAC), structural coefficients, drainage coefficients, and thicknesses. Structural coefficients for the new PMS and pulverized material are shown in Exhibit D-18, and structural coefficient for existing material was determined in Step #3. Drainage coefficients are routinely assigned 1.0 by MDT. Minimum PMS design thicknesses are shown in Exhibit D-19.

**Exhibit D-17
DARWin Thickness
Design Template with
Specified Tab Selected**

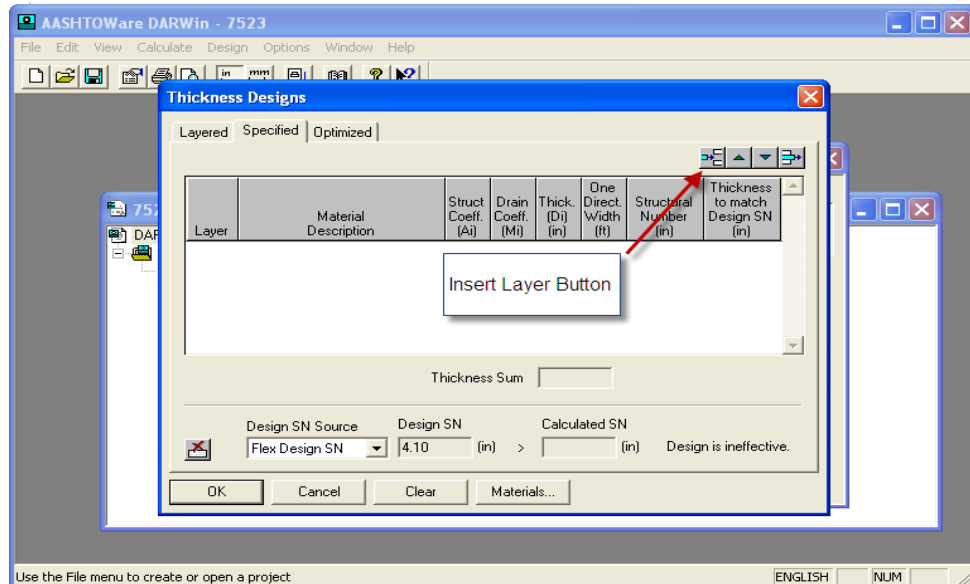

MDT Structural Coefficients for Different Pavement Layers	
Layer	a_i
Plant Mix (PMBS)	0.41
CAC gravel	0.14
RAP/ Aggregate	0.12
CTB	0.20

Exhibit D-18
MDT Structural
Coefficients

ESALs (Daily)	PMS Thickness ¹
> 2000	0.70'
1000 - 2000	0.60' – 0.70'
501 - 1000	0.50' – 0.60'
201 - 500	0.40' – 0.50'
101 - 200	0.30' – 0.40'
0 - 100	0.30'*
Other Situations	PMS Thickness
Urban Curb and Gutter	0.40' min
Mainline Interstate Pavements	0.50' min
Rest Areas	0.40' min

Exhibit D-19
PMS Thickness for
Daily ESALs

¹In certain cases 0.25' of PMS can be used for ½" or 3/8" mix, when budgets are constrained.

In Step #1, it was hypothesized that milling and removing the stripped plant mix followed by pulverization would fully remove or treat the PMS stripping problem. Exhibit D-19 indicates at least 0.60 ft. (7.2 in.) of plant mix is required for this road's traffic level. The routine 0.65 ft. (8 in.) pulverization depth will be used to mix the remaining PMS and the uppermost CAC together, leaving approximately 0.80 ft. (10 in.) existing base. Also, recall from Step #1 that the existing shoulders should be utilized as much as possible to reduce project cost. Enter these thicknesses into DARWin as shown in the following Exhibits D-20 and D-21. This yields an SN of 5.11 which is significantly stronger than the design SN of 4.10.

**Exhibit D-20
Partially Completed
Thickness Design
Template**

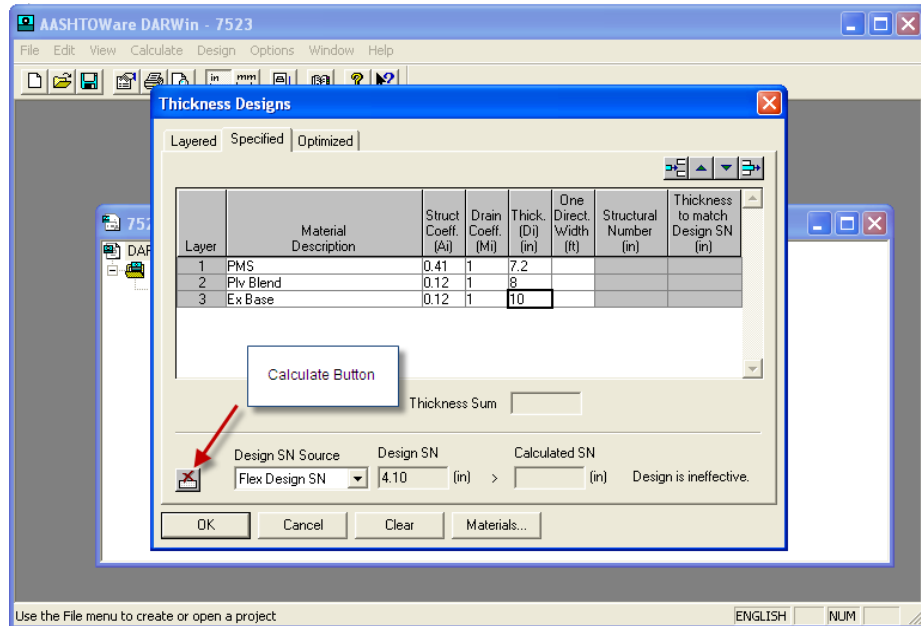

**Exhibit D-21
Completed DARWin
Thickness Design**

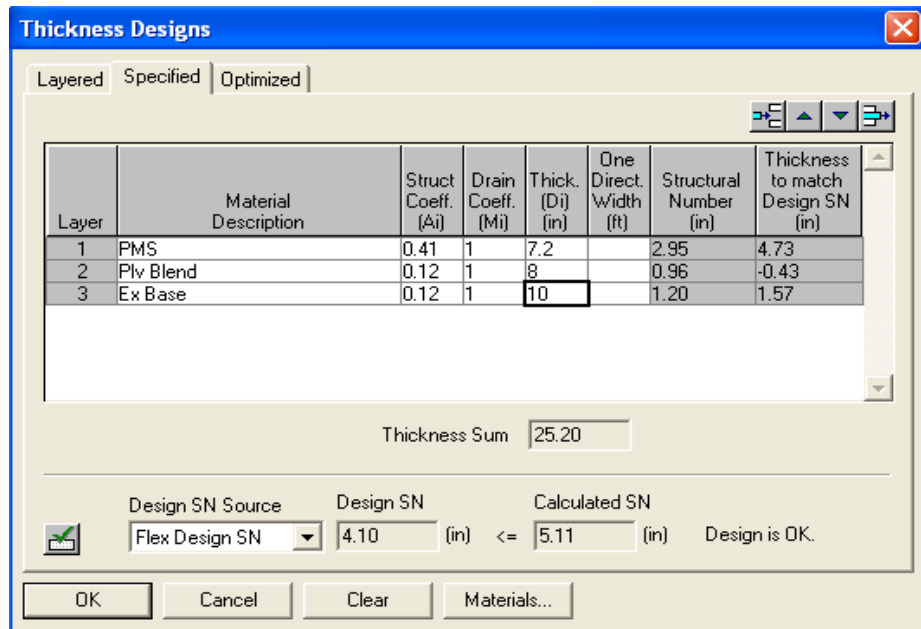

Regarding the shoulder design, the shoulders will be milled and filled 0.30 ft. The reasons for this are that within the travel lanes, the top 0.30 ft. will be virgin PMS, while the bottom 0.30 ft. will be PMS with recycled asphalt pavement (RAP). Milling and filling the entire road width with 0.30 ft. virgin PMS will provide constructability advantages, and will be explained further in Step #5.

Now that the pavement design is complete, click “OK,” click on “File” in the upper left-hand corner of the main pane, and click save. A “Save As” pane will come up as shown in the following Exhibit D-22, Dialogue for Saving Your Work.

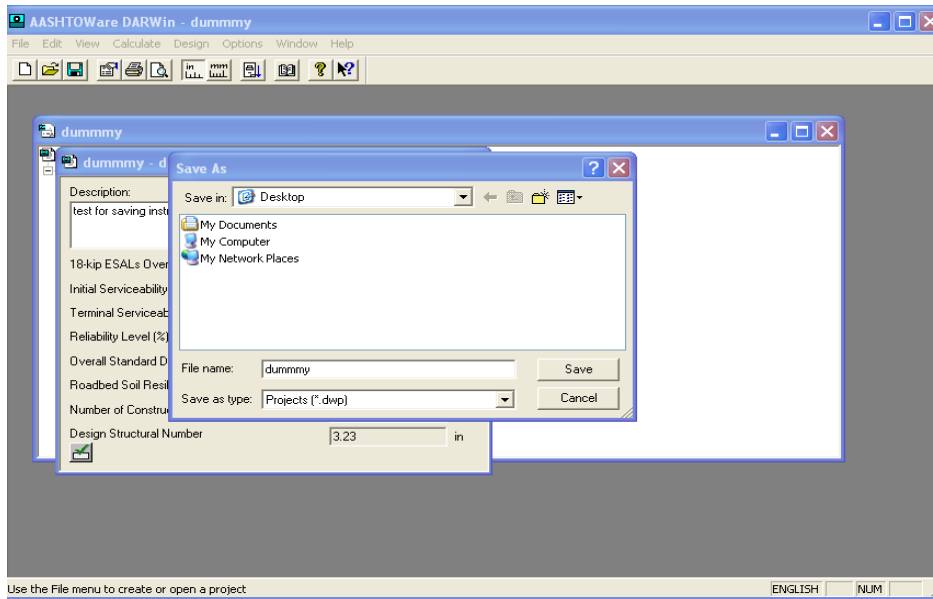

Exhibit D-22
Dialogue for Saving
Your Work

Click on “My Computer,” and the selection will change as shown in Exhibit D-23 below. Click on the “rdtr on ‘MDT Astro (astro)’” drive and click on the “DARWIN” folder, which is the standard location to place DARWin design files. The standard file name for DARWin design files is the 7-digit Construction Number (CN), and DARWin design files are designated by the file extension .dwp. For the Alberton E – W project, the file name will be 7523000.dwp. Click the save button.

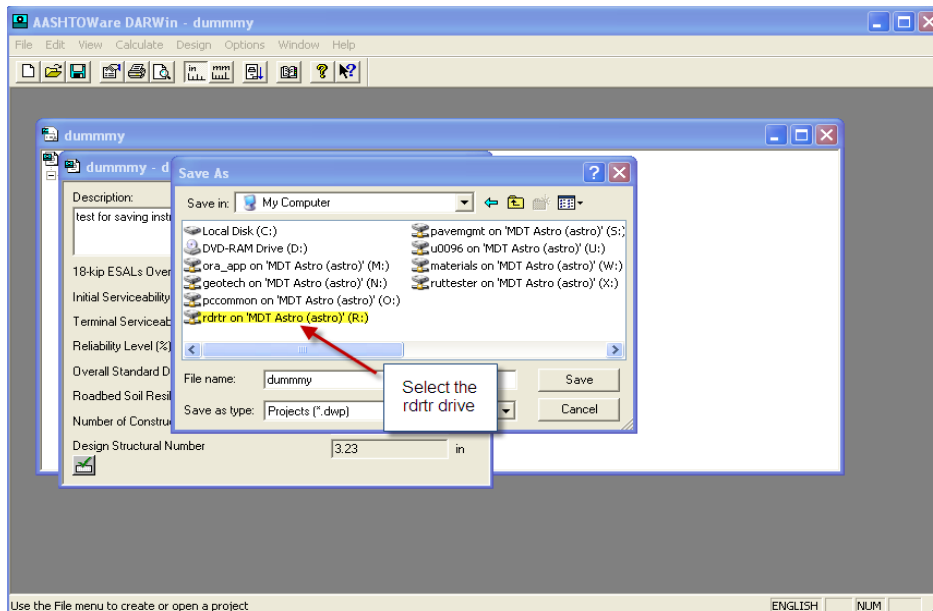

Exhibit D-23
Highlighted Location of
the rdtr Drive

Step 5: Specify Pavement Materials and Construction Methods

After the thickness design is completed, the next step is to specify the pavement materials to be within the pavement.

The PMS type needs to be chosen first since that will determine the need for a surface treatment. PMS type is chosen based upon PMS quantity and project type as shown in Chapter 3, Section 3.4.1.

PMS Type Selection

First, the PMS tonnage is calculated. Recall that this design example is a small portion of a 9.0 mile project. Also, based on discussion with the Road Design project manager, the finished roadway width will be 28 ft. Use the equation below to calculate PMS tonnage:

$$\begin{aligned} & \text{Project Length (miles) / project} \times 5280 \text{ ft. / mile} \times \text{Roadtop Width (ft.)} \\ & \times \text{PMS thickness (ft.)} \times 1 \text{ yd}^3/27 \text{ ft}^3 \times 3855 \text{ lbs. / yd}^3 \times 1 \text{ ton PMS / 2000 lbs.} \\ & \qquad \qquad \qquad = \text{tons PMS / project} \end{aligned}$$

OR:

$$\begin{aligned} & 9.6 \text{ miles / project} \times 5280 \text{ ft. / mile} \times (40' \text{ pavement width}) \times (2 \text{ sides of} \\ & \text{Interstate} \times 0.60' \times 1 \text{ yd}^3/27 \text{ ft}^3 \times 3855 \text{ lbs. / yd}^3 \times 1 \text{ ton PMS / 2000 lbs.} \\ & \qquad \qquad \qquad = \mathbf{173,690 \text{ tons PMS / project}} \end{aligned}$$

Based on 173,690 tons PMS, Exhibit 3-5 specifies that either ½ in., ¾ in., or 3/8" Grade S Volumetric should be specified.

To further refine the PMS type, use Exhibit 3-7 for this reconstruction project with 0.30 ft. PMS. The table specifies that ¾ in. Grade S or Commercial Plant should be used. Since both tables allow ¾ in. Grade S Volumetric, the designer should recommend using **¾ in. Grade S Volumetric** on the project.

Recall from Step #1 that the District would like to use RAP as much as possible. **Error! Reference source not found.**3 indicates that RAP contents up to 15% and 30% in the top and bottom lifts are allowed. On this project it was decided to use Virgin PMS on the top 0.3 ft. PMS (as shown above), and PMS containing 30% RAP on the bottom lifts. The PMS for the bottom lifts will be "Plant Mix Bit Surf Gr S – ¾ in. RAP" and 30% RAP content within the project Special Provisions.

PG Binder Selection

The criteria for picking PG Binder type is in Chapter 3 Section 3.1.3. This project has more than 400 daily ESALs and is also an Interstate Roadway. For the top 0.30 ft. of virgin PMS, PG 70-28 is selected, which is a polymer modified binder.

The bottom 0.30 ft. will consist of PMS with RAP. Here is the guidance given in Chapter 3 regarding specifying PG binders in PMS with RAP:

Consideration should be given to using a lesser PG binder grade in lower lifts when 0.4' or more new PMS is required. As a general rule of thumb, binder grade can be dropped one grade within PMS located more than 0.2' below the pavement surface.

For PMS with more than 20% RAP, reduce the PG binder grade by one binder grade to account for the oxidized binder within the RAP.

Since the PMS with RAP is more than 0.2 ft. below the pavement surface and contains more than 20% RAP, the Binder type can be bumped down twice from what is shown in (PG 70-28). That suggests that PG 58-28 should be specified. However, this project is the first project where Grade S PMS with RAP will be used, so the pavement design engineer recommends that **PG 64-28 be used within the PMS with RAP** since it has polymers and will lower the potential risk.

Asphalt Content Selection

The selection of asphalt content is described in the section **Error! Reference source not found.** 3, Section 3.1.4. Based on the Asphalt Map, 5.2% **asphalt content** is estimated.

Within the **PMS with RAP layer, use 4.2% asphalt content.** This is determined by interpolating between the asphalt contents for 25% and 40% RAP within **Error! Reference source not found.**3, Exhibit 3-11 **Error! Reference source not found.**

Surface Treatment Selection

This project has Average Annual Daily Traffic (AADT) of 7,090 and has a 70 mph posted speed. Based upon Exhibit 11-2, a Type I chip seal should be specified since this is a newly constructed road with no rutting, high traffic speed, and low traffic volume. However, chip seals tend to wear off within the wheel paths within this geographic area. Due to this, a **Type II chip seal** will be specified since it will provide better durability.

Step 6: Sending the Pavement Design Memorandum

Now that the thickness design and pavement materials have been determined, the last task is to send a paper copy of the Surfacing Design Memorandum to road design staff via interdepartmental mail. The following page shows the Surfacing Design Memorandum for this project. Note that the memorandum is not signed. In practice, both the pavement design engineer and designer sign the memorandum to the right of their printed names.

Verify that the correct distribution has been used. After completing the Surfacing Design Memorandum in Microsoft Word, save the .docx file to the Surfacing Design Unit shared drive. Also, save the file as *.*.pdf file to be uploaded to the document management system. Appendix C outlines the steps to name the file and upload the document. Projects designed by a consultant will be handled within the corresponding activity in the appropriate flowchart.

Once the memorandum has been submitted for distribution and saved, the EPS activity may be carded.

Montana Department of Transportation
Helena, MT 59620-1001

Memorandum

To: Paul Ferry, P.E.
Highways Engineer

Thru: Dan Hill, P.E.
Pavement Engineer

From: Ed Shea
Surfacing Design

Date: July 31, 2012

Subject: IM 90-1(196)74
Alberton – E & W
Control Number 7523000

Hereby transmitted is the *preliminary* surfacing section for the surfacing structure on the subject project. This recommendation completes the Surfacing Design 600 activity.

Surfacing Section No. 1 – Travel Lanes – BOP to EOP
0.30' Plant Mix Bituminous Surfacing Grade S
0.30' Plant Mix Bituminous Surfacing Grade S with 30% RAP
0.60'
Design R-Value = 20

Mill and Remove 0.60' existing PMS from within travel lanes and extending 1' beyond outside shoulder stripe. After milling, pulverize milled surface 0.6' deep and recompact. Place 0.60 PMS as shown above.

Surfacing Section No. 2 - Shoulders – BOP to EOP
0.30' Plant Mix Bituminous Surfacing Grade S

Mill 0.30' prior to placing 0.30' PMS.

Place Type II chip seal upon finished PMS over entire road width.

The designs are based on 1104 daily ESALs from traffic dated Feb. 2012. The design life of the recommendations is 20 years considering AASHTO design procedures.

Within the top 0.30' PMS, utilize ¾" Grade S with 5.2% asphalt content utilizing PG 70-28 binder. Within the lower 0.30' PMS, utilize Grade S PMS with 30% RAP with 4.2% asphalt content utilizing PG 64-28 binder.

Prior to construction, the District should review the soil survey for R-values. Areas of concern and possible borrow areas should have additional soil samples submitted for R-value testing.

If you have any questions concerning this recommendation, please contact me.

cc: E. Toavs, P.E.
D. Krings, P.E.

S. Stack, P.E.
Surfacing File

Materials Bureau File
Geotechnical File



Appendix E

1993 AASHTO DARWin 3.1

(Design, Analysis, and Rehabilitation for Windows) - Pavement Reconstruction Design Example

This design example summarizes the design of a reconstruction pavement section for the Jct US 2 – North of Chester project. This is a low-volume roadway (less than 137 ESALS per AASHTO), and the example includes both low-volume and conventional design methods. The following information presents a summary of items that may affect the pavement design:

Project Name:	Jct US 2 – North of Chester
Project Number:	STPS 409-1(7)0
Construction Number (CN):	6164
Existing Surface:	Thin gravel on native soil
Project Limits:	RP 0.0 to 0.6
Project Type:	Reconstruction with flexible pavement
District:	Great Falls
Geography:	Flat terrain, plains
Climate:	Low Precipitation, Frozen during winter
Traffic:	Daily ESALs = 54 Daily AADT (Average Annual Daily Traffic) = 360
Soils:	Poor to very poor stiffness, cohesive, and fine grained

Information available to designer:

- Soil Survey from District Materials Lab
- Falling Weight Deflectometer Subgrade Resilient Modulus

Step 1: Determine Flexible Pavement Design Inputs

Traffic: The daily was provided by MDT’s Traffic Data Unit, the daily ESALs are 54, and the daily AADT is 360 vehicles. Calculate the ESALs during the 20-year design life:

$$(54 \text{ ESALs/day})(365 \text{ days/year})(20 \text{ year/design life}) = 394,200 \text{ daily ESALs/Design Life}$$

Initial and Terminal Serviceability: 4.2, 2.5, and

Reliability Level and Standard Deviation: 75% and 0.45

Drainage Coefficient: 1

Number of Construction Stages: 1

Subgrade Resilient Modulus: This pavement design is for the first 0.6 miles of a larger 9.4 mile project. Exhibit E-1 shows the District Soil Survey, where the orange outlining designates the subgrade soils that will likely be encountered.

The 85th percentile R-Value (R85%) is used for design (Chapter 5). In this case there are 5 subgrade R-Value samples, 4 of which are A-6. Recall that A-6 and A-7 soils are automatically given an R-Value = 5. Using the process outlined in Chapter 5, Section 5.5.7, it is determined that R85% = 5.

R85% is converted to MR(Des) as follows (**Error! Reference source not found.**):

$$\begin{aligned} M_{R(Des)} &= 1155 + 555 * R_{85th\%} \\ &= 1155 + 555 * (5) \\ &= 3,930 \text{ psi} \end{aligned}$$

MR(Des) =3,930 psi will be rounded down to MR(Des) =3,750 psi based on engineering judgment.

**Exhibit E-1
Sample Soil Survey
Form**

Montana Department of Transportation
Preconstruction Soil Survey Data
and Special Recommendations Relative to Subgrade and Road Surface Design

Project Number STPS 409-1(7)0 PE Project Name Jet US 2-N of Chester Length 9.4 miles County Liberty Date 01/14/13
UPN 6164 Contract No. Stanley Kuntz
Submitted by N. Procto Title Area Lab Supervisor District Materials Supervisor Dist. Preconstruction Engineer

Hole Number	Sample Number	Date	Reference to Centerline - Location of Boring	Depth	Representing Stationing	Soil Class (MT214)	LL	PI	10 Mesh (2.00 mm)	40 Mesh (.425 mm)	200 Mesh (.075 mm)	In Place Density	Specific Gravity	Density Maximum Dry	Moisture Percent Natural	Moisture Percent Optimum	Water Table Depth to	(AASHTO T190) "R" Value
9	2	10/26/12	4.0 R RT	2.0-5.4 ft	211+17	A-6(9)	31	11	99	99	90.5	2.679	110.1	9.2	15.7			
10	1	10/26/12	7.0 R LT	0-5.6 ft	237+38	A-6(10)	20	6	99	96	38.8	2.672	118.8	7.6	12.6			38
11	1	10/26/12	13.0 R LT	0-4.0 ft	264+00	A-6(12)	35	19	96	93	73.7		112.4	12.5	14.7			
11	2	10/26/12	13.0 R LT	4.0-5.8 ft	264+00	A-6(13)	37	20	97	95	73.0		109.5	12.2	16.2			
12	1	10/26/12	1.0 R LT	0-2.4 ft	292+15	A-6(1)	32	15	59	52	37.2		135.3	6.5	10.6			
12	2	10/26/12	1.0 R LT	2.4-5.1 ft	292+15	A-6(14)	40	24	92	87	69.4		110.5	12.7	16.8			
13	1	10/29/12	12.0 R RT	0-5.3 ft	316+77	A-6(13)	36	20	93	89	70.1		112.1	14.7	15.3			

The other source for estimating Subgrade M_R is utilizing FWD information. This particular project is presently a gravel road, so FWD information is not available.

Step 2: Determine required Structural Number (SN_{des}) for low volume

1993 AASHTO Low-Volume Road Design

This road is considered low volume because it has fewer than 137 daily ESALs. This being the case, SN_{des} should be determined using both the AASHTO Low-Volume Method below and the conventional flexible pavement design method. This only applies to roads with a reliability of 75% unless case specific conditions dictate a lower value for NHS or primary routes. After calculating SN using both methods, the smaller of the two is chosen for pavement design.

The daily ESALs fall in the low range of the Medium category, and the designer made the decision to categorize the subgrade as very poor soils. Montana is entirely within Region VI: Dry, Hard Freeze, and Spring Thaw. Using these inputs in 1993 Guide (Part II, Chapter 4, Low Volume Road Design)**Error! Reference source not found.**, an adequate low-volume structural number (SN) is 3.4.

Step 3: Determine the required Structural Number using the DARWin software

1993 AASHTO Conventional Flexible Pavement Design

It should be noted that DARWin runs on Windows XP as of 2014, MDT has converted to Windows 7. Because of this, the in-house designer will have to use a remote desktop connection to open DARWin on another computer. DARWin is opened by double clicking on the desktop icon labeled "DARWin 3.1." Generally, an error message will occur, and the "Ok" button must be clicked several times before the program opens. The opening screen is shown in Exhibit E-2.

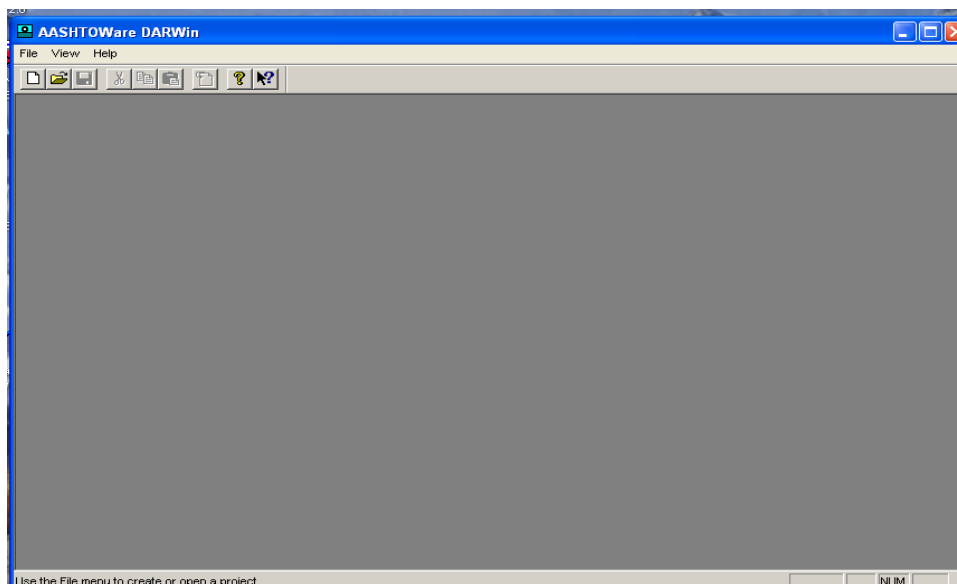

**Exhibit E-2
DARWin Opening Screen**

Click "File" at the upper left, and select "New" to create a new project. The following screen (Exhibit E-3) will appear. Type the UPN/Control Number for the project in the space under "Project Name," and click OK. This will bring up the template in Exhibit E-4.

**Exhibit E-3
DARWin New project
screen**

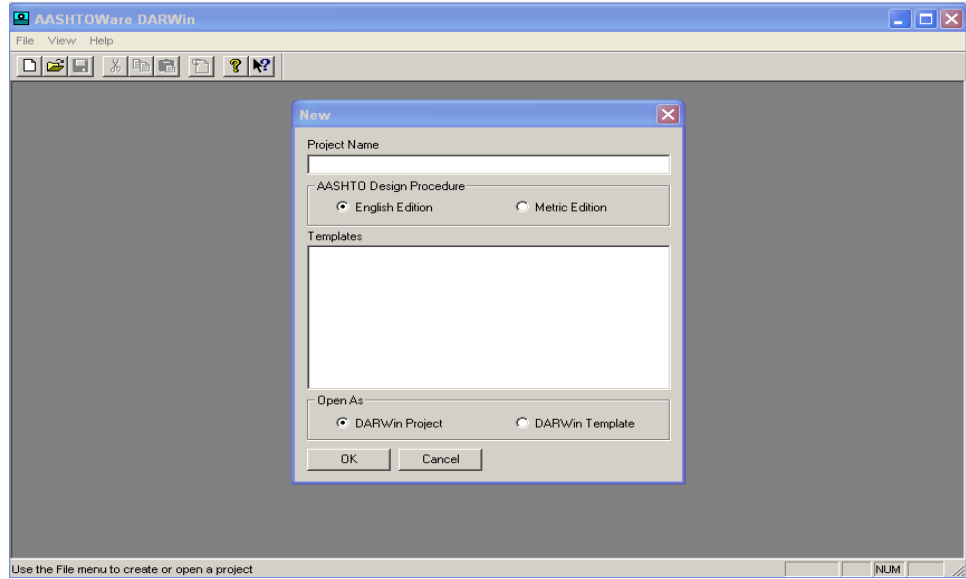

**Exhibit E-4
DARWin New project
screen template**

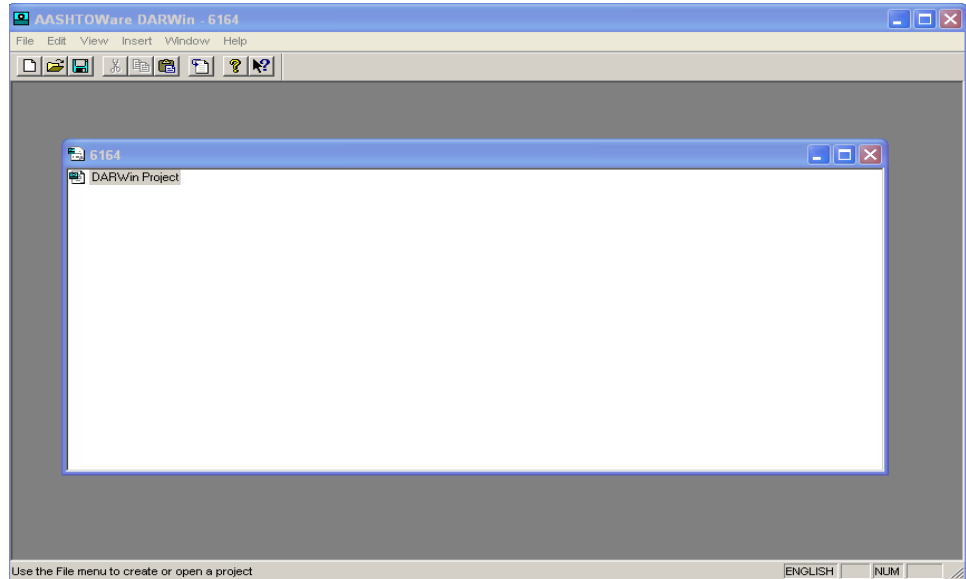

Click on DARWin Project in the template, click on “Insert” in the header and select “New Module.” The screen will look like Exhibit E-5.

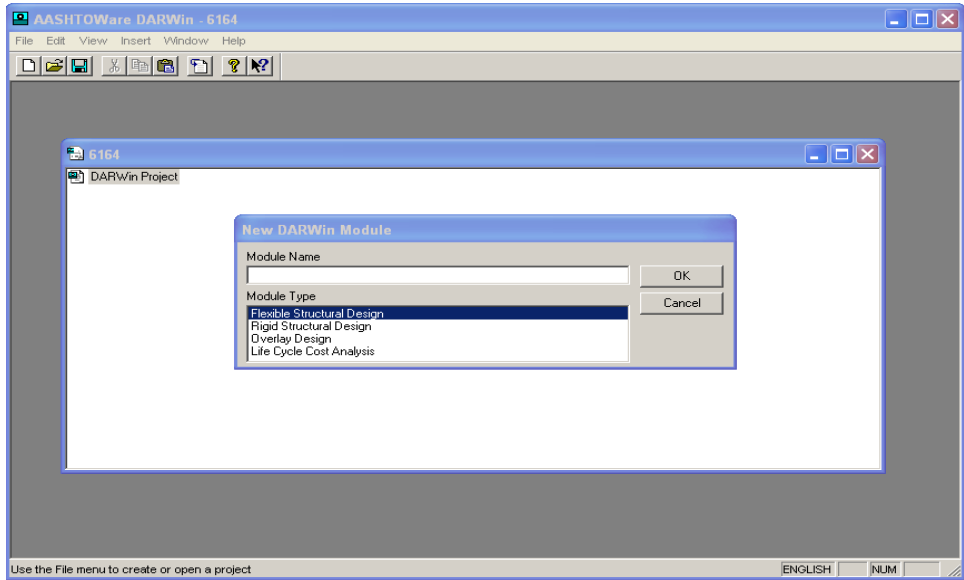

**Exhibit E-5
DARWin New Module template**

Enter the CN number as the Module Name and click OK: the module has automatically selected Flexible Structural Design. The screen will look like Exhibit E-6.

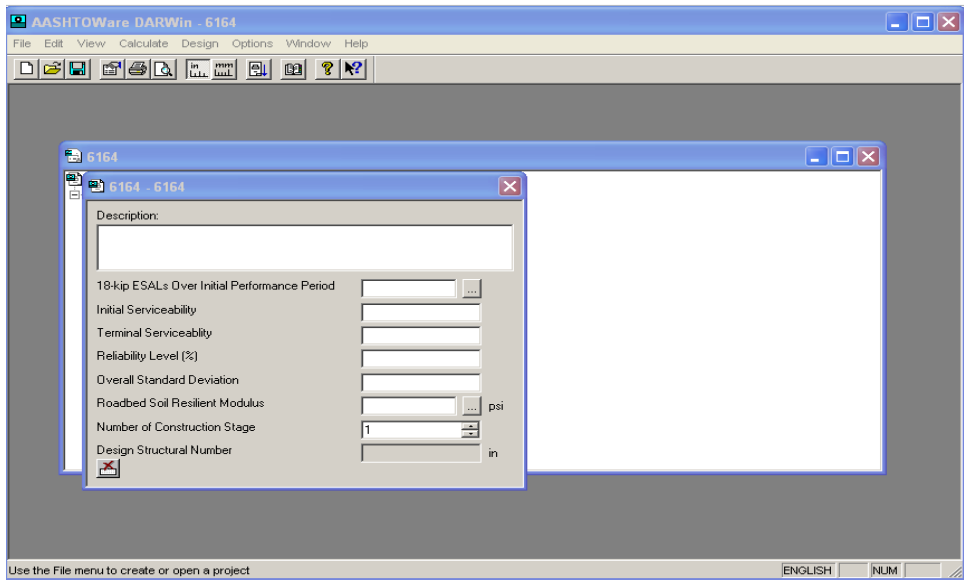

**Exhibit E-6
DARWin flexible structural design template**

Type the project name and number under “Description.” Next, enter design inputs from Step #1, and click the red “X” button. A DARWin Design Structural Number of 3.46 will appear in the box as shown in Exhibit E-7.

**Exhibit E-7
DARWin Completed
design template**

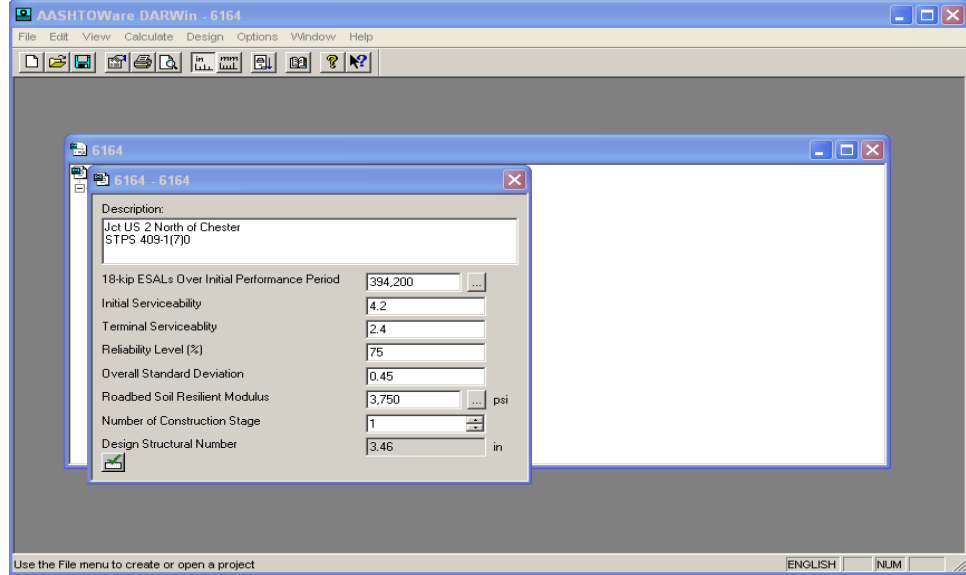

Recall that SN_{des} is the lesser SN from the low-volume and conventional AASHTO designs. In this case, the low volume SN = 3.4 will be used for the pavement design.

Step 4: Design a flexible pavement structure with $SN_{Req,d} \geq SN_{Des}$

Click "Design" on the header and select "Thickness Design." The template will look like Exhibit E-8. Select the Specified tab at the top, and click the insert layer button indicated in Exhibit E-9 twice to provide PMS and CAC layers.

**Exhibit E-8
DARWin thickness
design template**

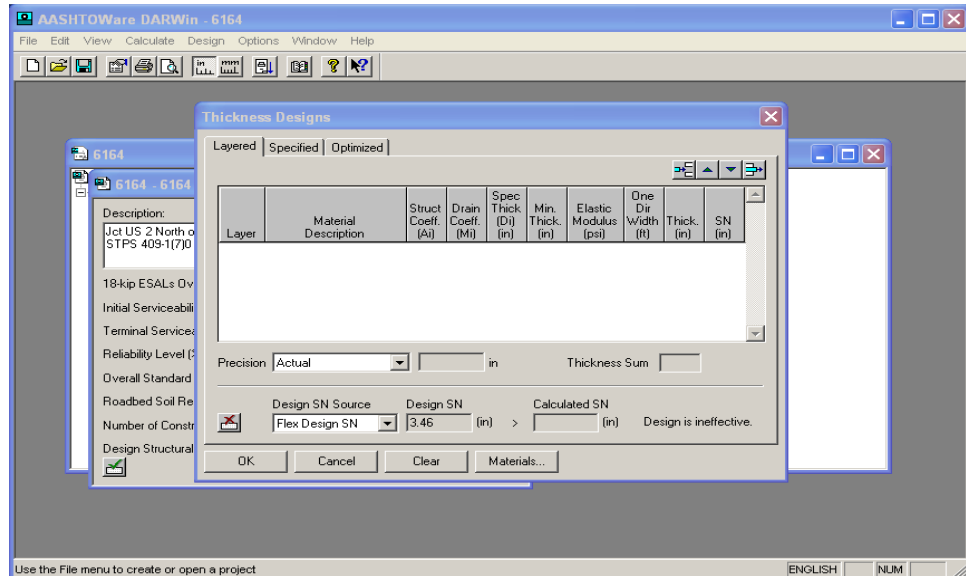

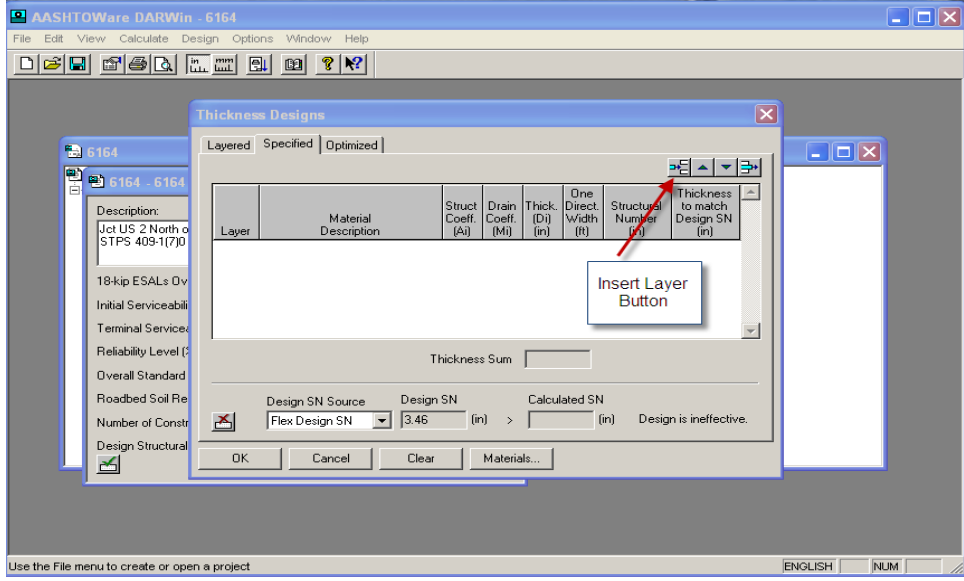

Exhibit E-9
DARWin thickness design
template with "Specified" tab
selected.

Enter the material descriptions, structural coefficients, drainage coefficients, thicknesses, and one directional width as shown in Exhibit E-10.

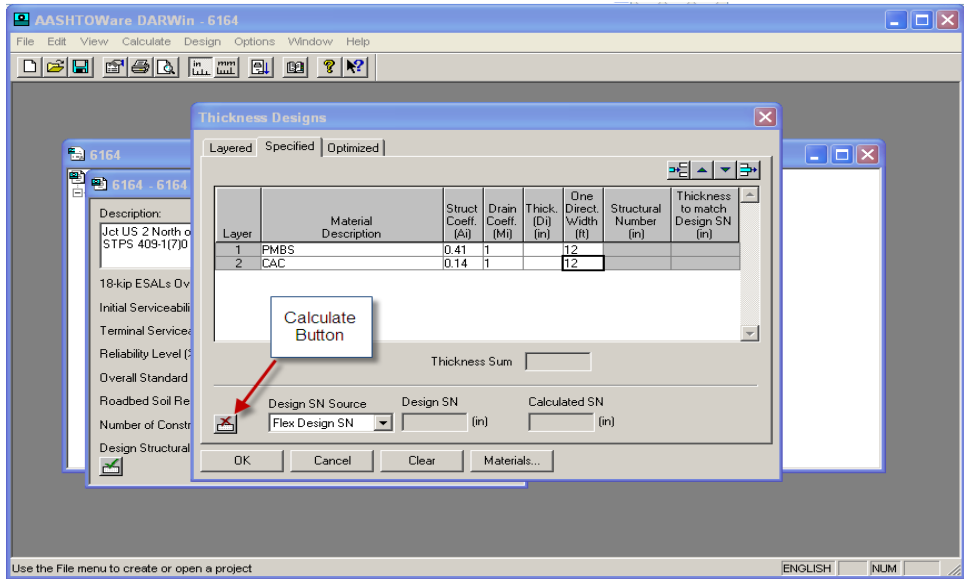

Exhibit E-10
DARWin Partially Completed
Thickness Design template

Structural coefficients for different pavement layers are shown in Exhibit E-11. **Error! Reference source not found.**

Exhibit E-11
Structural Coefficients for
Different Pavement Layers

MDT Structural Coefficients for Different Pavement Layers	
Layer	a_i
Plant Mix (PMBS)	0.41
CAC gravel	0.14
RAP/ Aggregate	0.12
CTB	0.20

Enter the PMS thickness based on the minimum PMS thickness shown in **Error! Reference source not found.** Exhibit E-12.

Exhibit E-12
Recommended Plant Mix
Thicknesses

ESALs (Daily)	PMS Thickness*
> 2000	0.70'
1000 - 2000	0.60' – 0.70'
501 - 1000	0.50' – 0.60'
201 - 500	0.40' – 0.50'
101 - 200	0.30' – 0.40'
0 - 100	0.30'*

*In certain cases 0.25' of PMS can be used for ½" or 3/8" mix, when budgets are constrained.

Use a trial-and-error approach to determine CAC thickness. 13.8 in. CAC yields an acceptable SN = 3.41 as shown in Exhibit E-13. MDT specifies pavement layer thicknesses in 0.05 ft. intervals, and rounding 13.8 in. up to the nearest 0.05 ft. yields 1.15 ft. The resulting pavement design for this project is 0.30 ft. PMS under laid by 1.15 ft. CAC.

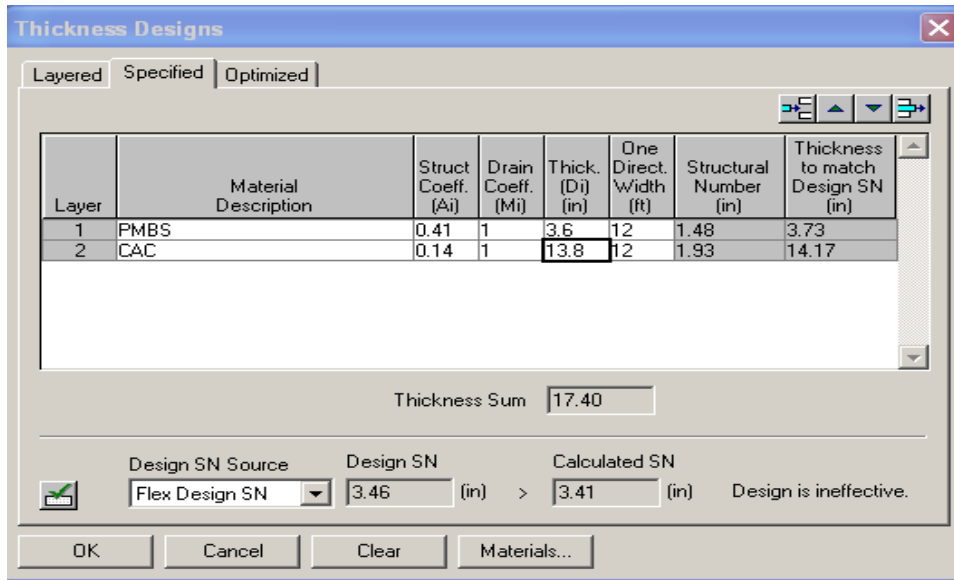

Exhibit E-13
DARWin completed thickness design

It should be noted, in Exhibit E-13 above, it states the design is ineffective. The calculated SN of 3.41 exceeds the low volume SN of 3.4 which is found in the low volume table.

Saving the DARWin Design File: It is important to save the DARWin design file with the correct file name and location so it can be revisited in the future. Click on “File” in the upper left hand corner of the main pane, and click save. A “Save As” pane will appear, click on “My Computer”, and the selection will change as shown in Exhibit E-14. Click on the “rdtr on ‘MDT Astro (astro)’” drive and click on the “DARWIN” folder. The “Save” button will now save the project in the standard location for Surfacing Design projects.

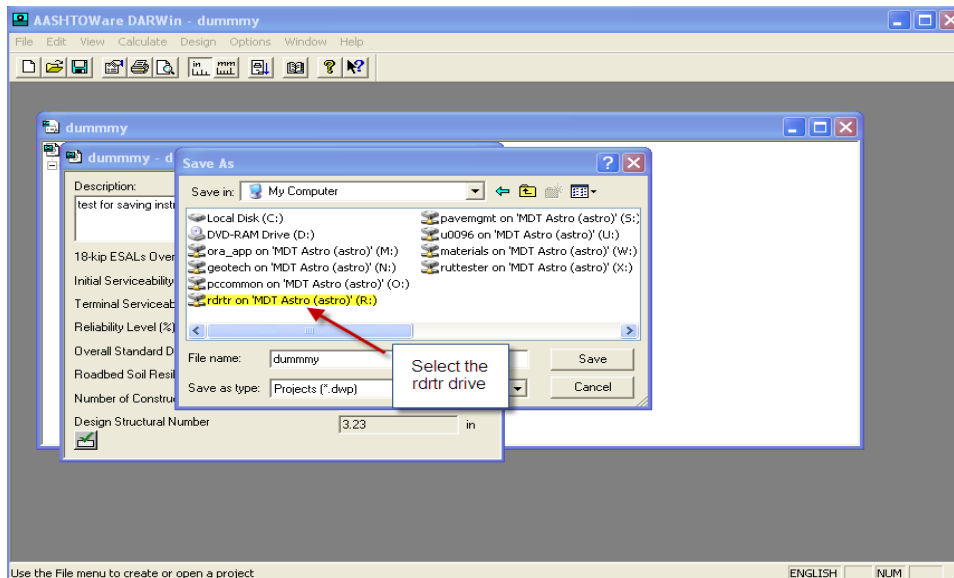

Exhibit E-14
DARWin Pane showing location of rdtr\projects\7digitUPN#.

The standard file name for DARWin design files is the 7-digit Construction Number (CN), and DARWin design files are designated by the file extension .dwp. For Jct US 2 – North of Chester, the file name is 6164000.dwp.

Step 5: Specify Pavement Materials

After the thickness design is completed, the next step is specifying pavement materials. This pavement consists of a Surface Treatment (if applicable), PMS, and CAC. Regarding the base layer, specifying the base material type is easy because MDT only uses CAC for aggregate base. The PMS type needs to be chosen first since it will determine the need for a surface treatment. PMS type is chosen based on PMS quantity and project type shown in Chapter 3, Section 3.1.1 **Error! Reference source not found.** and **Error! Reference source not found.** found earlier in this manual.

PMS Type Selection

First, calculate PMS tonnage. Based on discussion with the Road Design project manager, the finished roadway width will be 28 ft. Use the equation below to calculate PMS tonnage:

$$\begin{aligned} & \text{Project Length (miles) / project} * 5280 \text{ ft. / mile} * \text{Roadtop Width (ft.)} \\ & * \text{PMS thickness (ft.)} * 1 \text{ yd}^3/27 \text{ ft}^3 * 3855 \text{ lbs. / yd}^3 * 1 \text{ ton PMS / 2000 lbs.} \\ & = \text{tons PMS / project} \end{aligned}$$

OR:

$$\begin{aligned} & 9.0 \text{ miles / project} * 5280 \text{ ft. / mile} * 28' * 0.30' * 1 \text{ yd}^3/27 \text{ ft}^3 * 3855 \text{ lbs. / yd}^3 * 1 \text{ ton} \\ & \text{PMS / 2000 lbs.} \\ & = \mathbf{28,496 \text{ tons PMS / project}} \end{aligned}$$

Based on 28,496 tons, **Error! Reference source not found.** (found earlier in the manual) specifies that either ½ in. or ¾ in. Grade S Volumetric should be specified. **Error! Reference source not found.** (found earlier in the manual) specifies ¾ in. Grade S or Commercial Plant mix. Since both tables allow ¾ in. Grade S Volumetric, the designer should specify ¾ in. Grade S Volumetric. Climate or local project characteristics may lend themselves to ½ in. Grade S Volumetric mix with higher oil content to combat stripping.

PG Binder Selection

The criteria for picking PG Binder type is found earlier in this manual in Chapter 3, Section 3.1.1.

This reconstruction project has more than 50 daily ESALs; therefore, PG 64-28 is specified.

Should RAP be used?

Since this is a reconstruction of a gravel road, RAP will not be available.

Asphalt Content Selection

Project specific asphalt content is determined using the As Constructed Percent Asphalt map located on our web page. See Asphalt Content Selection **Error!**

Reference source not found.. Based on the Asphalt Map, 5.2% asphalt content is estimated.

Selecting Surface Treatment

This project has an AADT = 360 and a 70 mph posted speed. Based on Chapter 11, Exhibit 11-2, Type I chip seal will be specified since this is a newly constructed road with no rutting, high traffic speed, and low traffic volume.

Step 6: Sending the Pavement Design Memorandum

The last task is to save the surfacing design memorandum to the document management system and to send an email link to Road Design staff via email. Exhibit E-15 shows the surfacing design memorandum for this project. In practice, both the Pavement Design engineer and designer sign the memorandum to the right of their printed names. Verify that the correct distribution has been used. After completing the surfacing design memorandum in Microsoft Word, save the .docx file to the Surfacing Design Unit shared drive. Also, save the file as *.*.pdf file to be uploaded to the document management system. Appendix C outlines the steps to name the file and upload the document. Projects designed by a consultant will be handled within the corresponding activity in the appropriate flowchart.

If changes occur to the Preliminary Surfacing Design Memorandum, then Surfacing Design Unit will provide a Final Surfacing Design Memorandum.

Once the memorandum has been submitted for distribution and saved, the EPS activity may be carded off.

Exhibit E-15 Example Preliminary Surfacing Design Memorandum

Montana Department of Transportation Helena, MT 59620-1001	
Memorandum	
To:	Paul Ferry, P.E. Highways Engineer
Thru:	Daniel W. Hill, P.E. Pavement Analysis Engineer
From:	Gregory D. Zeihen, P. E. Pavement Research Engineering Specialist
Date:	7/18/2013
Subject:	STPS 409-1(7)0 Jct U. S. 2 – North of Chester CN 6164
Preliminary surfacing recommendations (surfacing activity 600) for the above project are listed below:	
■ Surfacing Section No. 1 – Reconstruction, BOP to just past <u>Gaylon</u> Grain Terminal (RP 0.6)	
----- Type I Chip Seal	
0.30' Plant Mix Bituminous Surfacing, Grade S	
<u>1.15'</u> Crushed Aggregate Course	
1.45'	Design R-value = 5
Surfacing Section No. 2 – Reconstruction, past <u>Gaylon</u> Grain Terminal (RP 0.6) to EOP (RP 9.0)	
----- Type I Chip Seal	
0.30' Plant Mix Bituminous Surfacing, Grade S	
<u>0.75'</u> Crushed Aggregate Course	
1.05'	Design R-value = 5
Surfacing design sections are based on traffic data indicating 58 ESALs, and 12 ESALs, respectively. Grade S ¾" plant mix surfacing with PG 64-28 binder and 5.2% asphalt content is recommended. R-values taken from the soil survey have been used to determine surfacing thickness. Surface Design recommends the District review soil <u>gqj</u> information prior to and during construction. Areas of concern and possible borrow areas should have additional soil samples submitted for R-value testing. Please contact me with questions regarding this recommendation.	
DWH:GZ	
cc:	D. Hand, P.E. D. Krings, P.E. S. Prinzing, P.E. Surfacing File Materials Bureau File Geotechnical File



Appendix F

1993 AASHTO Spreadsheet

Solution

AASHTO DARWin 3.1 (Design, Analysis, and Rehabilitation for Windows) is a computer program based on a design equation presented in the AASHTO Guide for Design of Pavement Structures 1993. Prior to the introduction of modern computing technology, this equation was solved by a nomograph using the following variables:

Reliability: The probability that a pavement section designed using this process will perform satisfactorily over the traffic and environmental conditions for the design period. This varies based on potential user cost incurred for failure and ranges from 70% to 95%.

Overall Standard Deviation: A statistical parameter used in conjunction with reliability to account for variation in traffic prediction. This value is held constant at 0.45.

Total 18-kip ESALs over Pavement Design Life: This parameter is provided by the Traffic Section of MDT and accounts for anticipated truck traffic over time. The input is the traffic for a 20-year design meaning the daily ESALs reported must be multiplied by 365 days/year and 20 years.

The Delta PSI or change in serviceability index: The difference between initial serviceability, typically 4.2 in Montana, and terminal serviceability, typically 2.5. This value is thus held constant at 1.7.

Roadbed Soil Resilient Modulus: A measure of material stiffness obtained by laboratory testing or non-destructive testing with a falling weight deflectometer. This can be related to R-values mathematically.

For more details on these parameters and appropriate values, see Chapter 5.

The original DARWin 3.1 has been rendered obsolete by updates in desktop computer operating systems. As this method has worked well for MDT, the

Surfacing Design Unit developed a spreadsheet version of DARWin to preserve the continuity of pavement design at MDT. Exhibit F-1 shows an example spreadsheet.

The blank worksheet is located in at the following website and is titled "0000_AASHTO_1993_PAVEMENTDESIGNEQUATION_V1.2_TEMPLATE.xlsx":

[DARWin Spreadsheet](#)

Use of this spreadsheet is fairly straightforward. In the upper portion of the spreadsheet, gray cells are inputs, and light blue cells are calculated quantities. The UPN number, Route/Project Number, and Name are entered in the upper left under column B. The Date of Run automatically resets to the current date when a sheet is opened. Next, under the heading labelled Traffic, enter the daily ESALs as reported from traffic, or another source in cell B11. Both yearly and 20-year ESALs will automatically be calculated. As a side note, the 20 year ESALs may be changed by selecting the cell, and changing the multiplier to, for instance, 30 for 30-year bridge ends. Now, under the "Demand" header, a note regarding the type of section may be entered in cell B16. This is optional, but is helpful to remind the designer what sort of typical he is preparing, for example CAC, CTB or the like. Cell B17 contains the R-value used in design, and this is related to the Mr in cell B25 through the equation in Chapter 5, but is not automatically calculated owing to the inherent variability in this value. The designer must calculate or select the appropriate R-value. The reliability is entered in cell B18 and is determined as discussed in Chapter 5, Section 5.5.3, based on the type of route. The standard deviation (So) and the DeltaPSI, as mentioned above, are usually not changed, and are entered in cells B19 and B20. A subgrade resilient modulus value (Mr) corresponding to the R-value in B17 is entered in B21 (in psi). The final input, SNdes is the design structural number, and this may either be estimated or left blank, as it will be calculated using the Data tab \What if analysis function of the spreadsheet. Exhibit F-2 shows a summary of the previous information.

To calculate the SNdes, place the cursor on cell B23 (W18) and select it. Then go to the "Data" tab at the top of the spreadsheet, and select "What-If Analysis" in the Forecast box towards the center right (Exhibit F-1). From the What-If Analysis drop-down menu, select "Goal Seek", and this will give you the calculation box shown in Exhibit F-4. In the "To value" box in the middle, type in the 20-year ESAL value from cell B13, select the little up arrow at the end of the "By changing cell" box, and then select cell B22 and hit the OK button. This will generate the SNdes for the correct number of 20-year ESALs as in Exhibit F-5. Select the "OK" button a second time and the Goal Seek Status function box will disappear.

Exhibit F-1 Example of MDT-developed spreadsheet utilizing the DARWin AASHTO 1993 flexible design equation.

UPN	8568									
Route	STPS 494-1(1)(4)1									
Name	Slide Repair - S of Plevna									
Date of Run	1/2/2018									
	Use Goal Seek (What If Analysis) to match this row		Iterate SNEDES, to set W18 to 20 Year ESAL (Independent Variable)			Use Goal Seek (What If Analysis) to match this row (Dependant Variable)				
Typical Section	1	2	3	4	5	6	7	8	9	10
Traffic										
Daily ESAL	14	14								
Yearly ESAL	5110	5110	0	0	0	0	0	0	0	0
20 Year ESAL	102200	102200	0	0	0	0	0	0	0	0
Demand										
Note	CAC	SP BRW								
Note	R=5	R=30	R=5							
Reliability	75	75	75							
So	0.45	0.45	0.45							
DeltaFSI	1.7	1.7	1.7							
Asf	3500	12000	3500							
SNEDES	1.25	1.24	3.18							
W18	858	14600	135512	#N/A	#N/A	#N/A	#N/A	#N/A	#N/A	#N/A
Z	-0.674	-0.674	-0.674	#N/A	#N/A	#N/A	#N/A	#N/A	#N/A	#N/A
ESAL	0	2	25	#N/A	#N/A	#N/A	#N/A	#N/A	#N/A	#N/A
Life	20.0	20.0	20.0	#N/A	#N/A	#N/A	#N/A	#N/A	#N/A	#N/A
Capacity										
a1	0.41	0.41	0.41	0.41	0.41	0.41	0.41	0.41	0.41	0.41
D1 (in)				4.8						
SN1	0.0	0.0	2.0	0.0	0.0	0.0	0.0	0.0	0.0	0.0
a2	0.14	0.14								
m2	1	1	1	1	1	1	1	1	1	1
D2 (in)										
SN2	0.0	0.0	0.0	0.0	0.0	0.0	0.0	0.0	0.0	0.0
a3										
m3	1	1	1	1	1	1	1	1	1	1
D3 (in)										
SN3	0.0	0.0	0.0	0.0	0.0	0.0	0.0	0.0	0.0	0.0
a4										
m4	1	1	1	1	1	1	1	1	1	1
D4 (in)										
SN4	0.0	0.0	0.0	0.0	0.0	0.0	0.0	0.0	0.0	0.0
Sntot = SN1-SN2-SN3-SN4	0.00	0.00	1.97	0.00	0.00	0.00	0.00	0.00	0.00	0.00
Traffic Chk, W18=20 Yr ESAL	NG	NG	NG	#N/A	#N/A	#N/A	#N/A	#N/A	#N/A	#N/A
SN Check	NG	NG	NG	NG	NG	NG	NG	NG	NG	NG
Design Check	ERROR	ERROR	ERROR	#N/A	#N/A	#N/A	#N/A	#N/A	#N/A	#N/A
Layer 1 (ft)	0.00	0.00	0.40	0.00	0.00	0.00	0.00	0.00	0.00	0.00
Layer 2 (ft)	0.00	0.00	0.00	0.00	0.00	0.00	0.00	0.00	0.00	0.00
Layer 3 (ft)	0.00	0.00	0.00	0.00	0.00	0.00	0.00	0.00	0.00	0.00
Layer 4 (ft)	0.00	0.00	0.00	0.00	0.00	0.00	0.00	0.00	0.00	0.00
Total	0.00	0.00	0.40	0.00	0.00	0.00	0.00	0.00	0.00	0.00
Layer 1 (mm)	0	0	122	0	0	0	0	0	0	0
Layer 2 (mm)	0	0	0	0	0	0	0	0	0	0
Layer 3 (mm)	0	0	0	0	0	0	0	0	0	0
Layer 4 (mm)	0	0	0	0	0	0	0	0	0	0
Total	0	0	122	0	0	0	0	0	0	0

Instructions:

- 1 Enter design inputs into GRAY CELLS
- 2 A solution to the 1993 AASHTO Equation 1.1.2 in Section I-5 is obtained by iterating "SNEDES" until "W18" = "20 Year ESAL".
- 3 The iteration can be done manually, or by using the 'Goal Seek' function in Excel. This is done by going to the **Data Tab** and selecting **What-If Analysis /Goal Seek**
- 4 Once the solution is found and the value for 20 Year ESAL (Row 13) is equal to the value W18 (Row 22), The '**Demand**' or required Structural Number (SNEDES) is given in row 21.
- 5 Next, in the '**Capacity**' section, enter in the typical section coefficients and thickness (units = inches)
- 6 The typical section is adequate if **Sntotal (row 39)** is greater than or equal to **SNEDES** (row 21). Row 40 will report "DESIGN OK" if the typical section is structurally adequate, and "ERROR" if the typical is underdesigned.

= Input
 = Calculated Value
 = Match value of these two rows

Exhibit F-2 Input section of MDT spreadsheet for Demand parameters and project information.

UPN	8568						
Route	STPS 494-1(1(4)1						
Name	Slide Repair - S of Plevna						
Date of Run	1/2/2018						
Typical Section	1	2	3	4	5	6	7
Traffic							
Daily ESAL	14	14					
Yearly ESAL	5110	5110	0	0	0	0	0
20 Year ESAL	102200	102200	0	0	0	0	0
Demand							
Note	CAC	SP BRW					
Note	R=5	R = 30	R=5				
Reliability	75	75	75				
So	0.45	0.45	0.45				
DeltaPSI	1.7	1.7	1.7				
Mr	3500	12000	3500				
SNDES	1.25	1.24	3.18				
W18	858	14600	185512	#N/A	#N/A	#N/A	#N/A
Zr	-0.674	-0.674	-0.674	#N/A	#N/A	#N/A	#N/A
ESAL	0	2	25	#N/A	#N/A	#N/A	#N/A
Life	20.0	20.0	20.0	#N/A	#N/A	#N/A	#N/A
Capacity							
a1	0.41	0.41	0.41	0.41	0.41	0.41	0.41

Exhibit F-3 Data Tab and What-If Analysis selections.

Instructions:

- 1 Enter design inputs into GRAY CELLS
- 2 A solution to the 1993 AASHTO Equation 1.1.2 in Section I-5 is obtained by iterating "SNDES" until "W18" = "20 Year ESAL".
- 3 The iteration can be done manually, or by using the 'Goal Seek' function in Excel. This is done by going to the **Data Tab** and selecting **What-If Analysis /Goal Seek**
- 4 Once the solution is found and the value for 20 Year ESAL (Row 13) is equal to the value W18 (Row 22), The **Demand** or required Structural Number (SNDES) is given in row 21.
- 5 Next, in the **Capacity** section, enter in the typical section coefficients and thickness (units = inches)
- 6 The typical section is adequate if $SN_{Total} (row 39)$ is greater than or equal to SNDES (row 21). Row 40 will report "DESIGN OK" if the typical section is structurally adequate, and "ERROR" if the typical is underdesigned.

= Input
 = Calculated Value
 = Match value of these two rows

Exhibit F-4 Goal seek function before hitting the “OK” button.

The screenshot shows an Excel spreadsheet with the following data:

	A	B	C	D	E	F	G	H	I
1	UPN	8568							
2	Route	STPS 494-1(1(4)1							
3	Name	Slide Repair - S of Plevna							
4	Date of Run	1/2/2018							
8	Typical Section	1	2	3	4	5	6	7	8
10	Traffic								
11	Daily ESAL	14	14						
12	Yearly ESAL	5110	5110	0	0	0	0	0	0
13	20 Year ESAL	102200	102200	0	0	0	0	0	0
15	Demand								
16	Note	CAC	SP BRW						
17	Note	R=5	R = 30	R=5					
18	Reliability	75	75	75					
19	So	0.45	0.45	0.45					
20	DeltaPSI	1.7	1.7	1.7					
21	Mr	3500	12000	3500					
22	SNdes	1.25	1.24	3.18					
23	W18	858	14600	185512	#N/A	#N/A	#N/A	#N/A	#N/A
24	Zr	-0.674	-0.674	-0.674	#N/A	#N/A	#N/A	#N/A	#N/A
25	ESAL	0	2	25	#N/A	#N/A	#N/A	#N/A	#N/A
26	Life	20.0	20.0	20.0	#N/A	#N/A	#N/A	#N/A	#N/A

The Goal Seek dialog box is open, showing:

- Set cell: B23
- To value of: 102200
- By changing cell: B22

Exhibit F-5 Goal seek function after pressing the “OK” button, showing the calculated SNdes to be matched with the “Capacity” section.

The screenshot shows the same Excel spreadsheet as Exhibit F-4, but with the following updates:

	A	B	C	D	E	F	G	H	I
1	UPN	8568							
2	Route	STPS 494-1(1(4)1							
3	Name	Slide Repair - S of Plevna							
4	Date of Run	1/2/2018							
8	Typical Section	1	2	3	4	5	6	7	8
10	Traffic								
11	Daily ESAL	14	14						
12	Yearly ESAL	5110	5110	0	0	0	0	0	0
13	20 Year ESAL	102200	102200	0	0	0	0	0	0
15	Demand								
16	Note	CAC	SP BRW						
17	Note	R=5	R = 30	R=5					
18	Reliability	75	75	75					
19	So	0.45	0.45	0.45					
20	DeltaPSI	1.7	1.7	1.7					
21	Mr	3500	12000	3500					
22	SNdes	2.88	1.24	3.18					
23	W18	102200	14600	185512	#N/A	#N/A	#N/A	#N/A	#N/A
24	Zr	-0.674	-0.674	-0.674	#N/A	#N/A	#N/A	#N/A	#N/A
25	ESAL	14	2	25	#N/A	#N/A	#N/A	#N/A	#N/A
26	Life	20.0	20.0	20.0	#N/A	#N/A	#N/A	#N/A	#N/A

The Goal Seek Status dialog box is open, showing:

- Goal Seeking with Cell B23 found a solution.
- Target value: 102200
- Current value: 102200

The colored cells in the lower portion labeled “Capacity” are also input cells. The a1 cells hold the structural coefficient for each different type of surfacing. MDT typical values for these are presented in the far right set of colored cells. A more complete list is presented in Chapter 5, Exhibit 5-6. Layer thickness in inches is then entered below the structural coefficient (rows labeled D1-D4), and the SN for each layer is calculated at the bottom cell of each colored section (Exhibit F-6, rows labeled SN1-4). A convenient conversion of tenths of feet to inches is included in the spreadsheet tab at the lower right. The rows containing m1 through m4 are drainage coefficients for the base units, generally left at 1. Appropriate thicknesses of both plant mix and base materials are discussed in Chapter 5. This portion of the design is a trial-and-error method, balancing the plant mix thickness and the various base thicknesses until the green “Design OK” cell appears in the Design Check row (Exhibit F-6). Up to ten different sections may be designed in each separate column and up to four different layers may be used. Instructions for use are also included on the right side of the spreadsheet (Exhibit F-1 and F-3).

Exhibit F-6 Capacity portion of spreadsheet showing locations for structural coefficients and layer thicknesses.

Life	20.0	20.0	20.0	#N/A	#N/A	#N/A	#N/A	#N/A	#N/A	#N/A	#N/A	
Capacity												
a1	0.41	0.41	0.41	0.41	0.41	0.41	0.41	0.41	0.41	0.41	0.41	a1 = 0.41 for PMS a1 = 0.30 for CIR
D1 (in)	3.6	0.0	0.0	0.0	0.0	0.0	0.0	0.0	0.0	0.0	0.0	
SN1	1.5	0.0	0.0	0.0	0.0	0.0	0.0	0.0	0.0	0.0	0.0	
a2	0.14	0.14	1	1	1	1	1	1	1	1	1	a1 = 0.41 for PMS a2 = 0.14 for CAC a2 = 0.20 for CTB a2 = 0.30 for CCPR
m2	1	1	1	1	1	1	1	1	1	1	1	
D2 (in)	10.2	0.0	0.0	0.0	0.0	0.0	0.0	0.0	0.0	0.0	0.0	
SN2	1.4	0.0	0.0	0.0	0.0	0.0	0.0	0.0	0.0	0.0	0.0	
a3	1	1	1	1	1	1	1	1	1	1	1	a1 = 0.41 for PMS a2 = 0.14 for CAC a2 = 0.20 for CTB a2 = 0.30 for CCPR
m3	1	1	1	1	1	1	1	1	1	1	1	
D3 (in)	0.0	0.0	0.0	0.0	0.0	0.0	0.0	0.0	0.0	0.0	0.0	
SN3	0.0	0.0	0.0	0.0	0.0	0.0	0.0	0.0	0.0	0.0	0.0	
a4	1	1	1	1	1	1	1	1	1	1	1	a1 = 0.41 for PMS a2 = 0.14 for CAC a2 = 0.20 for CTB a2 = 0.30 for CCPR
m4	1	1	1	1	1	1	1	1	1	1	1	
D4 (in)	0.0	0.0	0.0	0.0	0.0	0.0	0.0	0.0	0.0	0.0	0.0	
SN4	0.0	0.0	0.0	0.0	0.0	0.0	0.0	0.0	0.0	0.0	0.0	
Sntot = SN1+SN2+SN3+SN4	2.90	0.00	0.00	0.00	0.00	0.00	0.00	0.00	0.00	0.00	0.00	
Traffic Chk W18=20 Yr ESAL	OK	NG	NG	#N/A	#N/A	#N/A	#N/A	#N/A	#N/A	#N/A	#N/A	
SN Check	OK	NG	NG	NG	NG	NG	NG	NG	NG	NG	NG	
Design Check	DESIGN OK	ERROR	ERROR	#N/A	#N/A	#N/A	#N/A	#N/A	#N/A	#N/A	#N/A	
Layer 1 (ft)	0.30	0.00	0.00	0.00	0.00	0.00	0.00	0.00	0.00	0.00	0.00	
Layer 2 (ft)	0.85	0.00	0.00	0.00	0.00	0.00	0.00	0.00	0.00	0.00	0.00	
Layer 3 (ft)	0.00	0.00	0.00	0.00	0.00	0.00	0.00	0.00	0.00	0.00	0.00	
Layer 4 (ft)	0.00	0.00	0.00	0.00	0.00	0.00	0.00	0.00	0.00	0.00	0.00	
Total	1.15	0.00	0.00	0.00	0.00	0.00	0.00	0.00	0.00	0.00	0.00	

Appendix G

Acronyms

Acronym	Definition
a_{BASE} , a_{PMS} , a_{SUB}	The average effective structural coefficient of the existing Base Course, PMS, and Subbase Course layers
AADT	Average Annual Daily Traffic
AASHO	American Association of State Highway Officials
AASHTO	American Association of State Highway and Transportation Officials
AC	Asphalt Concrete
ACPA	American Concrete Paving Association
ADT	Annual Daily Traffic
AGR	Alignment and Grade Review
ARRA	Asphalt Recycling and Reclaiming Association
BARM	Basics in Asphalt Recycling Manual
C	Conversion factor to convert FWD back-calculated subgrade modulus to laboratory subgrade modulus
CAC	Crushed Aggregate Course
CBR	California Bearing Ratio
CCPR	Cold Central Plant Recycling
CE	Construction Engineering
CIR	Cold In-Place Recycling
CRCP	Continuously Reinforced Concrete Pavement
CTB	Cement-Treated Base
CTS	Crushed Top Surfacing
d_{BASE} , d_{PMS} , d_{SUB}	Average thicknesses of the existing Base Course, PMS, and Subbase Course
D	The total thickness of all pavement layers above the subgrade.
DARWin	Design, Analysis, and Rehabilitation for Windows
DCP	Dynamic Cone Penetrometer

Acronym	Definition
DNRC	Department of Natural Resources
d_o	The FWD deflection directly under the load plate
DPM	Design Project Manager
E	Elastic Modulus, Young's Modulus
E_{FWD}	Pavement layer or subgrade elastic modulus back-calculated from FWD data
E_p	Effective Modulus of the pavement layers above the subgrade
ESAL	Equivalent Single Axle Load
EPS	Engineering Project Scheduler
FDR	Full Depth Reclamation
FHWA	Federal Highway Administration
FWD	Falling-Weight Deflectometer
GHz	Gigahertz
GPR	Ground Penetrating Radar
GPS	Global Positioning System
HF	High Float
HIR	Hot In-Place Recycling
HMA	Hot Mix Asphalt
IGGA	International Grooving and Grinding Association
IRI	International Roughness Index
ISSA	International Slurry Surfacing Association
JPCP	Jointed Plain Concrete Pavement
LCCA	Life-Cycle Cost Analysis
MDT	Montana Department of Transportation
M-E Design	Mechanistic Empirical Design
MEPDG	Mechanistic Empirical Design Guide
MHz	Megahertz
M_r	Resilient Modulus
$M_{r(des)}$	Design Resilient Modulus
$M_{r(lab)}$	Laboratory Resilient Modulus
n	Number of individual PMS lifts within the existing pavement
NCHRP	National Cooperative Highway Research Program

Acronym	Definition
NCPP	National Center for Pavement Preservation
NCPTC	National Concrete Pavement Technology Center
NDT	Non-Destructive Testing
NHS	National Highway System
NMAS	Nominal Maximum Aggregate Sizes
NPV	Net Present Value
OGFC	Open Graded Friction Course
P	The actual FWD load taken from FWD deflection data
P200	Percent Passing the Number 200 Sieve
PCCP	Portland Cement Concrete Pavement
PFR	Preliminary Field Review
PG	Performance Graded
PI	Plasticity Index
PIH	Plan-In-Hand
PMBB	Plant Mix Bituminous Base
PMBS	Plant Mix Bituminous Surfacing
PMS	Plant Mix Surfacing
P_o	Initial Design Serviceability Index
PSI	Pavement Serviceability Index
P_t	Design Terminal Serviceability Index
PvMS	Pavement Management System
Q&A	Question and Answer
Q/A	Quality Assurance
Q/C	Quality Control
RAP	Recycled Asphalt Pavement
S&C	Seal and Cover
SN	Structural Number
S_o	Combined Standard Error of the traffic prediction and performance prediction
SOW	Scope of Work

Acronym	Definition
SN_{des}	Design Structural Number
SN_{dgn}	Structural Number for future traffic loading
SN_{eff}	Effective Structural Number
SN_{ol}	Structural Number deficiency between existing pavement and that needed for future traffic
$SN_{req'd}$	Required Structural Number
SPT	Standard Penetration Test
TxDOT	Texas Department of Transportation
UGPTI	Upper Great Plains Transportation Institute
VE	Value Engineering
W_{18}	Predicted number of 80 kN ESALs
Z_r	Standard Normal Deviate

Websites

Title	Website	Chapter Reference
MDT-Designed Projects	http://mdtinfo.mdt.mt.gov/eiss/flowcharts.shtml	2
Consultant-Designed MDT Projects	http://mdtinfo.mdt.mt.gov/other/webdata/external/EISS/flowcharts/consultant_design.pdf	2
Pavement Preservation Flow Chart	http://mdtinfo.mdt.mt.gov/other/webdata/internal/EISS/flowcharts/pavement_preservation.pdf	2
MDT Annual Pavement Performance and Conditions Report	https://app.mt.gov/pvms/	2
MDT Policy for Scoping Pavement Preservation Projects	https://www.mdt.mt.gov/publications/docs/GUIDELINES-FOR-PAVEMENT-PROJECTS.PDF	2
MDT Design Memorandums	http://www.mdt.mt.gov/business/consulting/design_memos.shtml	2
MDT Construction Memorandums	https://www.mdt.mt.gov/business/contracting/memos/const_memos.shtml	2
MDT Map Gallery	http://www.mdt.mt.gov/publications/map-gallery.shtml	3
Montana GIS Map	http://www.arcgis.com/home/webmap/viewer.html?webmap=13f5cb432fa44bfd9018895aa7ebcee1	3
MDT Geosynthetic Research Report	http://www.mdt.state.mt.us/research/	3
MDT Interactive Maps	http://www.mdt.mt.gov/publications/maps.shtml	5
Triaxial Test	https://www.pavementinteractive.org/reference-desk/testing/aggregate-tests/triaxial-test/	5
Study of Measurement of Subgrade Soil Parameters	http://www.mdt.mt.gov/other/webdata/external/research/docs/research_projects/subgrade_soil_eval/final_report.pdf	5
MDT Construction Memorandum for R-Value Testing of Finished Subgrade	http://www.mdt.mt.gov/other/webdata/external/const/const_memo/2005/r_value_testing_of_finished_subgrade.pdf	5
Guidelines for Nomination and Development of Pavement Projects	https://www.mdt.mt.gov/publications/docs/GUIDELINES-FOR-PAVEMENT-PROJECTS.PDF	6
MDT Detailed Drawings	http://www.mdt.mt.gov/business/contracting/detailed_drawings.shtml	9
MDT CIR Project Report	http://mdtinfo.mdt.mt.gov/other/webdata/external/pavementanalysis/SurfacingDesign/Reports/Cold-In-Place-Recycling/CIR-ConstructionReviewReports/2015-CIR-ComprehensiveReport.pdf	11
Pavement Interactive	http://www.pavementinteractive.org/	11
National Center for Pavement Preservation	http://www.pavementpreservation.org/	11
FHWA Pocket Guides and Publications	https://www.pavementpreservation.org/technical-resources/fhwa-preservation-brochures/	11
International Grooving and Grinding Association	http://www.igga.org/	11
International Slurry Surfacing Association	http://www.slurry.org/	11
National Concrete Pavement Technology Center	http://www.cptechcenter.org/ http://www.cptechcenter.org/technical-library/documents/preservation_guide_2nd_ed_508_final.pdf	11
Asphalt Recycling and Reclaiming Association	http://www.arra.org/	11
Asphalt Institute	http://www.asphaltinstitute.org/	11
American Concrete Paving Association	http://www.acpa.org/	11

Title	Website	Chapter Reference
UGPTI Traffic Predictions	http://www.mdt.mt.gov/other/webdata/external/research/docs/research_p/roj/oil_boom/final_report.pdf	13
Project Stripping Report	https://app.mdt.mt.gov/samples/sample/search	14
PathWeb	http://pathweb.mdthq.mt.ads/pathweb/	14
Ride and Rut Information	https://app.mt.gov/pvms/pdf/2011_pavement_report_development.pdf	14
MDT's Pavement Analysis Section	http://mdtinfo.mdt.mt.gov/materials/pave-analysis/default.shtml	14
Additional Resources	http://mdtinfo.mdt.mt.gov/mdt/manuals.shtml	14
Research Link	http://mdtinfo.mdt.mt.gov/research/	14
NCHRP Report 703 - Guide for Pavement-Type Selection	http://onlinepubs.trb.org/onlinepubs/nchrp/nchrp_rpt_703.pdf	15
FHWA Technical Advisory Use of Alternate Bidding for Pavement Type Selection	http://www.fhwa.dot.gov/pavement/t504039.cfm	15
FHWA Transportation Performance Management	http://www.fhwa.dot.gov/infrastructure/asstmgmt/lcca.cfm	15