

Exploration of UHPC Applications for Montana Bridges

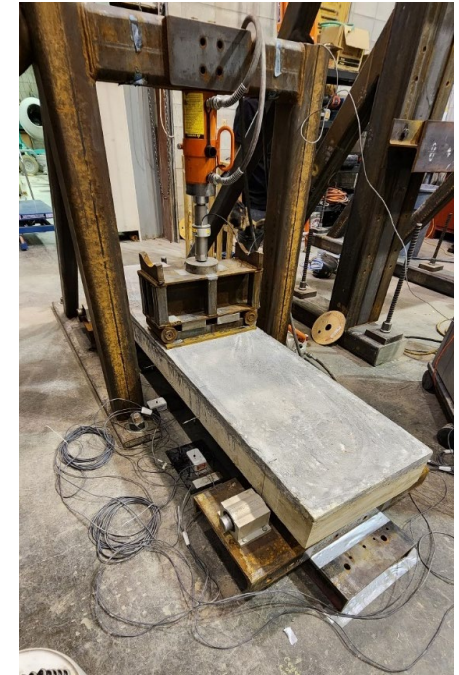
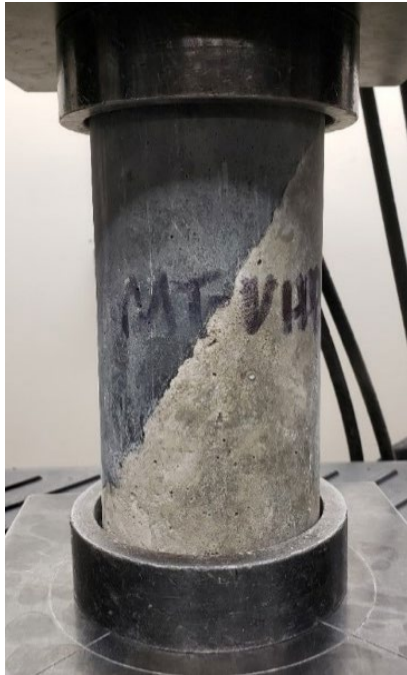

Kirsten Matteson, PhD
Michael Berry, PhD
James Starke, MS

UHPC Project Background

- Phase 1 – Feasibility
 - We can make UHPC with materials readily available in Montana
- Phase 2 – Field Application and Sensitivity Study
 - Changes in constituent materials and batch size
 - Bonding properties and pull-out strengths
- Phase 3 – Implementation
 - First use of MT-UHPC for field cast joints
 - Investigate constructability issues that may hinder use of MT-UHPC in future applications



Current Project's Scope



1. Literature Review
2. UHPC Overlay Projects, Material Specifications, and Implementation Issues
3. Material-Level Evaluation
4. Structural Testing

1. Literature Review

1. Literature Review

- UHPC has potential for use as a bridge deck overlay material
 - Several studies – Iowa State, New Mexico State, and Missouri S&T
 - Thixotropic mix design needed for cross slope and superelevation
 - Most other state DOT's using proprietary mixes and special equipment to mix and place overlays
 - Substrate concrete surface preparation required for adequate bond with UHPC overlays
- Steel girder repair has been proven with large scale testing
 - University of Connecticut
 - All UHPC repair methods were shown to increase capacity compared to undamaged girders.
 - FEA model developed

Previous UHPC Overlay Testing



2. UHPC Overlay Projects, Material Specifications, and Implementation Issues

FHWA Documentation

- Design and Construction of UHPC-Based Bridge Preservation and Repair Solutions (May 2022)
 - Summarized various overlay and repair projects
 - Provided recommendations for material specifications and construction considerations
 - Some examples: UHPC Overlay, UHPC deck header joints, UHPC construction joints, etc.

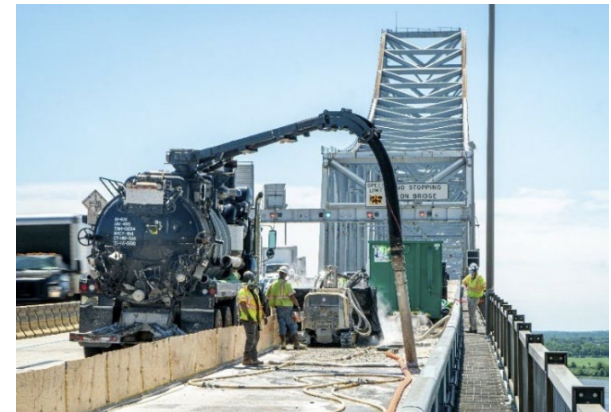

Existing UHPC overlay projects and Material Specifications

- Iowa, New Jersey, New Mexico, and New York
- Takeaways:
 - Importance of flow tests
 - Getting the deck to saturated-surface-dry (SSD)
 - Apply curing compound and tarping after casting
 - Diamond ground UHPC is typically final riding surface
 - Typically thinner overlays unless major deck rehabilitation
 - Some special equipment available
 - Inclusion of a placement plan



Mock-up Placement



3. Material-Level Evaluation

- Investigated 3 UHPC mixes
 - MT-UHPC
 - MT-UHPC with viscosity modifying admixture for thixotropy (MT-UHPC-T)
 - Proprietary thixotropic Ductal mix (Ductal-T)
- Experimental Testing
 - Compression Testing
 - Flexural Testing
 - Direct Tension Testing
 - Slant Shear Testing

Discussion on Thixotropy



Material Strengths

UHPC Type	Flow (in)		Compressive Strength, f'_c (ksi)			Ultimate Tensile Strength (ksi)		
	Static	Dynamic	7-Day	14-Day	28-Day	Measured	Predicted	Meas/Pred
MT-UHPC	10.25	-	14.3	15.1	17	3.37	0.978	3.45
MT-UHPC-T	4	5.5	11.6	-	15.4	2.8	0.931	3.01
Ductal	4	6.5	15.1	17.3	17.4	3.43	0.989	3.47

- Compression – ASTM C1856 and C39
- Flexure/Ultimate Tensile – ASTM C1609



Testing – Direct Tension

- Direct Tension – ASTM C1583
 - Create slab of substrate concrete
 - Prepare surfaces – typical, cross-hatch, and chipped
 - Apply overlay material
 - Core and prep samples
 - Test in MTS tension



Results – Direct Tension

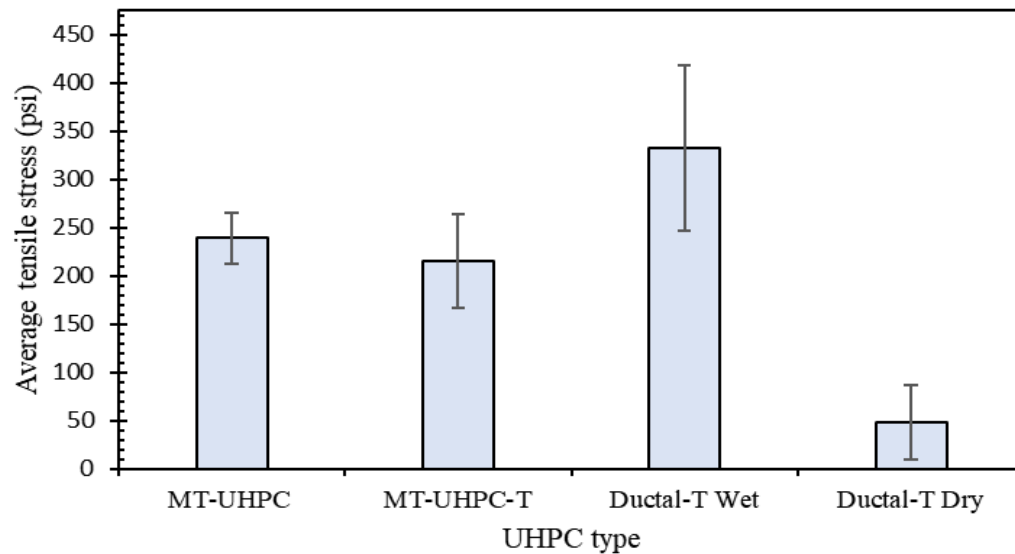

Testing – Slant Shear

- Slant Shear – ASTM C882
 - Create 30-degree angle cylinders
 - Prep surfaces (same typical as direct tension)
 - Fill remaining cylinder
 - Test in compression

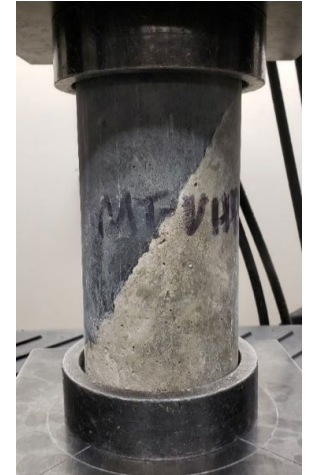

Results – Slant Shear

Sample Number	Minimum Bond Shear Strength (ksi)		
	MT-UHPC	MT-UHPC-T	Ductal-T
1	2.94	3.15	3.13*
2	2.77	3.33	3.26
3	2.75	3.31	3.3
4	2.82	3.37	3.16
Average	2.82	3.29	3.24
CoV	3.02%	2.94%	2.23%

*Bond Failure



Material Level Evaluation Key Takeaway

- Both thixotropic mixes demonstrated the desired behavior, but the MT-UHPC-T mix requires further refinement to optimize the UW-450 admixture dosage
- Mixing, workability, and overall consistency of Ductal-T was superior, and it is easier to acquire the large volumes needed for overlay from supplier
- Decided to move forward with Ductal for the structural testing

4. Structural Testing

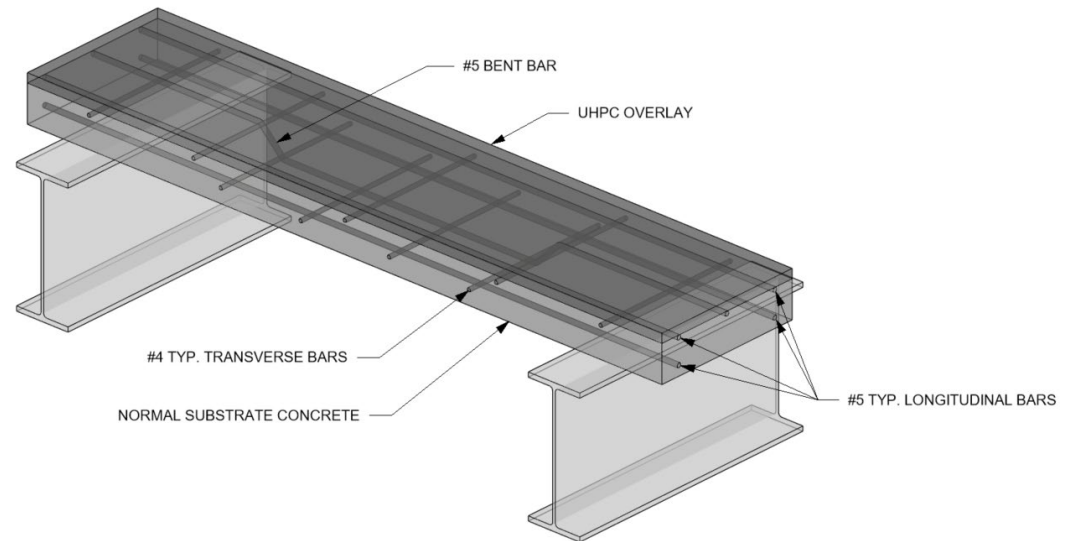

Structural Testing

- 5 slabs were constructed based on a section of the Fred Robinson Bridge in northeastern Montana
- The bridge has a weaker (~2 ksi) and thinner deck in need of repair
- Tested in 3-Point bending with load applied over a plate to represent a tire.

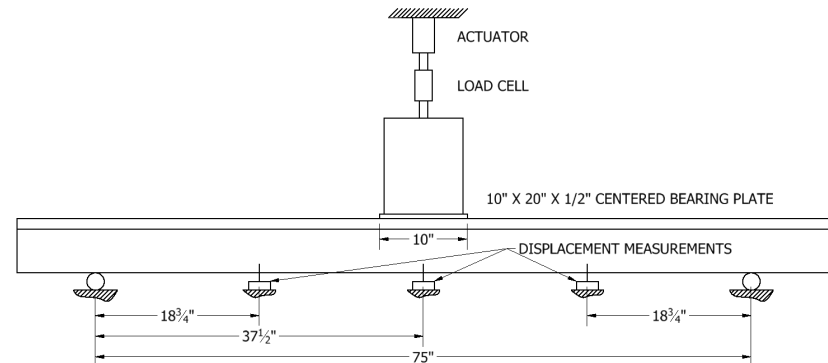
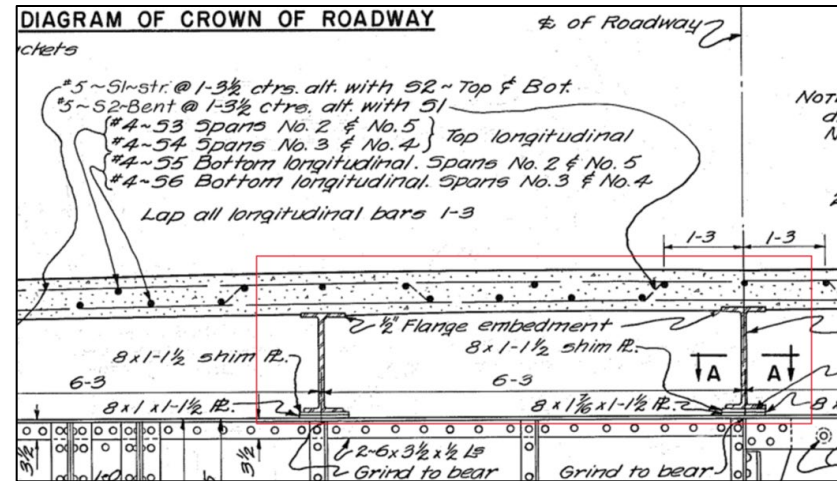

Slab Details

Overall goals when designing the specimens were to make comparisons of varying overlay thickness, concrete strengths, and subjecting the overlay to compression and tension

- Control
- O-PR1: *Overlay-Positive Regular 1*
- O-PR2: *Overlay-Positive Regular 2*
- O-PW: *Overlay-Positive Weak*
- O-NR: *Overlay-Negative Regular*

Slab Details

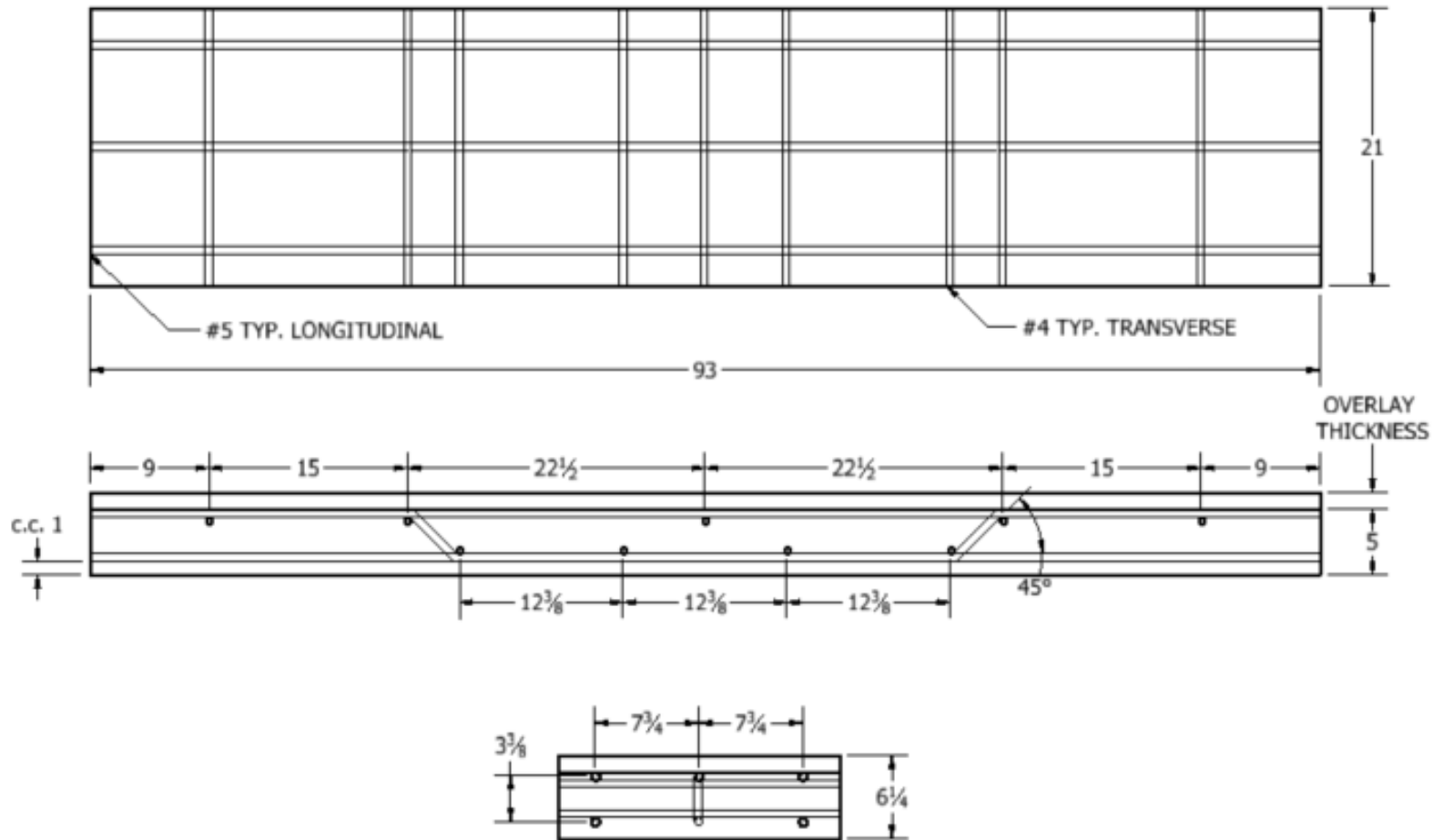

Casting Substrate Concrete

- Regular strength (4 ksi) substrate concrete was provided by Quality Ready Mix in Bozeman, MT
- The weak mix (2.7 ksi) substrate concrete was mixed using a mix design made at MSU
- Surface retarder was applied to all slabs except the control, and sprayed after about 20 hours



Casting UHPC Overlays

- Mixed in a fixed-drum, rotating fin high-shear mortar mixer (IMER Mortarman 360)
- All slabs except O-PW were cast 14 days after the substrate concrete had been cast
- Overlay for O-PW was cast after 3 days after the substrate concrete
- WR Meadows 1600 White curing compound was applied immediately after casting



Casting UHPC Overlays

- Curing compound was sprayed and scraped off after 24 hours
- UHPC had seeped in between the substrate and formwork and had to be chipped off.



Results

- Control
 - Behaved as expected
 - Failed in flexure due to concrete crushing
 - Max load of 21.5 kips
 - Good ductility

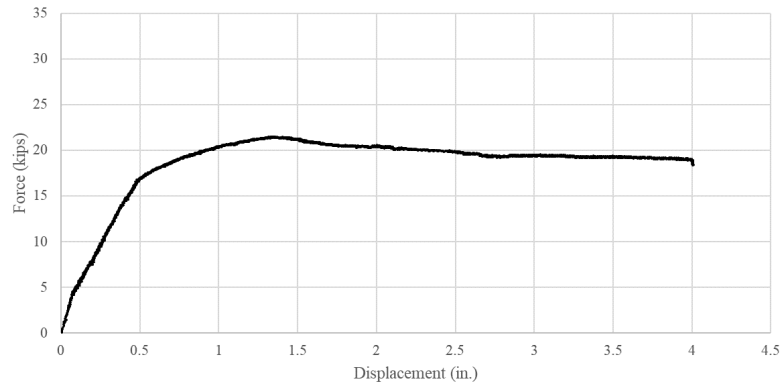
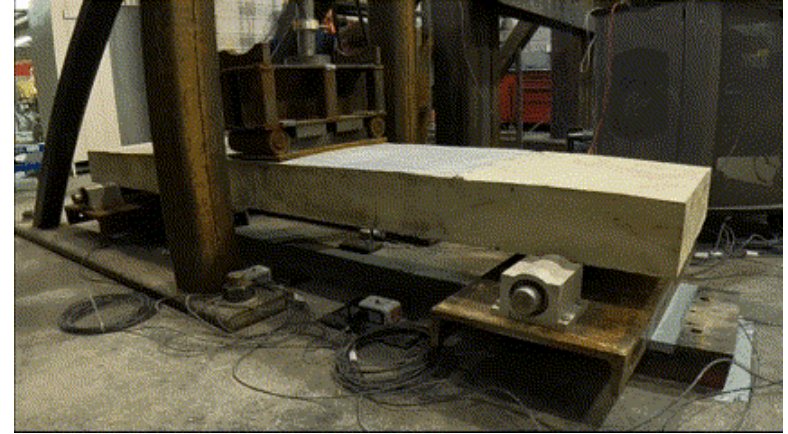

Results

- O-PR1
 - Failed (dropped in load) due to a shear crack but continued to sustain load
 - Max load of 29.4 kips
 - UHPC de-bonded with the shear crack and had a sudden drop in load

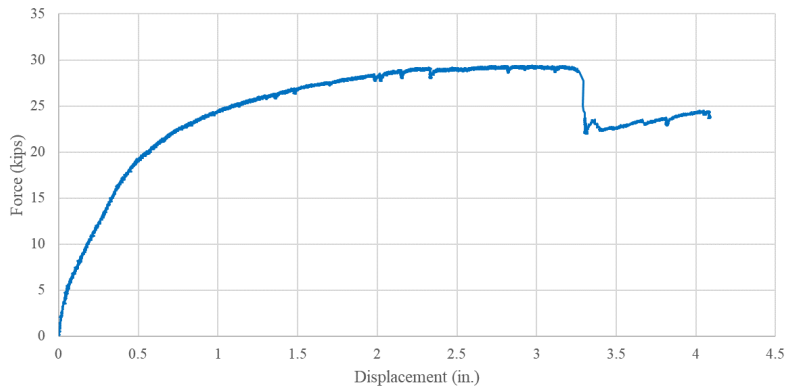
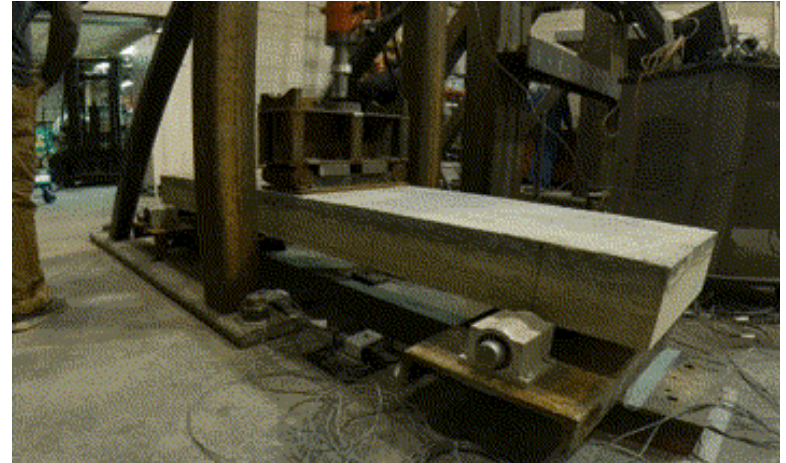

Results

- O-PR2
 - Failed when shear crack fully propagated through
 - Max load of 32.5 kips
 - Good ductility since no debonding occurred

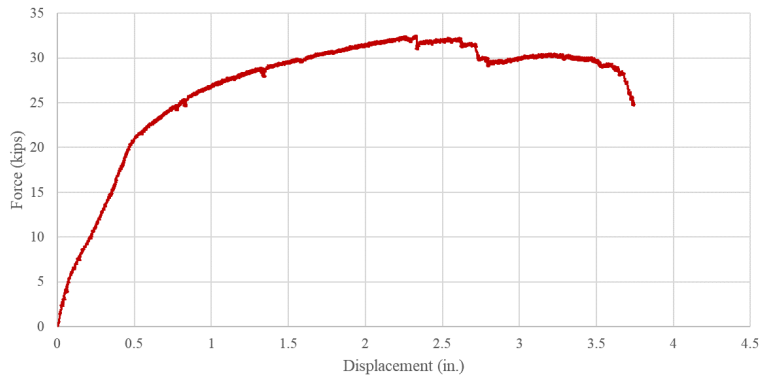
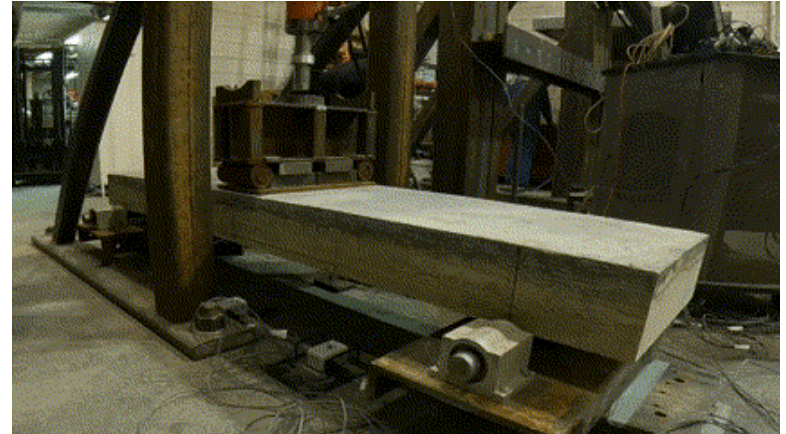

Results

- O-PW
 - Failed when shear crack fully propagated through
 - Max load of 22.9 kips
 - Sudden drop in load due to shear crack propagation

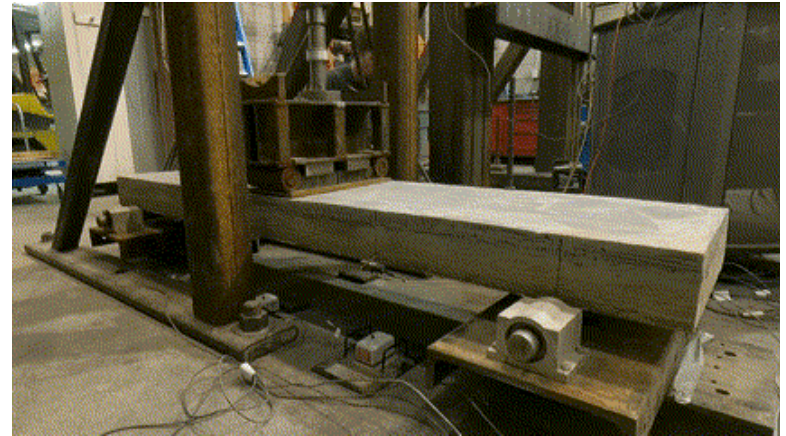
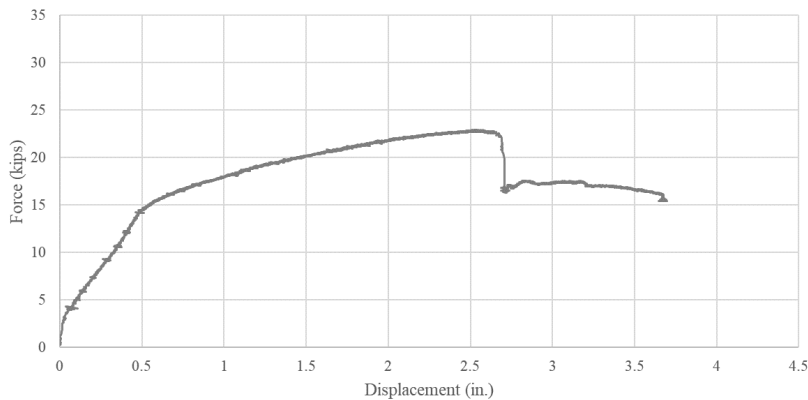

Results

- O-NR
 - Unique behavior due to UHPC loading in tension
 - Max load of 29.8 kips
 - Post-crack moment capacity is significantly less than cracking moment

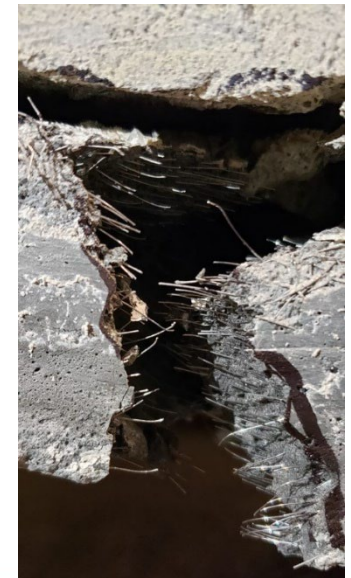
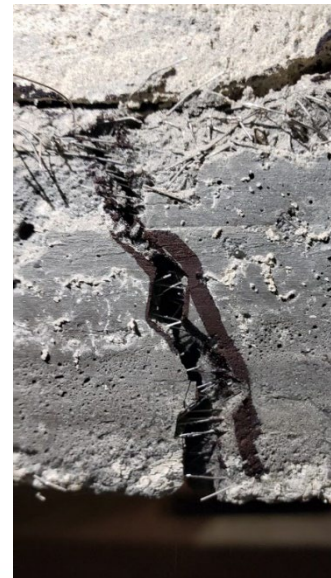
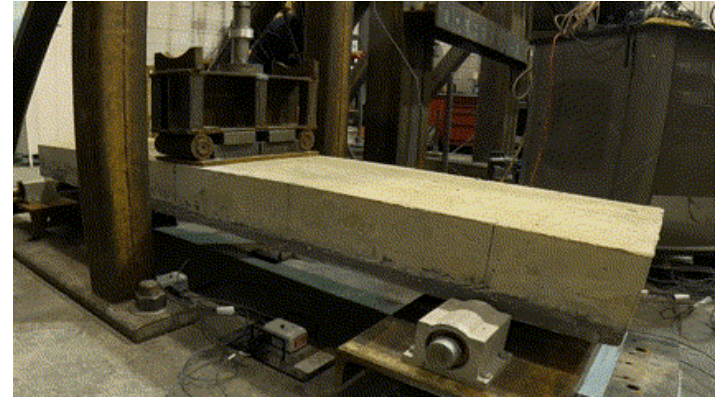
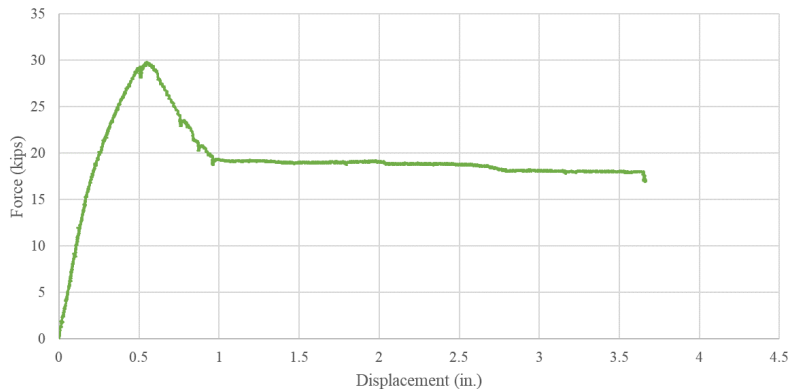

Discussion of Results

- Overall comparison and observed failure mechanisms
 - All specimens had similar initial stiffness
 - Control failed due to concrete crushing while the UHPC overlay specimens in positive moment failed in shear

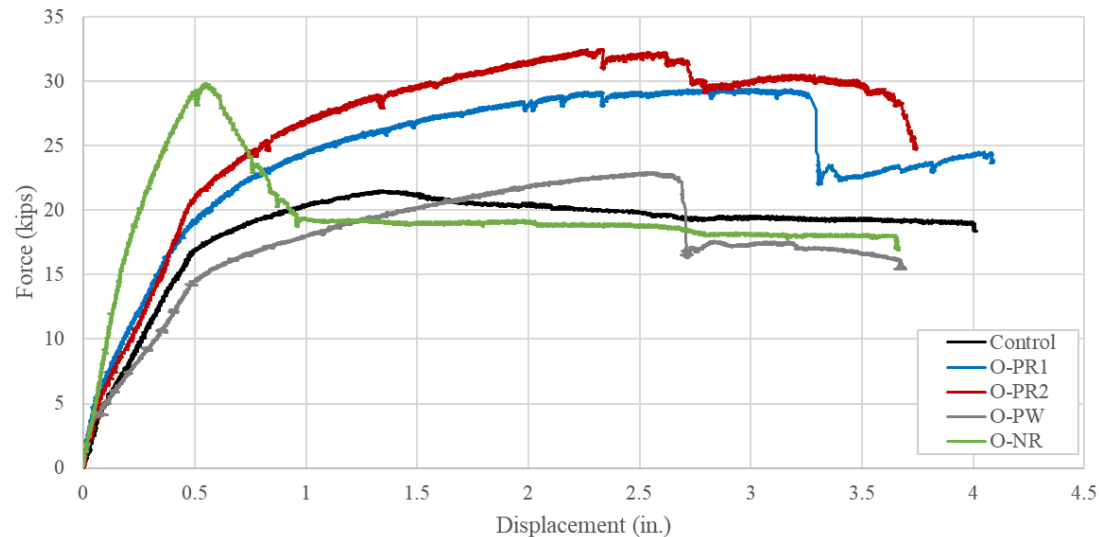

Effects of including UHPC overlays

- Overlay specimens are stiffer
- O-PR1 was 35% stronger than control while O-PR2 was 50% stronger
- Likely a result of total depth of each slab
 - Control – 6.28 in.
 - O-PR1 – 6.51 in.
 - O-PR2 – 6.64 in.

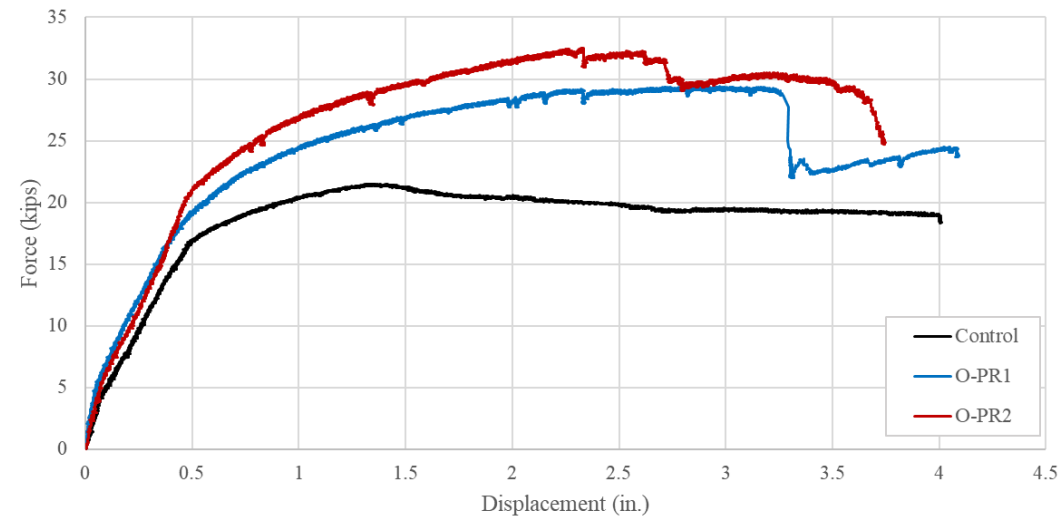

Effect of overlay thickness

- Deeper slab and thicker overlay had higher capacity as expected
- O-PR1
 - Total Depth = 6.51 in.
 - Overlay = 1.55 in.
- O-PR2
 - Total Depth = 6.64 in.
 - Overlay = 1.83 in.

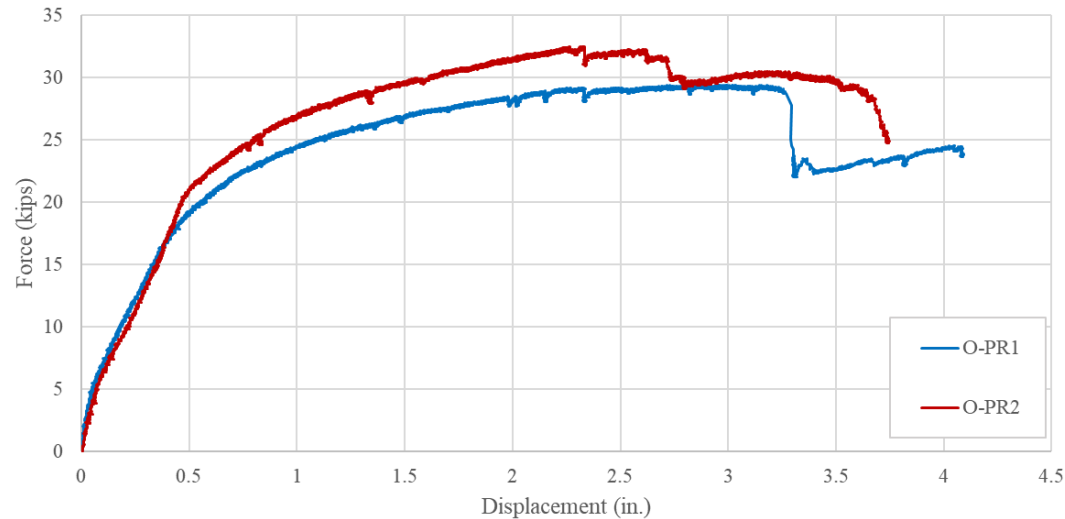

Effect of substrate concrete strength

- O-PR1 was stiffer and 28.2% stronger than O-PW as expected due to increased depth and stronger concrete
- Control and O-PW behaved similarly despite large differences in strength and overall depth
- Control
 - Total Depth = 6.28 in.
- O-PR1
 - Total Depth = 6.51 in.
 - Overlay = 1.55 in.
- O-PW
 - Total Depth = 5.73 in.
 - Overlay = 1.23 in.

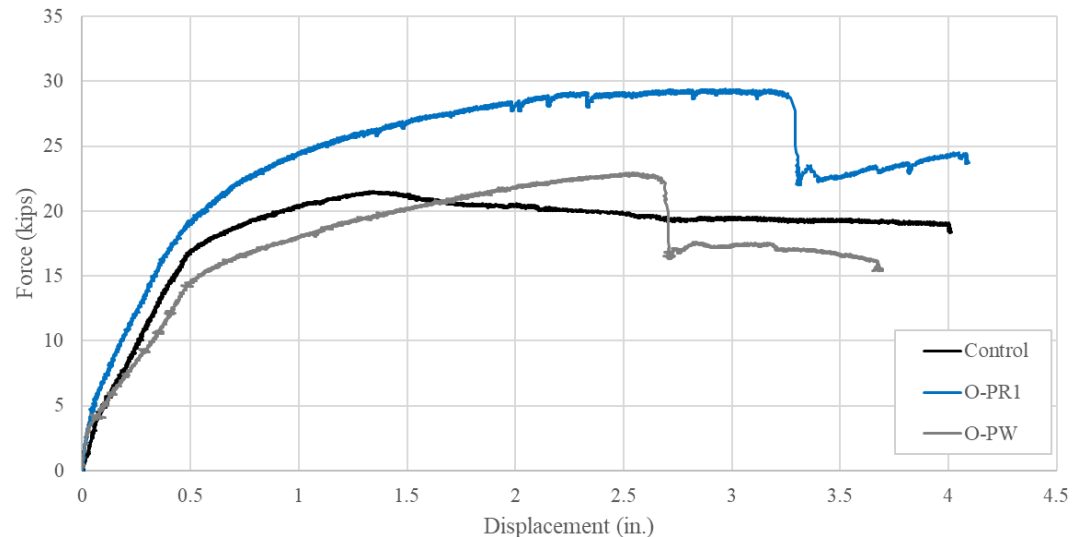

Negative vs. Positive Moment

- O-NR slab does not initially crack due to much higher tensile capacity of UHPC
- Highlights the benefits in stiffness and delaying the onset of initial surface cracking

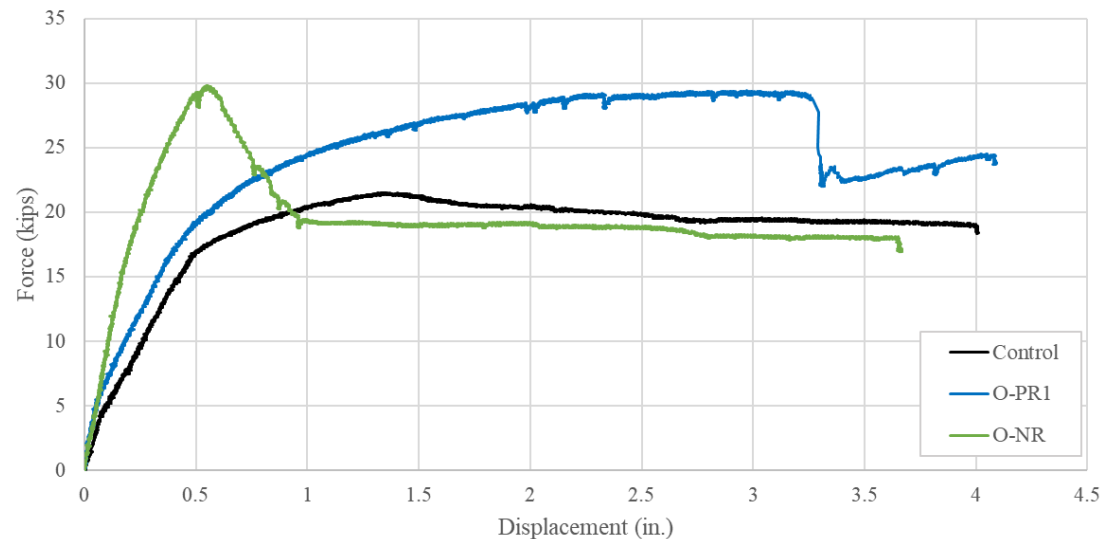

Measured vs. Predicted Capacities

Slab	Failure Mechanism	Measured Values			Moment Calculations		Shear Calculations	
		Measured P (kips)	Measured Moment (k-ft)	Measured Vc (kips)	Predicted Mn (k-ft)	Meas/Pred	Predicted Vc (kips)	Meas/Pred
Control	Concrete crushing	21.5	31.4	10.8	25.6	1.22	13.4	0.80
O-PR1	Shear in substrate	29.4	42.9	14.7	33.9	1.26	14.0	1.05
O-PR2	Shear in substrate	32.5	47.4	16.3	35.7	1.33	14.3	1.13
O-PW	Shear in substrate	22.9	33.4	11.5	28.4	1.18	11.9	0.96
O-NR	Cracking/ Concrete Crushing	29.8	43.5	14.9	45.4	0.96	13.0	1.15

Conclusions

- Replacing the top layer of the substrate concrete with a thin UHPC overlay increased the ultimate moment capacity.
- Slabs with a UHPC overlay typically experienced a shear failure at a high level of displacement and well after steel yielding, compared to a flexural failure in the control slab with concrete crushing at midspan.
- A weak deck strengthened with a thin UHPC overlay will respond similarly to a deck composed of much stronger normal concrete throughout.
- The negative moment capacity of a slab with a UHPC overlay is much higher compared to the control due to the higher tensile capacity of the UHPC. Additionally, the slab is much stiffer and initial surface cracking is delayed during negative bending.

Acknowledgements

- MDT for funding
- MDT Technical Panel
- James Starke, Emtiaz Ahmed, Ethan Turner, Jacques Ndengeyingoma, Cash Cota, Daniel Malyuta, Jake Artis, Hunter Tripple, and many others who assisted in construction

Thank You

