

MONTANA DEPARTMENT
OF TRANSPORTATION

Bridge Design Standards

Revised 10/7/2020

(Metric and English Units)

Bridge Design Standards and Guidelines

The following text and figures provide a summary of geometric design guidelines to assist the designer in preparing bridge plans. Consider the material as Standards for those projects with full Federal Oversight (those on the Interstate and NHS Systems) and as design guidelines for projects without full federal oversight. (STP, Secondary and Off-system projects)

Standards: Strict design policies that the designer must either follow or obtain a formal Design Exception to modify. The appropriate authority, usually the Road or Bridge Engineer, must grant and approve the Design Exception. The Design Exception request must include thorough justification of the reasoning for not meeting a standard. Right of Way availability and cost saving may form part of the discussion addressing design standards, but only as secondary issues. The primary focus must always remain the safety of the traveling public.

Guidelines: General rules that assist the designer to develop a project and to maintain similarity among projects, systems, and design teams. Guidelines provide flexibility within each design to allow incorporation of context-sensitive elements in the design. Document unusual design elements, including non-standard roadway geometry, bridge load capacity, or widths, and obtain agreement to their implementation in the Scope of Work Report. These variations from standards typically do not require formal Design Exceptions. The safety of the traveling public must take highest priority when considering approval of unusual or unique design features.

BRIDGE DESIGN STANDARDS

NATIONAL HIGHWAY SYSTEM (NHS) (INTERSTATE)

A) DESIGN STANDARDS

- 1) LIVE LOADING – HL 93 (LRFD Specifications)
HS 25 (MS 22.5) (AASHTO Standard Specifications)
- 2) DESIGN AND ANALYSIS PROCEDURES
Perform all structural designs with the current edition of the AASHTO LRFD Bridge Design Specifications or the AASHTO Standard Specifications for Highway Bridges and the Montana Department of Transportation Bridge Design Manual. If there is a difference between AASHTO and the Montana standards, the Montana standards control, because they tailor designs to local conditions.

B) HORIZONTAL AND VERTICAL CLEARANCES

See Attachment I-A

C) BRIDGE WIDTH See Bridge Design Memo dated 10/7/2020 for bridge width guidelines

~~1) NEW BRIDGES~~

~~New bridges on the interstate system will have a roadway width of 38.0 ft (11.4 m). This width breaks down as follows:~~

- ~~a) One 4.0 ft (1.2 m) inside shoulder~~
- ~~b) Two 12.0 ft (3.6 m) lanes, and~~
- ~~c) One 10.0 ft (3.0 m) outside shoulder.~~

~~See Attachment I-B for face to face of rail dimensions.~~

~~2) BRIDGES TO REMAIN IN PLACE~~

~~Consider bridges on the Interstate system with a roadway less than a 38.0 ft (11.4 m) for widening if they form part of a project already requiring major rehabilitation work to correct a deck problem or for a major seismic retrofit. Do not consider them for widening in projects consisting only of minor rehabilitation work.~~

~~Evaluate bridges requiring major rehabilitation work to determine if a cost/benefit analysis justifies widening them. Perform an engineering study for each bridge that considers sight distances, grades, roadway widths, bridge width, ADT, etc., prior to making the decision on whether to widen the bridge.~~

~~Where the project will not widen bridges, the Preconstruction Bureau will make recommendations about putting narrow bridge signs on bridges with a roadway width less than 38.0 ft (11.4 m).~~

D) SCOPE OF WORK (BRIDGES TO REMAIN IN PLACE)

Most of the work done on Interstate structures that remain in place will fall into one of three categories.

1) SAFETY WORK

Safety work will generally form part of a roadway resurfacing project, but can constitute a “stand alone” bridge project to correct a specific safety problem. Safety projects do not require widening bridges.

a) Bridge Rail

Modify bridge railing to comply with bridge rail policy (See Attachment I-G). Try to obtain a 31.0 ft (9.4 m) minimum roadway width for long bridges (over 200 ft (60 m)), if the cost/benefit analysis justifies doing so, when modifying rail to comply with policy.

b) Anti-skid treatment for decks.

2) MINOR REHABILITATION WORK

Minor rehabilitation work will generally consist of the items listed below and will usually form part of a roadway resurfacing project. It may include other items. Minor rehabilitation work does not require widening the bridge.

- a) Guard Angles
- b) Expansion joints
- c) Deck Seal (silane, HMWM, etc.)
- d) Spot painting of the structural steel
- e) Drains and Drainage systems
- f) Elevation adjustments
- g) Lighting upgrades

3) MAJOR REHABILITATION WORK

Usually the work under this category requires more plan development time than the corresponding roadway plans for a roadway resurface or overlay project. This work often requires a “stand alone” bridge project.

a) Deck Rehabilitation

i) Replacements

If it becomes necessary to replace a deck, evaluate the cost effectiveness of widening the structure to a roadway width of 38.0 ft (11.4 m). Give higher priority to bridges less than 200 ft (60 m) in length, as our limited resources will widen more bridges that way.

ii) Deck overlays

When deck conditions warrant and sufficient lead time exists time to obtain the deck survey a deck overlay can form part of a roadway overlay or a widen and overlay project. If sufficient lead time does not exist to match the road project, pursue the deck overlay as a “stand alone” project. Placing a deck overlay does not require widening the bridge.

b) Repainting or overcoat painting

c) Scour countermeasures

Give no consideration to widening a bridge where the project includes only scour counter-measures.

d) Structure condition ratings

Bring all structural elements to a condition rating of at least (7) as defined in Attachment I-C.

e) Miscellaneous

Any safety or minor rehabilitation work listed in D)1) or D)2) above may also form part of a major rehabilitation project.

4) SEISMIC RETROFITTING

The Seismic Crew has screened all bridges for seismic requirements in accordance with the Bridge Bureau Seismic Screening procedure. (See Attachment 1-D). Base retrofit needs on their ratings.

NATIONAL HIGHWAY SYSTEM (NHS)
(NON - INTERSTATE)

A) DESIGN STANDARDS

- 1) LIVE LOADING – HL 93, HS 25 or MS 22.5 for new construction
HS 15 or MS 13.5 for bridges to remain in place
- 2) DESIGN AND ANALYSIS PROCEDURES
Perform all structural designs in accordance with the current edition of the AASHTO LRFD Bridge Design Specification or of the AASHTO Standard Specifications for Highway Bridges and the Montana Department of Transportation Bridge Design Manual. If there is a difference between AASHTO and the Montana standards, the Montana standards control, because they tailor designs to local conditions.

B) HORIZONTAL AND VERTICAL CLEARANCES

See Attachment I-A

C) BRIDGE WIDTH

See Bridge Design Memo dated 10/7/2020 for bridge width guidelines

~~1) NEW BRIDGES~~

~~New bridges on the NHS system (non interstate) will have a roadway width in accordance with the table below, but the roadway width must also at least equal that shown on the NHS Route Segment Map. (See Attachment I B for face to face of rail dimensions.)~~

~~FROM TABLE VII-2 P 499 1990 AASHTO GREEN BOOK FOR 50, 60 and 70 mph (80,100, and 110 kph) DESIGNS~~

Minimum Roadway Widths for New Bridges		
Projected Traffic	Bridge Roadway Width	
	English	Metric
ADT < 400	32.0 ft (60 & 70 mph)	9.6 m (100 & 110 kph)
ADT ≥ 400	36.0 ft	10.8 m
DHV* 100-200	36.0 ft	10.8 m
DHV > 200	40.0 ft	12.0 m

~~* Design Hourly Volume~~

~~FROM THE ROUTE SEGMENT MAP~~

Minimum Roadway Widths		
Road	English	Metric
Green Road	32.0 ft	9.6 m
Blue Road	36.0 ft	10.8 m
Red Road	40.0 ft	12.0 m

~~2) BRIDGES TO REMAIN IN PLACE~~

~~Bridges on the Non Interstate NHS must have a roadway width of at least 28.0 ft (8.4 m) to qualify for consideration to remain in place. If a bridge within the limits of a project is functionally and structurally adequate and has a roadway width less than 28.0 ft (8.4 m) the project must widen it to meet the requirements of section C)1) above.~~

~~The Preconstruction Bureau will make recommendations about putting up narrow bridge signs when the bridge width is less than the roadway width.~~

D) SCOPE OF WORK (BRIDGES TO REMAIN IN PLACE)

Most of the work required on bridges that remain in place will fall into one of three categories.

1) SAFETY WORK

Safety work will generally form part of a roadway overlay or overlay and widen project, but can constitute a “stand alone” bridge project to correct a specific safety problem. If the bridge lies within the limits of a roadway overlay or overlay and widen project, the bridge’s final roadway width must comply with Section C) 2) above.

- a) Bridge Rail
Modify bridge railing to comply with bridge rail policy. (See Attachment I-G).
- b) Anti-skid treatment for decks.

2) MINOR REHABILITATION WORK

Minor rehabilitation work will generally consist of the items listed below and will usually form part of a roadway overlay or overlay and widen project. It may include other items. Widen the bridge if its roadway width does not meet the requirements of section C) 2).

- a) Guard Angles
- b) Expansion joints
- c) Deck seal (silane, HMWM, etc.)
- d) Spot painting of structural steel
- e) Drains and Drainage systems
- f) Elevation adjustments
- g) Lighting upgrades

3) MAJOR REHABILITATION WORK

Usually the work under this category requires more plan development time than the corresponding roadway plans for an overlay or overlay and widen project. This work often requires a “stand alone” bridge project.

a) Deck Rehabilitation

- i) Replacements
If it becomes necessary to replace a deck, perform a cost benefit analysis to determine whether to widen the bridge to the width indicated in section C) 1).
- ii) Deck overlays
When deck conditions warrant and sufficient lead time exists to obtain the deck survey and prepare plans, a deck overlay can form part of a roadway overlay or overlay and widen project. If the road project schedule does not allow time to perform deck testing, execute the deck overlay as a “stand alone” project. If the bridge meets the minimum roadway width requirement of 28.0 ft (8.4 m) widening the deck is not a required part of the overlay.

b) Repainting or overcoat painting

- c) Scour counter-measures
Give no consideration to widening a bridge where the project includes only scour counter-measures.

d) Structure condition ratings

Bring all structural elements back to a condition rating of at least (7), as defined in Attachment I-C.

e) Miscellaneous

The project may include any safety or minor rehabilitation work listed in section D) 1) or D) 2).

4) SEISMIC RETROFITTING

The Seismic Crew has screened all bridges for seismic requirements in accordance with the Bridge Bureau Seismic Screening procedure. (See Attachment 1-D). Base retrofit needs on their ratings.

SURFACE TRANSPORTATION PROGRAM (STP)
(NON-NHS PRIMARY)

A) DESIGN STANDARDS

- 1) LIVE LOADING – HL 93, HS 25 or MS 22.5 for new construction
-- HS 15 or MS 13.5 for bridges to remain in place

2) DESIGN AND ANALYSIS PROCEDURES

All structural designs will be done in accordance with the current edition of the AASHTO LRFD Bridge Design Specification or of the AASHTO Standard Specifications for Highway Bridges and the Montana Department of Transportation Bridge Design Manual. In the case of a difference between AASHTO and the Montana standards, the Montana standards control, because they tailor designs to local conditions.

B) HORIZONTAL AND VERTICAL CLEARANCES

See Attachment I-A

C) BRIDGE WIDTH

See Bridge Design Memo dated 10/7/2020 for bridge width guidelines

~~1) NEW BRIDGES~~

~~New bridges on the STP system (NON-NHS PRIMARY) will have a roadway width in accordance with the table below, but the roadway width must also at least equal that shown on the STP Route Segment Map. (See Attachment I-B for face to face of rail dimensions)~~

~~FROM TABLE VII-2 P 499 1990 AASHTO GREEN BOOK FOR 45, 55 and 60 mph (70, 90, AND 100 kph) DESIGNS~~

Minimum Roadway Widths for New Bridges		
Projected Traffic	Bridge Roadway Width	
	English	Metric
ADT < 400	30.0 ft (45 mph)	9.0 m (70 kph)
	32.0 ft (55 & 60 mph)	9.6 m (90 & 100 kph)
ADT ≥ 400	36.0 ft	10.8 m
DHV* 100-200	36.0 ft	10.8 m
DHV > 200	40.0 ft	12.0 m

~~* Design Hourly Volume~~

~~FROM THE ROUTE SEGMENT MAP~~

Minimum Roadway Widths		
Road	English	Metric
Black Road	Maintain Existing Level of Service	Maintain Existing Level of Service
Yellow Road	28.0 ft	8.4 m
Green Road	32.0 ft	9.6 m
Red Road	40.0 ft	12.0 m

~~2) BRIDGES TO REMAIN IN PLACE~~

~~The table below shows the minimum roadway width of bridge for consideration to remain in place at the present width on the STP (NON-NHS PRIMARY).~~

~~If a bridge within the limits of a project is functionally and structurally adequate to remain in place but has less roadway width than indicated in the table below widen it to the roadway width shown in C) 1).~~

~~The Preconstruction Bureau will make recommendations about putting narrow bridge signs up when the bridge width is less than the roadway width.~~

Minimum Bridge Roadway Width		
Route	English	Metric
Black Route	24.0 ft	7.2 m
Yellow Route	24.0 ft	7.2 m
Green Route	28.0 ft	8.4 m
Red Route	28.0 ft	8.4 m

D) SCOPE OF WORK (BRIDGES TO REMAIN IN PLACE)

Most of the work required on bridges that are to remain in place will fall into one of three categories shown below.

1) SAFETY WORK

Safety work will generally form part of a roadway overlay or overlay and widen project, but can constitute a “stand alone” bridge project to correct a specific safety problem. If the bridge lies within the limits of a roadway overlay or overlay and widen project the bridge’s final roadway width must comply with the minimum roadway widths listed in paragraph C) 2) above.

a) Bridge Rail

Modify bridge railing to comply with the bridge rail policy. (See Attachment I-G).

b) Anti-skid treatment for decks

2) MINOR REHABILITATION WORK

Minor rehabilitation work will generally consist of the items listed below and will usually form part of an overlay or overlay and widen project. It may include other items. Widen the bridge if its roadway width does not meet the requirements in paragraph C) 2) above.

- a) Guard Angles
- b) Expansion joints
- c) Deck seal (silane, HMWM, etc.)
- d) Spot painting of structural steel
- e) Drains and Drainage systems
- f) Elevation adjustments
- g) Lighting upgrades

3) MAJOR REHABILITATION WORK

Usually the work under this category requires more plan development time than the corresponding roadway plans for a roadway overlay or overlay and widen project. This work often requires a “stand alone” bridge project.

a) Deck Rehabilitation

i) Replacements

If it becomes necessary to replace a deck, perform a cost benefit analysis to determine whether to widen the bridge to the roadway width indicated in section C) 1).

ii) Deck overlays

When deck conditions warrant and if there is sufficient lead time to obtain the deck survey and prepare plans, a deck overlay can form part of a roadway overlay or overlay and widen project. If the road project schedule does not allow time to perform deck testing, execute the deck overlay as a “stand alone” project. As long as the bridge meets the minimum roadway width requirement shown in section C) 2) the overlay can proceed without widening the bridge.

- b) Repainting of overcoat painting
 - c) Scour countermeasures
Give no consideration to widening a bridge when the project contains only scour counter-measures.
 - d) Structure condition ratings
Bring all structural elements back to a condition rating of at least (7), as defined in Attachment I-C.
 - e) Miscellaneous
The project may include any safety or minor rehabilitation work listed in sections D) 1) or D) 2) as part of a major rehabilitation project.
- 4) SEISMIC RETROFITTING
The Seismic Crew has screened all bridges for seismic requirements in accordance with the Bridge Bureau Seismic Screening procedure. (See Attachment 1-D). Base retrofit needs on their ratings.

SURFACE TRANSPORTATION PROGRAM (STP)
(SECONDARY & OFF SYSTEM)

A) DESIGN STANDARDS

- 1) LIVE LOADING – HL 93, HS 25 or MS 22.5 for new construction
– MS 13.5 for bridges to remain in place.

2) DESIGN AND ANALYSIS PROCEDURES

All structural designs will be done in accordance with the current edition of the AASHTO LRFD Bridge Design Specifications or of the AASHTO Standard Specifications for Highway Bridges and the Montana Department of Transportation Bridge Design Manual. In the case of a difference between AASHTO and the Montana standards, the Montana standards control, because they tailor designs to local conditions.

B) HORIZONTAL AND VERTICAL CLEARANCES

See Attachment I-A

C) BRIDGE WIDTH

See Bridge Design Memo dated 10/7/2020 for bridge width guidelines

~~1) NEW BRIDGES~~

~~a) Secondary System~~

~~New bridges on the STP system (SECONDARY) will have a roadway width in accordance with the table below, but not less than the MDT roadway standard for the Secondary System. (See Attachment I-B for face to face of rail dimensions).~~

~~FROM TABLE VI 5 P 475 1990 AASHTO GREEN BOOK FOR 45, 55 and 60 mph (70, 90, AND 100 kph) DESIGNS~~

Secondary and Local System Bridge Roadway Widths		
Current Traffic	Bridge Roadway Width	
	English	Metric
ADT < 400	28.0 ft	8.4 m
ADT ≥ 400	30.0 ft	9.0 m
DHV* 100-200	30.0 ft	9.0 m
DHV 200-400	32.0 ft	9.6 m
DHV > 400	40.0 ft	12.0 m

~~* Design Hourly Volume~~

~~b) Off System~~

~~Use a minimum roadway width of 28.0 ft (8.4 m) for off-system bridges unless the county has a different standard or if the road has very low volume and a single lane bridge would be adequate. If the county does have a higher standard the bridge width, match the county standard.~~

~~Consider using single lane bridges for very low volume roads. The minimum roadway width of a single lane bridge is 16.0 ft (4.8 m). This width breaks down as follows:~~

- ~~a) One 2.0 ft (0.6 m) inside shoulder~~
- ~~b) One 12.0 ft (3.6 m) lane, and~~
- ~~c) One 2.0 ft (0.6 m) shoulder.~~

~~When considering bridge roadway widths less than 28.0 ft (8.4 m) or less than the county standard, obtain the District's and the county's concurrence.~~

~~2) BRIDGES TO REMAIN IN PLACE~~

~~For consideration to remain in place bridges must have a minimum roadway width of 24.0 ft (7.2 m).~~

~~If a bridge within the limits of a project is otherwise functionally and structurally adequate to remain, widen it to the width shown in section C) 1).~~

~~Truss bridges on off system (county) routes that can be rehabilitated to the criteria of section D) 3) e) may for remain in place.~~

~~The Preconstruction Bureau will make recommendations about putting narrow bridge signs up whenever the bridge width is less than the roadway width.~~

D) SCOPE OF WORK (BRIDGES TO REMAIN IN PLACE)

Most of the work on bridges that remain in place will fall into one of three categories.

1) SAFETY WORK

Safety work will generally form part of a roadway overlay or overlay and widen project but can constitute a "stand alone" bridge project to correct a specific safety problem. If the bridge lies within the limits of a roadway overlay or overlay and widen project it must comply with the minimum roadway width of 24.0 ft (7.2 m) stated in C) 2) above.

a) Bridge Rail

Modify all bridge railing to comply with bridge rail policy. (See Attachment I-G).

b) Anti-skid treatment for decks

2) MINOR REHABILITATION WORK

Minor rehabilitation work will generally consist of the items listed below and will usually form part of a roadway overlay or overlay and widen project. Minor rehabilitation work may include other items. Widen the bridge if its roadway does not meet the minimum width of 24.0 ft (7.2 m) stated in C) 2) above.

a) Guard Angles

b) Expansion joints

c) Deck seal (silane, HMWM, etc.)

d) Spot painting of structural steel

e) Drains and Drainage systems

f) Elevation adjustments

g) Lighting upgrades

3) MAJOR REHABILITATION WORK

Usually the work under this category requires more plan development time than the corresponding roadway plans for a roadway overlay or overlay and widen project. This work often requires a "stand alone" bridge project.

a) Deck Rehabilitation

i) Replacements

If it becomes necessary to replace a deck, perform a cost benefit analysis to determine whether to widen the bridge to the roadway width indicated in C) 1) above.

ii) Deck overlays

If the road project allows sufficient time to obtain a deck survey and to prepare plans, a deck overlay can form part of a roadway overlay or overlay and widen project. As long as the bridge meets the minimum roadway width requirement of 28.0 ft (8.4 m) the project may overlay the bridge without widening it.

b) Repainting or overcoat painting

- c) Scour counter-measures
Give no consideration to widening a bridge when the project consists only of scour counter-measures.
- d) Structure condition ratings
Bring all structural elements back to a condition rating of at least (7), as defined in Attachment I-C.
- e) Miscellaneous
The project may include safety or minor rehabilitation work listed in D) 1) or D) 2) above as a part of a major rehabilitation project.
- f) Truss Rehabilitation
 - i) Width
Do not rehabilitate a truss that does not provide a roadway width of at least 16.0 ft (4.90 m).
 - ii) Widening a truss is seldom cost effective because it requires replacement of all floor beams and bracing. Do not consider widening a truss without specific approval from the Bridge Engineer.
 - iii) Load Capacity
Do not rehabilitate a truss that cannot provide capacity for at least HS 15 or MS 13.5 loading when the work is complete. Perform a cost benefit analysis to determine whether to pursue MS 18 loading, MS 13.5, or whether to accept some intermediate value.
 - iv) Vertical Clearance
Do not rehabilitate a truss that cannot provide at least 14.0 ft (4.3 m) vertical clearance.
 - v) Historical Significance
Historically significant structures require special consideration when determining whether to rehabilitate them.

ATTACHMENT I-A
STANDARD HORIZONTAL AND VERTICAL CLEARANCES
FOR SEPARATION STRUCTURES

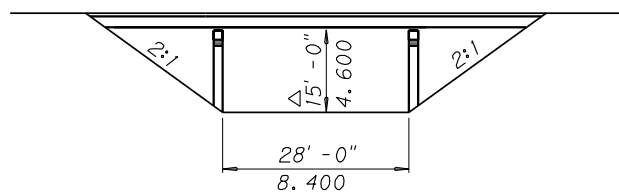
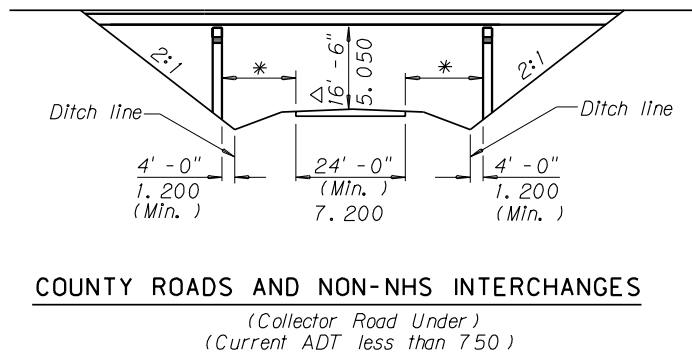
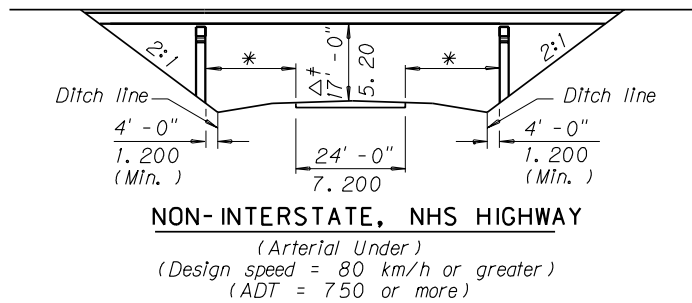
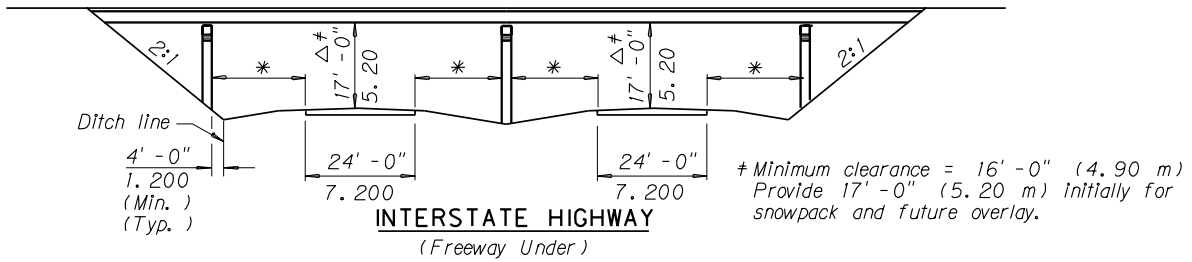

* Follow the standard drawings in placing guardrail where conditions do not allow providing the clear zone distances defined in the Montana Road Design Manual.

△ These values provide room for up to 6 inches (150 mm) of additional surfacing without revising grades

NOTE: See attachment I-F for railroad clearances.

NOTE: Measure vertical clearance to low point between roadway shoulders on exterior beams.

ATTACHMENT I-B

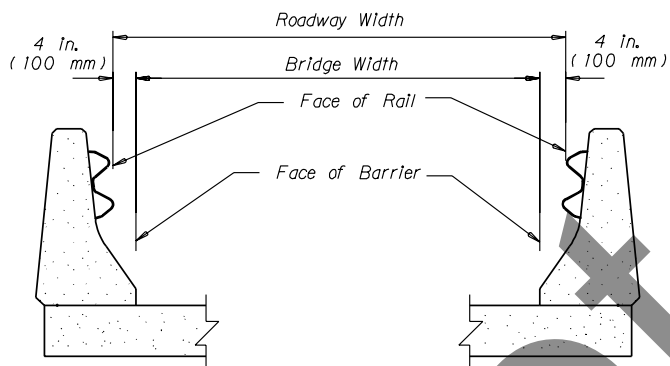
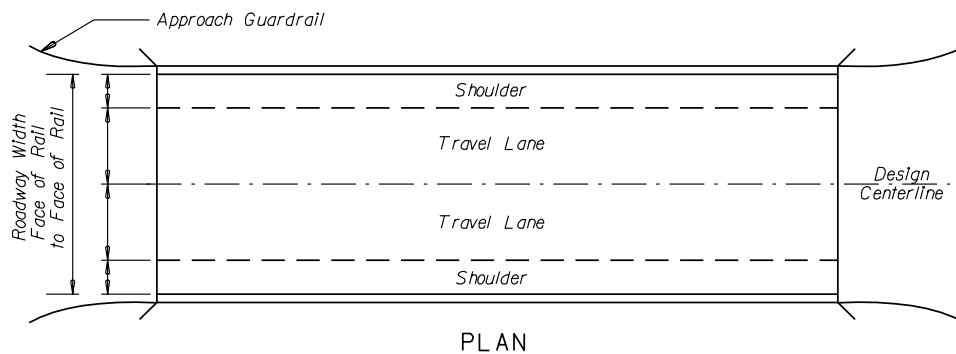

See Bridge Design Memo dated 10/7/2020 for bridge width drawings

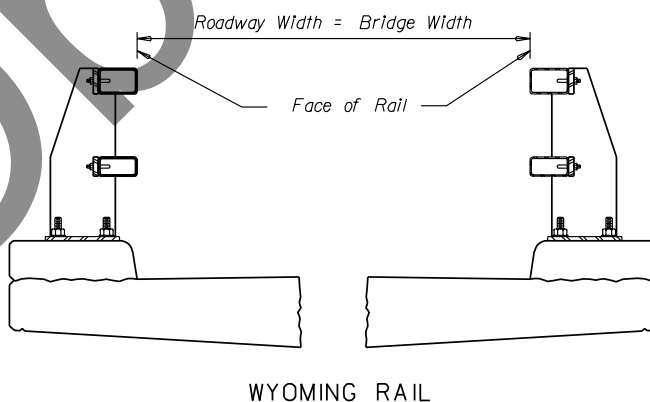
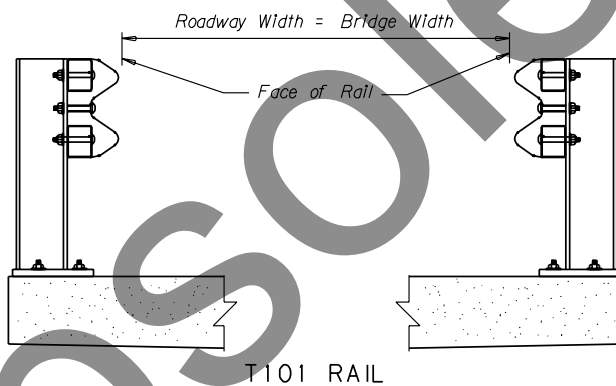

ATTACHMENT I-C

STRUCTURE CONDITION RATINGS

The below structure condition rating descriptions are those used by our bridge inspectors. The ratings for the structural elements can be found in the inspection file for the structure in question.

- (9) Excellent Condition
- (8) Very Good Condition
No problems noted
- (7) Good Condition
Some minor problems
- (6) Satisfactory Condition
Structural elements show some minor deterioration.
- (5) Fair Condition
All primary structural elements are sound but may have minor section loss, cracking, spalling or scour.
- (4) Poor Condition
Advanced section loss, deterioration, spalling or scour
- (3) Serious Condition
Loss of section, deterioration, spalling or scour have seriously affected primary structural components. Local failures are possible. Fatigue cracks in steel or shear cracks in concrete may be present.
- (2) Critical Condition
Advanced deterioration of primary structural elements. Fatigue cracks in steel or shear cracks in concrete may be present or scour may have removed substructure support. Unless closely monitored it may be necessary to close the bridge until corrective action is taken.
- (1) Imminent Failure Condition
Major deterioration or section loss is present in critical structural components or obvious vertical or horizontal movement affecting structural stability. Bridge is closed to traffic but corrective action may put it back in light service.
- (0) Failed Condition
Out of service and beyond corrective action.

ATTACHMENT I-D

PRELIMINARY SCREENING OF BRIDGES FOR SEISMIC RETROFITTING

GENERAL:

An efficient and comprehensive retrofitting program requires that structures be rated according to their need for seismic retrofitting by a preliminary screening process.

The Seismic Rating System, described below, shall be used as a basis for selecting bridges for the more detailed quantitative evaluation.

SEISMIC RATING SYSTEM

Bridges in Seismic Performance Category – A (SPC-A) will be eliminated from review, because they generally do not require retrofitting.

To calculate the seismic rating of a bridge, consideration is given to structural vulnerability, seismicity of the bridge site, and the bridge's importance as a vital transportation link. This is accomplished by making independent ratings of the bridges in each of these three areas. The ratings are added to arrive at an overall seismic rating according to the following procedure:

Seismic Rating = 1.11 (superstructure + substructure + $\frac{1}{2}$ liquefaction + $\frac{1}{2}$ abutment) + 51.6 (seismicity) + 8.03 (importance)

The constants in this equation were derived to give equal weight to the three areas. The total Seismic Rating will typically have a value ranging from 7 to 100.

STRUCTURE VULNERABILITY RATING

The structure vulnerability rating is based on superstructure, substructure, liquefaction and abutment vulnerability ratings. Superstructure and substructure vulnerabilities are based on susceptible structural details. These can be evaluated more accurately than liquefaction and abutment vulnerabilities. The superstructure and substructure vulnerabilities will more likely cause catastrophic failures, whereas abutment vulnerabilities will cause serviceability failures. Therefore, superstructure and substructure vulnerability ratings have been weighted higher in the overall structure vulnerability rating.

Structure Vulnerability Rating = [Super + Sub + $\frac{1}{2}$ (liquefaction) + $\frac{1}{2}$ (abutment)]

Superstructure Vulnerability Rating

The superstructure vulnerability rating is based on the connections to the substructure which are mainly the bearing details. The Superstructure Vulnerability Rating is based on the "FHWA Seismic Retrofitting Guidelines for Highway Bridges".

The step-by-step method for determining the vulnerability rating of the superstructure follows:

Step 1: Determine if the bridge has non-vulnerable bearing details. These bridges would include:

- a) Continuous structures with integral abutments.
- b) Continuous structures with seat-type abutments where all of the following conditions are met:

- i) The skew is less than 20°, or the skew is greater than 20° but less than 40° and the length-to-width ratio of the bridge deck is less than 1.5.
- ii) Rocker bearings are not used.
- iii) The bearing seat on the abutment end diaphragm is continuous in the transverse direction and the bridge has in excess of three girders.
- iv) The support length is equal to or greater than one half the minimum required support length.

If the bearing details are non-vulnerable, a vulnerability rating of 0 may be assigned and the remaining steps for bearings omitted.

Step 2: Determine the vulnerability to structure collapse or loss of bridge access due to transverse movement.

Before significant transverse movement can occur, the transverse restraint must fail. Nominal bearing keeper bars or anchor bolts should be considered subject to failure for bridges in SPC-C and D. Nominally reinforced, non-ductile concrete shear keys should be considered subject to failure for bridges in SPC-D only.

When transverse restraint is subject to failure, girders are vulnerable to collapse if either of the following conditions exists:

- a) Individual girders are supported on individual pedestals or columns.
- b) The exterior girder in a 2- or 3- girder bridge is less than 18 inches from the edge of a continuous-bearing support.

In either of these cases, the vulnerability rating should be 10.

Step 3: Determine the vulnerability of the structure to collapse or loss of accessibility due to excessive longitudinal movement. Steel rocker bearings have been known to topple, resulting in a partial superstructure displacement. All bridges assigned to SPC-C or D are vulnerable to this type of failure.

If the longitudinal support length capacity/demand is greater than one, the vulnerability rating shall be assigned a value of 0 unless in addition rocker bearings are vulnerable to toppling, in which case a value of 5 should be assigned.

If the longitudinal support length capacity/demand is less than one, but greater than 0.5, the vulnerability rating shall be assigned a value of 5 unless in addition rocker bearings are vulnerable to toppling, in which case a value of 10 should be used. If the longitudinal support length capacity/demand is less than 0.5, then a vulnerability rating of 10 should be assigned.

The required longitudinal support length will be calculated using AASHTO 4.9.1 (Division I-A). The support length shall be measured normal to the face of an abutment or pier.

For SPC B

$$N = 8 + 0.02L + 0.08H \text{ (in.)}$$

For SPC C & D

$$N = 12 + 0.03L + 0.12H \text{ (in.)}$$

Where:

N = Required longitudinal support length in inches measured perpendicular to the face of the support.

L = length, in feet, of the bridge deck to the adjacent expansion joint, or to end of the bridge deck. For hinges within a span, L shall be the sum of L_1 and L_2 (the distances to either side of the hinge). For single span bridges L equals the length of the bridge deck.

For abutments

H = average height, in feet, of columns supporting the bridge deck to the next expansion joint. H = 0 for single span bridges.

For columns and/or piers

H = column or pier height in feet.

For hinges within a span

H = average height of the adjacent two columns or piers in feet.

Substructure Vulnerability Rating

The substructure vulnerability rating is based on a method used by WSDOT.

Where:

$$VR_{sub} = (V_{splice} + V_{conf} + V_{anch}) (Fr)$$

$$V_{splice} = 3.5 \text{ or } 0.0$$

$$V_{conf} = 3.5 \text{ or } 0.0$$

$$V_{anch} = 3.0 \text{ or } 0.0$$

$$Fr = \begin{aligned} &= 1.0 \text{ for single column} \\ &= 0.9 \text{ for double column} \\ &= 0.8 \text{ for all others including piers} \end{aligned}$$

For Seismic Performance Category B, C & D

If $C/D > 1.0$ then V_{splice} , V_{conf} and $V_{anch} = 0.0$

Where:

C = Capacity of splice length, splice location, confinement provided by lateral reinforcement, and anchorage of longitudinal bars as determined from As-built plans.

D = Demand as required by AASHTO specifications for splice length, splice location, confinement, and anchorage.

Seismic Performance Category B

- Vsplice: -Need to consider only the length of lap splice.
-No AASHTO Seismic Specification; need to satisfy AASHTO 8.32 (Division I)
- Vconf: -Per AASHTO Seismic Specification 8.4.1(c, d, e) except maximum spacing is six inches.
- Vanch: -No AASHTO Seismic Specification; need to satisfy AASHTO 8.25 through 8.30 (Division I)

Seismic Performance Categories C and D

- Vsplice: -AASHTO sections 8.33 (Division I) and Seismic Specifications 8.41(f) (Division I-A).
- Vconf: -AASHTO seismic specifications 8.4.1 (c, d, e)
- Vanch -AASHTO Seismic Specifications 8.4.3.

ABUTMENT VULNERABILITY DETERMINATION

Abutment vulnerability is based on the FHWA "Seismic Retrofitting Guidelines for Highway Bridges". Abutment failures during earthquakes do not usually result in total collapse of the bridge. This is especially true for earthquakes of low-to-moderate intensity. Except in unusual cases, the maximum abutment vulnerability rating will be 5.

SCREENING

Step 1:

If bridge is in SPC-B, $V_R=0$

Step 2:

Determine the vulnerability of the structure due to abutment fill settlement in SPC-C and D. The fill settlement can be estimated as follows:

1% of the fill height when $0.19 < A \leq 0.29$

2% of the fill height when $0.29 < A \leq 0.39$

3% of the fill height when $A > 0.39$

The above settlements should be doubled if the bridge is a water crossing. When fill settlements are estimated to be greater than six inches, $V_R = 5$. If less than six inches, $V_R = 0$.

The above settlements should be increased additionally up to twice their new value (adjusted for water crossing) if the bridge inspection reports show problems with settlement or degradation of abutment foundation.

Step 3:

For bridges classified as SPC-D, free standing earth-retaining abutments, with skews greater than 40° and the distance between the seat and the bottom of the footing exceeds ten feet, a vulnerability rating of five should be assigned.

LIQUEFACTION VULNERABILITY DETERMINATION

Bridges with continuous superstructures and supports can withstand large translational deformations and usually remain serviceable. Bridges with discontinuous superstructures and/or brittle supporting members are usually severely damaged as a result of liquefaction. It must be kept in mind that the effect of liquefaction on spread footings is different than its effect on pile footings.

The depth of the water table may need to be assumed. This judgment should be based on bridge location, crossing, and general knowledge of the area.

SCREENING

Step 1:

Determine the susceptibility of foundation soils to liquefaction. Soils above the water table are not susceptible to liquefaction.

- a) High susceptibility is associated with loose, fine, non-cohesive soils (sands, silty sands, and non-plastic silts).
- b) Moderate susceptibility is associated with similar soils described as medium dense.
- c) Low susceptibility is associated with dense soils. Clayey soils and gravels also fall into this category. Soils with large diameter particles (gravels) are unlikely to liquefy unless an overlying layer of low permeability soils inhibits drainage.

Step 2:

Determine the potential extent of liquefaction related damage where susceptible soil conditions exist:

- a) Severe liquefaction related damage is likely to occur for conditions of high susceptibility when $A > 0.29$.
- b) Major liquefaction related damage is likely to occur for conditions of high susceptibility when $0.19 < A \leq 0.29$, or for conditions of moderate susceptibility when $A > 0.29$.
- c) Moderate liquefaction related damage is likely to occur for conditions of high susceptibility for $0.09 < A \leq 0.19$, and for conditions of moderate susceptibility where $0.19 < A \leq 0.29$.
- d) Low liquefaction related damage is likely to occur for conditions of moderate susceptibility when $0.09 < A \leq 0.19$, and for all conditions of low susceptibility.

Step 3:

Bridges subjected to severe liquefaction related damage shall be assigned a $V_R = 10$. This rating may be reduced to 5 for single-span bridges with skews less than 20° .

Step 4:

Bridges subjected to major liquefaction related damage shall be assigned a $V_R = 10$. This may be reduced to 5 for single span bridges with skews less than 40° .

Step 5:

Bridges subjected to moderate liquefaction related damage should have a $V_R = 5$.

Step 6:

Bridges subjected to low liquefaction related damage should have a $V_R = 0$.

Seismicity Rating

$$\text{Seismicity Rating} = S \cdot A$$

The site coefficient (S) approximates the effects of the site conditions on the elastic response coefficient or spectrum.

Site Coefficient (S)			
Soil Profile Type			
	I	II	III
S	1.0	1.2	1.5

SOIL PROFILE TYPE I is a profile with either:

- 1) Rock of any characteristic, either shale-like or crystalline in nature (such material may be characterized by a shear wave velocity greater than 2,500 ft/sec (762 m/sec), or by other appropriate means of classification); or
- 2) Stiff soil conditions where the soil depth is less than 200 ft (61 m) and the soil types overlying rock are stable deposits of sands, gravels, or stiff clays.

SOIL PROFILE TYPE II is a profile with stiff clay or deep cohesionless conditions where the soil depth exceeds 200 ft (61 m) and the soil types overlying rock are stable deposits of sands, gravels, or stiff clays.

SOIL PROFILE TYPE III is a profile with soft to medium-stiff clays and sands, characterized by 30 ft (9 m) or more of soft to medium-stiff clays with or without intervening layers of sand or other cohesionless soils.

In locations where the soil properties are not known in sufficient detail to determine the soil profile type or where the profile does not fit any of the three types, the site coefficient for Soil Profile Type II shall be used. The soil profile coefficients apply to all foundation types including pile supported and spread footings.

A = The seismic acceleration coefficient based on the Map of Horizontal Acceleration.

IMPORTANCE RATING

The mathematical model developed below is an index by which MDT will prioritize the importance of a bridge for seismic retrofitting. This model follows the basic criteria established by WSDOT, and uses information from the NBIS database.

The form of the model is:

$$I = \frac{2}{3} [(RT_{carry}) (DL_{carry}) (N_{carry})] + \frac{1}{4} [(ADT_{carry}/6000)(L)]^{0.25} + RV_{cross}$$

In which:

RT_{carry} = Factor representing type of route carried by the bridge.

We will use the functional classification (item 26) from the NBIS database.

Codes of 01, 11, 12, & 14 will have a value = 1.0, all other codes will have a value = 0.8

DL_{carry} = Factor representing detour length of route carried by bridge

1.2 when detour is > 98 miles
1.0 when detour is ≥ 50 and ≤ 98 miles
0.9 when detour is ≥ 10 and < 50 miles or *Interstate 1 mile
0.8 when detour is ≥ 3 miles and < 10 miles
0.7 when detour is < 3 miles

*Note: Twin structures on the Interstate are coded with a one mile detour. This assumes that one structure will be the detour bridge. We will assume both structures are not useable and assign it a default value of 0.9 for preliminary screening.

N_{carry} = Factor representing criticality of detour for the route carried due to traffic congestion.

$$N_{carry} = [ADT_{carry}/6000]^{0.25}$$

ADT_{carry} = Average Daily Traffic of the route carried by the bridge.

RT_{cross} = Factor representing type of route crossed by the bridge.

We will use the functional classification (item 26) and the type of service under (item 42) from the NBIS database.

If item 26 is coded a 01, 11, 12, or 14 then RT_{cross} = 1.0, all other codes will yield a value = 0.8; if item 42 under is coded a 2, 4, 7, or 8 (railroad) the value will also be 1.0.

DL_{cross} = Factor representing detour length of route crossed by bridge

1.2 when detour is > 98 miles
1.0 when detour is ≥ 50 and ≤ 98 miles
0.9 when detour is ≥ 10 and < 50 miles or *Interstate 1 mile
0.8 when detour is 3 miles to 10 miles
0.7 when detour is < 3 miles
0.9 when route crossed is a railroad

*Note: Twin structures on the Interstate are coded with a one mile detour. This assumes that one structure will be the detour bridge. We will assume both structures are not useable and assign it a default value of 0.9 for preliminary screening.

Ncross = Factor representing criticality of detour for the route carried due to traffic congestion.

$$N_{cross} = [ADT_{cross}/6000]^{0.25}$$

ADTcross= Average Daily Traffic of route crossed by bridge, or
If RTcross is a railroad then ADTcross = 10,000
If ADT not available the ADTcross = 100

L = Length of bridge

RVcross = Factor representing a river crossing only. (NBI data item 42 = 5)

Rvcross = L/1000

Range of Importance Index "I"

Importance Index I can be as high as **4.15** when:

- Route carried by the bridge is Interstate, or a principle arterial in an urban setting (i.e. NBI item no. 26 = 1, 11, 12, or 14).
- Detour length for route carried is ten miles or more or a twin structure on the Interstate.
- ADT of the route carried is 20,000.
- Route crossed by the bridge is Interstate, or a principle arterial in an urban setting (i.e. NBI item no. 26 = 1, 11, 12, or 14).
- Detour length for route crossed is ten miles or more or a twin structure on the Interstate.
- ADT of the route crossed is 20,000.
- Bridge length is 1000 feet.

Importance Index I can be as low as **0.32** when:

- Route carried by the bridge is not a principle arterial
- Detour length for route carried is three miles or less.
- ADT of the route carried is 20.
- No route crossed.
- Bridge length is 50 feet.

ATTACHMENT I-E

Define Seismic Retrofits

Minor seismic retrofit will usually be limited to seismic restrainers, dynamic isolation bearings, widening of beam seats and for the most part will be limited to work at or above the beam seats. The cost of minor retrofits will generally not exceed 25% of the cost of a new seismically designed structure.

Major seismic retrofits involves such items as strengthening columns, piers, bent caps, etc. It will generally include work below the level of the beam seats and may include work requiring cofferdams. The cost of major retrofits will generally not exceed 50% of the cost of a new structure seismically designed structure.

If the cost of a seismic retrofit approaches 50% of the cost of a new structure an in depth cost analysis must be completed. It will include life cycle cost analysis and alternative methods and levels of retrofitting.

ATTACHMENT 1-F

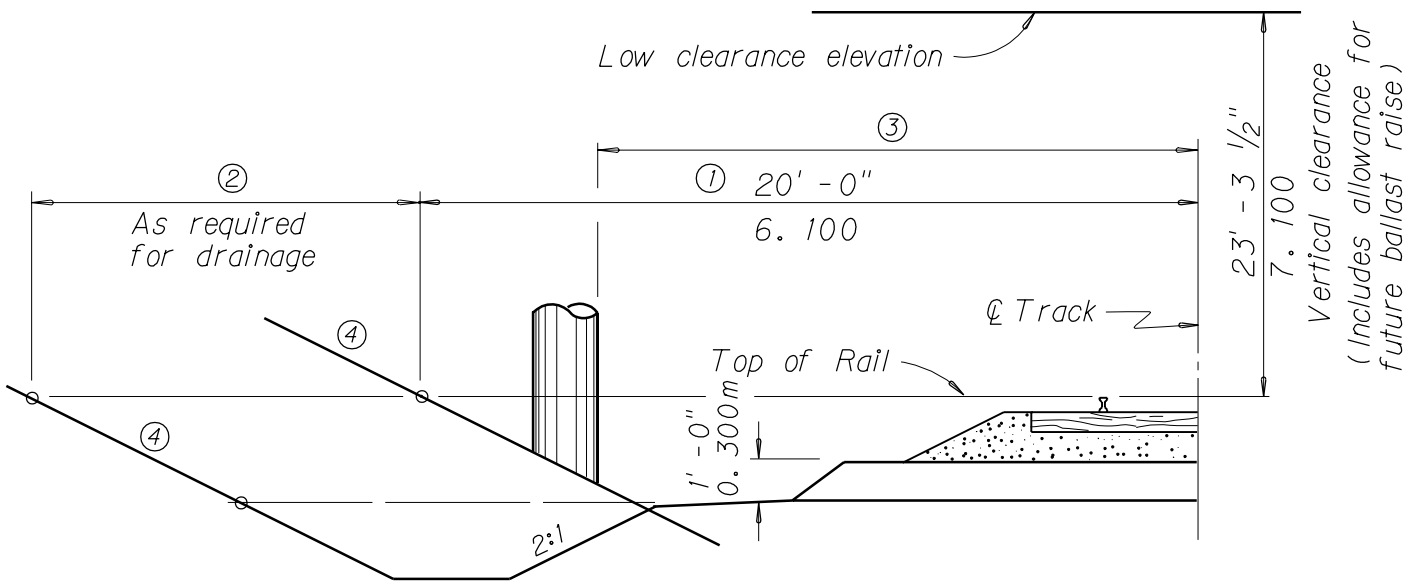

RAILROAD CLEARANCES

- ① When providing more than 20 ft (6.10m) justify the additional distance by documenting the need for off-track equipment roads, heavy snow accumulation or longitudinal drainage. In the case of an access road, provide at least 8ft (2.50m) of additional clearance.
- ② Meet with Railroad staff soon after receiving the survey to discuss drainage requirements
- ③ Set the faces of bents a minimum of 18 ft (5.500m) from the CL of an industrial or branch line and 25 ft (7.700m) from the CL of a main line. Determine horizontal clearances at the initial meeting with railroad staff for multiple track installations, railroad yards and when rehabilitating or widening an overpass.

Bents less than 25 ft (7.700m) from the centerline of a railroad track must incorporate heavy construction or include the protection of a reinforced concrete crash wall. Crash walls must have a minimum height of 6.0 ft (1.850m) above the top of rail. Design crash walls at least 2.5 ft (0.770m) thick and at least 12 ft (3.700m) long.

- ④ Set the slope to fit the soil type. For the sake of stability, make the slope no steeper than 2:1 unless paving the slope or designing a reinforced embankment.

ATTACHMENT I-G

MONTANA BRIDGE RAIL POLICY AND PRACTICE AUGUST 1988

This policy and practice statement will provide additional clarification regarding the Montana Department of Transportation's bridge rail policy which our FHWA Division office concurs in. Since our meeting of January 13, between MDT and the FHWA Division office, Mr. Morgan has concurred in Mr. Loveall's additional guidelines to AASHTO's proposed guide specifications for bridge railings. The additional guideline specifications state, in part, that railing designed and built subsequent to the institution of the 1964 Interim AASHTO Specifications railing provisions are not subject to replacement, provided its performance record is proven satisfactory. Existing Montana bridge rail that does not meet the 1964 specification will be required to be upgraded to a crashworthy design.

Since the preface of the guide specifications clarifies that the guide is for new bridges and for bridges being rehabilitated to the extent that railing replacement is obviously appropriate, therefore, on a case by case basis bridge rails designed and constructed subsequent to the 1964 AASHTO Specifications may be retained in service. Site specific data and railing performance data will need to be reviewed to determine whether to replace or retrofit the existing bridge rail to a crashworthy configuration or leave the existing bridge rail in place.

If the bridge rail has been previously blocked out and only requires repairs which are normally performed by MDT maintenance forces, then the rail can remain in place provided the rail will be repaired before the contract is let. The period between the field check stage and letting date should allow adequate time for the rail to be repaired.

Montana's Type No. 5 bridge rail with a 6 in. (150 mm) offset was designed prior to the 1964 Interim Specifications and therefore should be retrofitted. A blocked out thrie beam is currently being used. The Type No. 5 rail with a 3 in. (75 mm) offset to rail from curb was designed after the 1964 Interim Specifications. Therefore this rail, contingent on a review of each site and performance data, can remain in place.

Montana's Type No. 3, Type No. 4, and concrete post bridge rails were designed prior to 1964. If these rails have not been blocked out, they should be replaced or retrofitted. The Type No. 3 rail, when within a Federal-aid project, is being replaced with a cast-in-place, concrete barrier. The T4 and concrete post bridge rails are retrofitted, with Division office approval, by blocking out a thrie beam to the face of the curb.

An existing steel beam bridge rail, SBBR, that is blocked out to the curb can remain in place. Again, site specific data regarding railing performance and condition of existing rail components will need to be evaluated to determine if the blocked out SBBR can be left in place. If the existing SBBR is not blocked out then a cast-in-place Jersey barrier will be constructed. The blocked out SBBR's first steel post will be modified to accept Montana's crash worthy approach rail. The blocked out SBBR will still be treated as a bridge rail to remain in place since this modification to the first bridge rail post only is only for accepting a crashworthy approach rail.

An existing timber bridge rail that is blocked out to the curb does not satisfy the requirements of the 1964 provisions of AASHTO's Interim Bridge Railing Specifications. Also an existing timber bridge rail that is not blocked out to the curb does not satisfy these requirements. In accordance with previous correspondence from our Regional and Washington FHWA offices, the precast concrete barrier, originally proposed by the MDT, is not an acceptable retrofit. A continuous, cast-in-place concrete barrier rail secured to the deck, proposed by the MDT, is an acceptable solution but was found to cause excessive weight on the bridge reducing live load capacities. In 1989 Montana Department of Transportation submitted and received approval from FHWA for a modified Texas T101 attachment for timber bridges. The rail design has been used successfully on MDT's timber bridges since approval.

In accordance with the proposed policy, bridge rails for new bridge construction or bridge replacement are being constructed to a crashworthy design. Our Regional FHWA office concurs with holding off on Montana's crash testing of the T5 rail with a 3 in. (75 mm) offset and the SBBR until the proposed guide specifications are adopted. The adopted specifications may not require crash testing of rails designed after the 1964 Interim Bridge Specifications.

The 1988 bid estimates for retrofitting bridge rails with a blocked out thrie beam have averaged about \$16.00/ft (\$52.50 per linear meter). Assuming traffic control to be 20% results in a total unit cost of \$20.00/ft (\$65.50 per linear meter) for blocking out with a thrie beam.

The 1988 bid estimates for placing a cast-in-place concrete barrier have averaged \$85/ft (\$280 per linear meter). Assuming traffic control to be 20% results in a total unit cost of \$102/ft (\$335 per linear meter) for the concrete barrier.

For the remaining August through December 1988 lettings the cost to upgrade bridge rail to a crashworthy configuration within Federal Aid projects is estimated to be \$150,000.

Attachment 1-G

Summary of Guardrail Retrofit Policy by FHWA

- 1) MONTANA SBR-T3 Retrofit with cast-in-place concrete barriers.

- 2) MONTANA SBR-T4 Thrie Beam retrofit upon FHWA Division office approval only. Dependent upon needed repairs, performance and other criteria.

- 3) MONTANA SBR-T5 Designed prior to the 1964 AASHTO Interims – (Curb to Rail Spacing of 6 in. (150 mm)) – Use blocked out thrie beam retrofit.

 Designed after the 1964 AASHTO Interims – (Curb to Rail Spacing of 3 in. (75 mm)) – No retrofit needed. This system can remain as is.

- 4) MONTANA SBBR If this rail system is blocked out to the face of the rail, no retrofit is needed. This will also depend on the condition and the performance of the existing rail.

 If this rail system is not blocked out to the face of the curb, then a cast-in-place concrete barrier rail is required. New approach rail corresponding to a crashworthy bridge rail is also required.

- 5) TIMBER RAILS Existing timber bridges with timber posts and rails or with timber posts and previously blocked out metal rails will be retrofit with a modified version of the Texas T101. This Rail system was adopted and approved by FHWA in 1989 for use in Montana on exiting timber structures for federal aid projects.

 Retrofit requires removal of the existing posts, curb, rail and plant mix surfacing (PMS) and then placement of the new rail and PMS. This retrofit can be adjusted to accommodate different scopes of roadwork from typical mill and fill, pavement preservation and seal and cover.